

# Intel<sup>®</sup> Core<sup>™</sup> i7-900 Desktop Processor Extreme Edition Series and Intel<sup>®</sup> Core<sup>™</sup> i7-900 Desktop Processor Series on 32-nm Process

Datasheet, Volume 1

---

*June 2011*



INFORMATION IN THIS DOCUMENT IS PROVIDED IN CONNECTION WITH INTEL PRODUCTS. NO LICENSE, EXPRESS OR IMPLIED, BY ESTOPPEL OR OTHERWISE, TO ANY INTELLECTUAL PROPERTY RIGHTS IS GRANTED BY THIS DOCUMENT. EXCEPT AS PROVIDED IN INTEL'S TERMS AND CONDITIONS OF SALE FOR SUCH PRODUCTS, INTEL ASSUMES NO LIABILITY WHATSOEVER, AND INTEL DISCLAIMS ANY EXPRESS OR IMPLIED WARRANTY, RELATING TO SALE AND/OR USE OF INTEL PRODUCTS INCLUDING LIABILITY OR WARRANTIES RELATING TO FITNESS FOR A PARTICULAR PURPOSE, MERCHANTABILITY, OR INFRINGEMENT OF ANY PATENT, COPYRIGHT OR OTHER INTELLECTUAL PROPERTY RIGHT. INTEL PRODUCTS ARE NOT INTENDED FOR USE IN MEDICAL, LIFE SAVING, OR LIFE SUSTAINING APPLICATIONS.

Intel may make changes to specifications and product descriptions at any time, without notice.

Designers must not rely on the absence or characteristics of any features or instructions marked "reserved" or "undefined." Intel reserves these for future definition and shall have no responsibility whatsoever for conflicts or incompatibilities arising from future changes to them.

The Intel® Core™ i7-900 desktop processor Extreme Edition series on 32-nm process may contain design defects or errors known as errata which may cause the product to deviate from published specifications.

<sup>A</sup>Intel processor numbers are not a measure of performance. Processor numbers differentiate features within each processor family, not across different processor families. See [http://www.intel.com/products/processor\\_number](http://www.intel.com/products/processor_number) for details. Over time processor numbers will increment based on changes in clock, speed, cache, FSB, or other features, and increments are not intended to represent proportional or quantitative increases in any particular feature. Current roadmap processor number progression is not necessarily representative of future roadmaps. See [www.intel.com/products/processor\\_number](http://www.intel.com/products/processor_number) for details.

Hyper-Threading Technology requires a computer system with a processor supporting HT Technology and an HT Technology-enabled chipset, BIOS and operating system. Performance will vary depending on the specific hardware and software you use. For more information including details on which processors support HT Technology, see [http://www.intel.com/products/ht/hyperthreading\\_more.htm](http://www.intel.com/products/ht/hyperthreading_more.htm)

Intel® 64 requires a computer system with a processor, chipset, BIOS, operating system, device drivers and applications enabled for Intel® 64. Processor will not operate (including 32-bit operation) without an Intel 64-enabled BIOS. Performance will vary depending on your hardware and software configurations. See [www.intel.com/info/em64t](http://www.intel.com/info/em64t) for more information including details on which processors support Intel® 64 or consult with your system vendor for more information.

± Intel® Virtualization Technology requires a computer system with a processor, chipset, BIOS, virtual machine monitor (VMM) and for some uses, certain platform software, enabled for it. Functionality, performance or other benefit will vary depending on hardware and software configurations. Intel Virtualization Technology-enabled VMM applications are currently in development.

Enabling Execute Disable Bit functionality requires a PC with a processor with Execute Disable Bit capability and a supporting operating system. Check with your PC manufacturer on whether your system delivers Execute Disable Bit functionality.

Enhanced Intel® SpeedStep Technology. See the [Processor Spec Finder](#) or contact your Intel representative for more information.

Intel® Turbo Boost Technology requires a PC with a processor with Intel Turbo Boost Technology capability. Intel Turbo Boost Technology performance varies depending on hardware, software and overall system configuration. Check with your PC manufacturer on whether your system delivers Intel Turbo Boost Technology. For more information, see [www.intel.com](http://www.intel.com).

Contact your local Intel sales office or your distributor to obtain the latest specifications and before placing your product order.

Intel, Intel SpeedStep, Intel Core, and the Intel logo are trademarks or registered trademarks of Intel Corporation or its subsidiaries in the United States and other countries.

\*Other names and brands may be claimed as the property of others.

Copyright © 2010–2011 Intel Corporation.

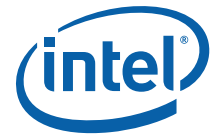

# Contents

---

<b>1</b>	<b>Introduction</b>	9
1.1	Terminology	10
1.2	References	11
<b>2</b>	<b>Electrical Specifications</b>	13
2.1	Intel® QuickPath Interconnect (Intel® QPI) Differential Signaling	13
2.2	Power and Ground Lands	13
2.3	Decoupling Guidelines	13
2.3.1	V <sub>CC</sub> , V <sub>TTA</sub> , V <sub>TTD</sub> , V <sub>DDQ</sub> Decoupling	14
2.4	Processor Clocking (BCLK_DP, BCLK_DN)	14
2.4.1	PLL Power Supply	14
2.5	Voltage Identification (VID)	15
2.6	Reserved or Unused Signals	18
2.7	Signal Groups	19
2.8	Test Access Port (TAP) Connection	20
2.9	Platform Environmental Control Interface (PECI) DC Specifications	21
2.9.1	DC Characteristics	21
2.9.2	Input Device Hysteresis	22
2.10	Absolute Maximum and Minimum Ratings	22
2.11	Processor DC Specifications	23
2.11.1	DC Voltage and Current Specification	24
2.11.2	V <sub>CC</sub> Overshoot Specification	31
2.11.3	Die Voltage Validation	31
2.12	Intel® QuickPath Interconnect (Intel® QPI) Specifications	32
<b>3</b>	<b>Package Mechanical Specifications</b>	35
3.1	Package Mechanical Drawing	35
3.2	Processor Component Keep-Out Zones	38
3.3	Package Loading Specifications	38
3.4	Package Handling Guidelines	38
3.5	Package Insertion Specifications	38
3.6	Processor Mass Specification	39
3.7	Processor Materials	39
3.8	Processor Markings	39
3.9	Processor Land Coordinates	40
<b>4</b>	<b>Land Listing</b>	41
<b>5</b>	<b>Signal Descriptions</b>	71
<b>6</b>	<b>Thermal Specifications</b>	75
6.1	Package Thermal Specifications	75
6.1.1	Thermal Specifications	75
6.1.1.1	Specification for Operation Where Digital Thermal Sensor Exceeds T <sub>CONTROL</sub>	79
6.1.2	Thermal Metrology	80
6.2	Processor Thermal Features	81
6.2.1	Processor Temperature	81
6.2.2	Adaptive Thermal Monitor	81
6.2.2.1	Frequency/VID Control	82
6.2.2.2	Clock Modulation	83
6.2.2.3	Immediate Transition to combined TM1 and TM2	83
6.2.2.4	Critical Temperature Flag	83
6.2.2.5	PROCHOT# Signal	83
6.2.3	THERMTRIP# Signal	84



6.3	Platform Environment Control Interface (PECI) .....	84
6.3.1	Introduction .....	84
6.3.1.1	Fan Speed Control with Digital Thermal Sensor .....	85
6.3.1.2	Processor Thermal Data Sample Rate and Filtering .....	85
6.3.2	PECI Specifications .....	86
6.3.2.1	PECI Device Address .....	86
6.3.2.2	PECI Command Support .....	86
6.3.2.3	PECI Fault Handling Requirements .....	86
6.3.2.4	PECI GetTemp0() Error Code Support .....	86
6.4	Storage Conditions Specifications .....	87
<b>7</b>	<b>Features</b> .....	<b>89</b>
7.1	Power-On Configuration (POC) .....	89
7.2	Clock Control and Low Power States .....	89
7.2.1	Thread and Core Power State Descriptions .....	90
7.2.1.1	C0 State .....	90
7.2.1.2	C1/C1E State .....	90
7.2.1.3	C3 State .....	91
7.2.1.4	C6 State .....	91
7.2.2	Package Power State Descriptions .....	91
7.2.2.1	Package C0 State .....	91
7.2.2.2	Package C1/C1E State .....	91
7.2.2.3	Package C3 State .....	91
7.2.2.4	Package C6 State .....	92
7.3	Sleep States .....	92
7.4	ACPI P-States (Intel® Turbo Boost Technology) .....	92
7.5	Enhanced Intel SpeedStep® Technology .....	93
<b>8</b>	<b>Boxed Processor Specifications</b> .....	<b>95</b>
8.1	Introduction .....	95
8.2	Mechanical Specifications .....	96
8.2.1	Boxed Processor Cooling Solution Dimensions .....	96
8.2.2	Boxed Processor Fan Heatsink Weight .....	98
8.2.3	Boxed Processor Retention Mechanism and Heatsink Attach Clip Assembly .....	98
8.3	Electrical Requirements .....	98
8.3.1	Fan Heatsink Power Supply .....	98
8.4	Thermal Specifications .....	99
8.4.1	Boxed Processor Cooling Requirements .....	99
8.4.2	Variable Speed Fan .....	101



## Figures

1-1	High-Level View of Processor Interfaces .....	9
2-1	Active ODT for a Differential Link Example .....	13
2-2	Input Device Hysteresis .....	22
2-3	V <sub>CC</sub> Static and Transient Tolerance Load Lines.....	26
2-4	V <sub>TT</sub> Static and Transient Tolerance Load Line .....	28
2-5	V <sub>CC</sub> Overshoot Example Waveform .....	31
3-1	Processor Package Assembly Sketch .....	35
3-2	Processor Package Drawing (Sheet 1 of 2) .....	36
3-3	Processor Package Drawing (Sheet 2 of 2) .....	37
3-4	Processor Top-side Markings .....	39
3-5	Processor Land Coordinates and Quadrants, Top View .....	40
6-1	Intel® Core™ i7-900 Desktop Processor Extreme Edition Series Thermal Profile .....	77
6-2	Intel® Core™ i7-900 Desktop Processor Series Thermal Profile .....	78
6-3	Thermal Test Vehicle (TTV) Case Temperature (T <sub>CASE</sub> ) Measurement Location .....	80
6-4	Frequency and Voltage Ordering.....	82
7-1	Power State.....	90
8-1	Mechanical Representation of the Boxed Processor.....	95
8-2	Space Requirements for the Boxed Processor (side view).....	96
8-3	Space Requirements for the Boxed Processor (top view) .....	97
8-4	Space Requirements for the Boxed Processor (overall view) .....	97
8-5	Boxed Processor Fan Heatsink Power Cable Connector Description .....	98
8-6	Baseboard Power Header Placement Relative to Processor Socket .....	99
8-7	Boxed Processor Fan Heatsink Airspace Keepout Requirements (top view) .....	100
8-8	Boxed Processor Fan Heatsink Airspace Keepout Requirements (side view) .....	100
8-9	Boxed Processor Fan Heatsink Set Points.....	101



## Tables

1-1	References	11
2-1	Voltage Identification Definition	16
2-2	Market Segment Selection Truth Table for MS_ID[2:0]	18
2-3	Signal Groups	19
2-4	Signals with ODT	20
2-5	PECI DC Electrical Limits	21
2-6	Processor Absolute Minimum and Maximum Ratings	23
2-7	Voltage and Current Specifications	24
2-8	V <sub>CC</sub> Static and Transient Tolerance	25
2-9	V <sub>TT</sub> Voltage Identification (VID) Definition	26
2-10	V <sub>TT</sub> Static and Transient Tolerance	27
2-11	DDR3 Signal Group DC Specifications	28
2-12	RESET# Signal DC Specifications	29
2-13	TAP Signal Group DC Specifications	29
2-14	PWRGOOD Signal Group DC Specifications	30
2-15	Control Sideband Signal Group DC Specifications	30
2-16	VCC Overshoot Specifications	31
2-17	Intel® QuickPath Interconnect (Intel QPI) Specifications	32
2-18	Parameter Values for Intel® QuickPath Interconnect (Intel QPI) Channel at 6.4 GT/s	33
3-1	Processor Loading Specifications	38
3-2	Package Handling Guidelines	38
3-3	Processor Materials	39
4-1	Land Listing by Land Name	41
4-2	Land Listing by Land Number	56
5-1	Signal Definitions	71
6-1	Processor Thermal Specifications	76
6-2	Intel® Core™ i7-900 Desktop Processor Extreme Edition Series Thermal Profile	77
6-3	Intel® Core™ i7-900 Desktop Processor Series Thermal Profile	78
6-4	Thermal Solution Performance above T <sub>CONTROL</sub>	79
6-5	Supported PECI Command Functions and Codes	86
6-6	GetTemp0() Error Codes	86
6-7	Storage Condition Ratings	87
7-1	Power On Configuration Signal Options	89
7-2	Coordination of Thread Power States at the Core Level	90
7-3	Processor S-States	92
8-1	Fan Heatsink Power and Signal Specifications	99
8-2	Fan Heatsink Power and Signal Specifications	101

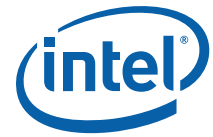

## Revision History

---

Revision Number	Description	Date
001	<ul style="list-style-type: none"><li>Initial release</li></ul>	March 2010
002	<ul style="list-style-type: none"><li>Added Intel® Core™ i7-970 desktop processor series</li></ul>	July 2010
003	<ul style="list-style-type: none"><li>Added Intel® Core™ i7-990X desktop processor Extreme Edition</li><li>Added Intel® Core™ i7-980 desktop processor</li></ul>	June 2011

§





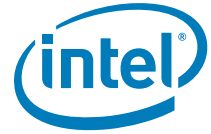

# 1 Introduction

The Intel® Core™ i7-900 desktop processor Extreme Edition series and Intel® Core™ i7-900 desktop processor series on 32-nm process processor is intended for high performance, high-end desktop systems. Several architectural and microarchitectural enhancements have been added to this processor including six processor cores in the processor package and increased shared cache.

The Intel® Core™ i7-900 desktop processor Extreme Edition series and Intel® Core™ i7-970 desktop processor series on 32-nm process is a desktop multi-core processor with these key technologies:

- Integrated memory controller
- Point-to-point link interface based on Intel QuickPath Interconnect (Intel QPI)

Figure 1-1 shows the interfaces used with these new technologies.

**Figure 1-1. High-Level View of Processor Interfaces**

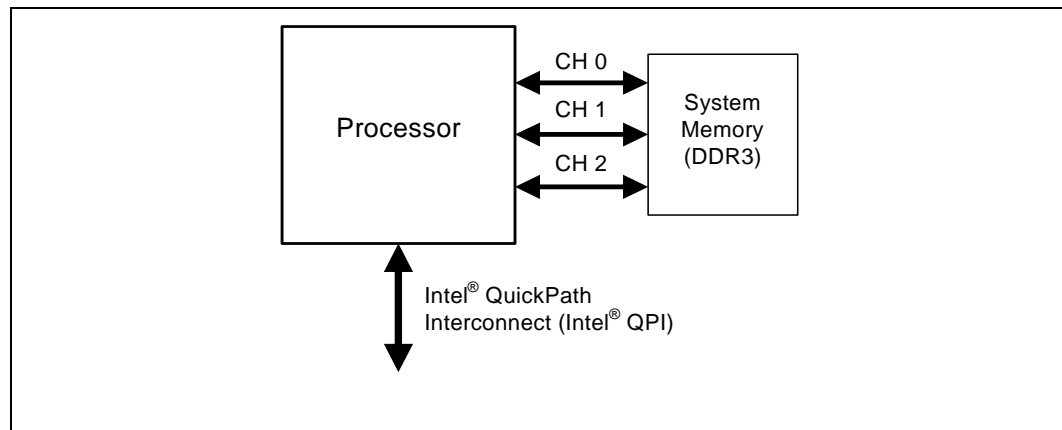

**Note:** In this document the Intel® Core™ i7-900 desktop processor Extreme Edition series on 32-nm process will be referred to as “the processor.”

**Note:** The Intel® Core™ i7-900 desktop processor Extreme Edition series on 32-nm process refers to the Intel® Core™ i7-980X and i7-990X desktop processor Extreme Edition.

**Note:** The Intel® Core™ i7-900 desktop processor series on 32-nm process refers to the Intel® Core™ i7-980 and i7-970 desktop processors.

The processor is optimized for performance with the power efficiency of a low-power microarchitecture.

This document provides DC electrical specifications, differential signaling specifications, pinout and signal definitions, package mechanical specifications and thermal requirements, and additional features pertinent to the implementation and operation of the processor.

The processor is a multi-core processor built on the 32-nm process technology, that uses up to 130 W thermal design power (TDP). The processor features an Intel QPI point-to-point link capable of up to 6.4 GT/s, 12 MB Level 3 cache, and an integrated memory controller.

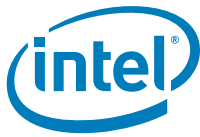

The processor supports all the existing Streaming SIMD Extensions 2 (SSE2), Streaming SIMD Extensions 3 (SSE3) and Streaming SIMD Extensions 4 (SSE4). The processor supports several Advanced Technologies: Intel® 64 Technology (Intel® 64), Enhanced Intel SpeedStep® Technology, Intel® Virtualization Technology (Intel® VT), Turbo Boost Technology, and Hyper-Threading Technology.

## 1.1 Terminology

A '#' symbol after a signal name refers to an active low signal, indicating a signal is in the active state when driven to a low level. For example, when RESET# is low, a reset has been requested. Conversely, when VTTWRGOOD is high, the V<sub>TT</sub> power rail is stable.

'\_N' and '\_P' after a signal name refers to a differential pair.

Commonly used terms are explained here for clarification:

- **Intel® Core™ i7-900 desktop processor Extreme Edition series and Intel® Core™ i7-900 desktop processor series on 32-nm process** — The entire product, including processor substrate and integrated heat spreader (IHS).
- **1366-land LGA package** — The processor is available in a Flip-Chip Land Grid Array (FC-LGA) package, consisting of the processor mounted on a land grid array substrate with an integrated heat spreader (IHS).
- **LGA1366 Socket** — The processor (in the LGA 1366 package) mates with the system board through this surface mount, 1366-contact socket.
- **DDR3** — Double Data Rate 3 Synchronous Dynamic Random Access Memory (SDRAM) is the name of the new DDR memory standard that is being developed as the successor to DDR2 SDRAM.
- **Intel® QuickPath Interconnect (Intel® QPI)**— Intel QPI is a cache-coherent, point-to-point link-based electrical interconnect specification for Intel processors and chipsets.
- **Intel® QuickPath Technology Memory Controller** — A memory controller that is integrated into the processor die.
- **Integrated Heat Spreader (IHS)** — A component of the processor package used to enhance the thermal performance of the package. Component thermal solutions interface with the processor at the IHS surface.
- **Functional Operation** — Refers to the normal operating conditions in which all processor specifications, including DC, AC, signal quality, mechanical, and thermal, are satisfied.
- **Enhanced Intel SpeedStep® Technology** — Enhanced Intel SpeedStep Technology allows the operating system to reduce power consumption when performance is not needed.
- **Execute Disable Bit** — Execute Disable allows memory to be marked as executable or non-executable when combined with a supporting operating system. If code attempts to run in non-executable memory, the processor raises an error to the operating system. This feature can prevent some classes of viruses or worms that exploit buffer overrun vulnerabilities and can thus help improve the overall security of the system. See the *Intel® Architecture Software Developer's Manual* for more detailed information. Refer to <http://developer.intel.com/> for future reference on up to date nomenclatures.
- **Intel® 64 Architecture** — An enhancement to the Intel IA-32 architecture, allowing the processor to execute operating systems and applications written to



take advantage of Intel 64. Further details on the Intel 64 architecture and programming model can be found at <http://developer.intel.com/technology/intel64/>.

- **Intel® Virtualization Technology (Intel® VT)** — A set of hardware enhancements to Intel server and client platforms that can improve virtualization solutions. Intel® VT provides a foundation for widely-deployed virtualization solutions and enables a more robust hardware assisted virtualization solution. More information can be found at: <http://www.intel.com/technology/virtualization/>
- **Unit Interval (UI)** — Signaling convention that is binary and unidirectional. In this binary signaling, one bit is sent for every edge of the forwarded clock, whether it is a rising edge or a falling edge. If a number of edges are collected at instances  $t_1, t_2, t_n, \dots, t_k$  then the UI at instance “n” is defined as:

$$UI_n = t_n - t_{n-1}$$

- **Jitter** — Any timing variation of a transition edge or edges from the defined Unit Interval.
- **Storage Conditions** — Refers to a non-operational state. The processor may be installed in a platform, in a tray, or loose. Processors may be sealed in packaging or exposed to free air. Under these conditions, processor lands should not be connected to any supply voltages, have any I/Os biased, or receive any clocks.
- **OEM** — Original Equipment Manufacturer.

## 1.2 References

Material and concepts available in the following documents may be beneficial when reading this document.

**Table 1-1. References**

Document	Location
<i>Intel® Core™ i7-900 Desktop Processor Extreme Edition Series and Intel® Core™ i7-900 Desktop Processor Series on 32-nm Process Specification Update</i>	<a href="http://www.intel.com/Assets/PDF/specupdate/323254.pdf">http://www.intel.com/Assets/PDF/specupdate/323254.pdf</a>
<i>Intel® Core™ i7-900 Desktop Processor Extreme Edition Series on 32-nm Process Datasheet, Volume 2</i>	<a href="http://download.intel.com/design/processor/datashts/323253.pdf">http://download.intel.com/design/processor/datashts/323253.pdf</a>
<i>Intel® Core™ i7-900 Desktop Processor Extreme Edition Series and Intel® Core™ i7-900 Desktop Processor Series and LGA1366 Socket Thermal and Mechanical Design Guide</i>	<a href="http://download.intel.com/design/processor/designex/320837.pdf">http://download.intel.com/design/processor/designex/320837.pdf</a>
<i>Intel X58 Express Chipset Datasheet</i>	<a href="http://www.intel.com/Assets/PDF/datasheet/320838.pdf">http://www.intel.com/Assets/PDF/datasheet/320838.pdf</a>
<i>AP-485, Intel® Processor Identification and the CPUID Instruction</i>	<a href="http://www.intel.com/design/processor/applnots/241618.htm">http://www.intel.com/design/processor/applnots/241618.htm</a>
<i>IA-32 Intel® Architecture Software Developer's Manual</i> <ul style="list-style-type: none"> <li>• Volume 1: Basic Architecture</li> <li>• Volume 2A: Instruction Set Reference, A-M</li> <li>• Volume 2B: Instruction Set Reference, N-Z</li> <li>• Volume 3A: System Programming Guide, Part 1</li> <li>• Volume 3B: Systems Programming Guide, Part 2</li> </ul>	<a href="http://www.intel.com/products/processor/manuals/">http://www.intel.com/products/processor/manuals/</a>

**Notes:**

1. Contact your Intel representative to receive the latest revisions of these documents.
2. Document is available publicly at <http://developer.intel.com>.
3. Document not available at time of printing.
4. The *LGA1366 Socket and Heatsink Keepout Zones – Mechanical Models* will be made available electronically.



§

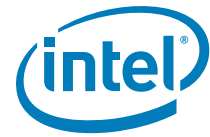

## 2 Electrical Specifications

### 2.1 Intel® QuickPath Interconnect (Intel® QPI) Differential Signaling

The processor provides an Intel QPI port for high speed serial transfer between other Intel QPI-enabled components. The Intel QPI port consists of two unidirectional links (for transmit and receive). Intel QPI uses a differential signalling scheme where pairs of opposite-polarity (D\_P, D\_N) signals are used.

On-die termination (ODT) provided on the processor silicon and termination is to  $V_{SS}$ . Intel chipsets also provide ODT; thus, eliminating the need to terminate the Intel QPI links on the system board.

Intel strongly recommends performing analog simulations of the Intel QPI interface.

Figure 2-1 illustrates the active ODT. Signal listings are included in Table 2-3 and Table 2-4. See Chapter 5 for the pin signal definitions. All Intel QPI signals are in the differential signal group.

Figure 2-1. Active ODT for a Differential Link Example

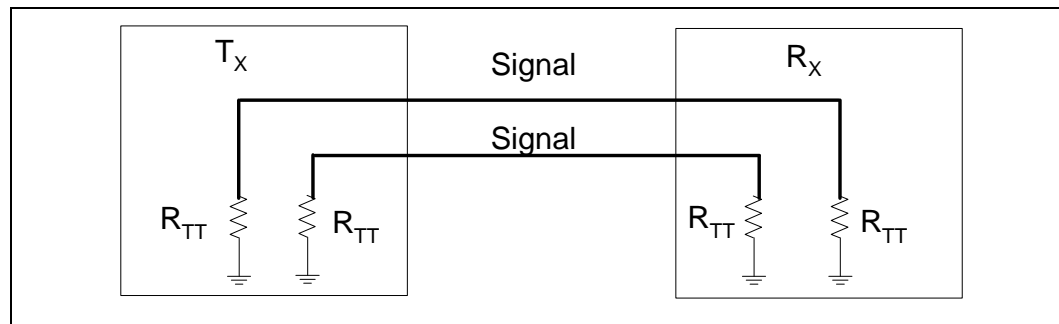

### 2.2 Power and Ground Lands

For clean on-chip processor core power distribution, the processor has 210 VCC pads and 119 VSS pads associated with  $V_{CC}$ ; 8 VTTA pads and 5 VSS pads associated with  $V_{TTA}$ ; 28 VTTD pads and 17 VSS pads associated with  $V_{TTD}$ ; 28 VDDQ pads and 17 VSS pads associated with  $V_{DDQ}$ ; and 3 VCCPLL pads. All VCCP, VTTA, VTTD, VDDQ, and VCCPLL lands must be connected to their respective processor power planes, while all VSS lands must be connected to the system ground plane. The processor VCC lands must be supplied with the voltage determined by the processor Voltage Identification (VID) signals. Table 2-1 specifies the voltage level for the various VID.

### 2.3 Decoupling Guidelines

Due to its large number of transistors and high internal clock speeds, the processor is capable of generating large current swings between low and full power states. This may cause voltages on power planes to sag below their minimum values if bulk decoupling is not adequate. Larger bulk storage ( $C_{BULK}$ ), such as electrolytic capacitors, supply current during longer lasting changes in current demand; such as, coming out of an idle condition. Similarly, capacitors act as a storage well for current when entering an idle

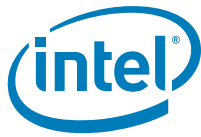

condition from a running condition. Care must be taken in the baseboard design to ensure that the voltage provided to the processor remains within the specifications listed in [Table 2-7](#). Failure to do so can result in timing violations or reduced lifetime of the processor.

### 2.3.1 $V_{CC}$ , $V_{TTA}$ , $V_{TTD}$ , $V_{DDQ}$ Decoupling

Voltage regulator solutions need to provide bulk capacitance and the baseboard designer must assure a low interconnect resistance from the regulator to the LGA1366 socket. Bulk decoupling must be provided on the baseboard to handle large current swings. The power delivery solution must insure the voltage and current specifications are met (as defined in [Table 2-7](#)).

## 2.4 Processor Clocking (BCLK\_DP, BCLK\_DN)

The processor core, Intel QPI, and integrated memory controller frequencies are generated from BCLK\_DP and BCLK\_DN. Unlike previous processors based on front side bus architecture, there is no direct link between core frequency and Intel QPI link frequency (such as, no core frequency to Intel QPI multiplier). The processor maximum core frequency, Intel QPI link frequency and integrated memory controller frequency, are set during manufacturing. It is possible to override the processor core frequency setting using software. This permits operation at lower core frequencies than the factory set maximum core frequency.

The processor's maximum non-turbo core frequency is configured during power-on reset by using values stored internally during manufacturing. The stored value sets the highest core multiplier at which the particular processor can operate. If lower maximum non-turbo speeds are desired, the appropriate ratio can be configured using the CLOCK\_FLEX\_MAX MSR.

The processor uses differential clocks (BCLK\_DP, BCLK\_DN). Clock multiplying within the processor is provided by the internal phase locked loop (PLL) that requires a constant frequency BCLK\_DP, BCLK\_DN input, with exceptions for spread spectrum clocking. The processor core frequency is determined by multiplying the ratio by 133 MHz.

### 2.4.1 PLL Power Supply

An on-die PLL filter solution is implemented on the processor. Refer to [Table 2-7](#) for DC specifications.

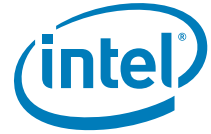

## 2.5 Voltage Identification (VID)

The Voltage Identification (VID) specification for the processor is defined by the *Voltage Regulator Down (VRD) 11.1 Design Guidelines*. The voltage set by the VID signals is the reference voltage regulator output voltage to be delivered to the processor VCC pins. VID signals are CMOS push/pull drivers. Refer to [Table 2-15](#) for the DC specifications for these signals. The VID codes will change due to temperature and/or current load changes in order to minimize the power of the part. A voltage range is provided in [Table 2-7](#). The specifications have been set such that one voltage regulator can operate with all supported frequencies.

Individual processor VID values may be set during manufacturing such that two devices at the same core frequency may have different default VID settings. This is reflected by the VID range values provided in [Table 2-1](#).

The processor uses eight voltage identification signals, VID[7:0], to support automatic selection of voltages. [Table 2-1](#) specifies the voltage level corresponding to the state of VID[7:0]. A '1' in this table refers to a high voltage level and a '0' refers to a low voltage level. If the processor socket is empty (VID[7:0] = 11111111), or the voltage regulation circuit cannot supply the voltage that is requested, the voltage regulator must disable itself. See the *Voltage Regulator Down (VRD) 11.1 Design Guidelines* for further details.

The processor provides the ability to operate while transitioning to an adjacent VID and its associated processor core voltage ( $V_{CC}$ ). This will represent a DC shift in the loadline. It should be noted that a low-to-high or high-to-low voltage state change will result in as many VID transitions as necessary to reach the target core voltage. Transitions above the maximum specified VID are not permitted. [Table 2-8](#) includes VID step sizes and DC shift ranges. Minimum and maximum voltages must be maintained as shown in [Table 2-8](#).

The VR used must be capable of regulating its output to the value defined by the new VID. DC specifications for dynamic VID transitions are included in [Table 2-7](#) and [Table 2-8](#). Refer to the *Voltage Regulator Down (VRD) 11.1 Design Guidelines* for further details.

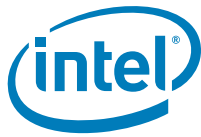

Table 2-1. Voltage Identification Definition (Sheet 1 of 2)

VID 7	VID 6	VID 5	VID 4	VID 3	VID 2	VID 1	VID 0	V <sub>CC_MAX</sub>	VID 7	VID 6	VID 5	VID 4	VID 3	VID 2	VID 1	VID 0	V <sub>CC_MAX</sub>
0	0	0	0	0	0	0	0	OFF	0	1	0	1	1	0	1	1	1.04375
0	0	0	0	0	0	0	1	OFF	0	1	0	1	1	1	0	0	1.03750
0	0	0	0	0	0	1	0	1.60000	0	1	0	1	1	1	0	1	1.03125
0	0	0	0	0	0	1	1	1.59375	0	1	0	1	1	1	1	0	1.02500
0	0	0	0	0	1	0	0	1.58750	0	1	0	1	1	1	1	1	1.01875
0	0	0	0	0	1	0	1	1.58125	0	1	1	0	0	0	0	0	1.01250
0	0	0	0	0	1	1	0	1.57500	0	1	1	0	0	0	0	1	1.00625
0	0	0	0	0	1	1	1	1.56875	0	1	1	0	0	0	1	0	1.00000
0	0	0	0	1	0	0	0	1.56250	0	1	1	0	0	0	1	1	0.99375
0	0	0	0	1	0	0	1	1.55625	0	1	1	0	0	1	0	0	0.98750
0	0	0	0	1	0	1	0	1.55000	0	1	1	0	0	1	0	1	0.98125
0	0	0	0	1	0	1	1	1.54375	0	1	1	0	0	1	1	0	0.97500
0	0	0	0	1	1	0	0	1.53750	0	1	1	0	0	1	1	1	0.96875
0	0	0	0	1	1	0	1	1.53125	0	1	1	0	1	0	0	0	0.96250
0	0	0	0	1	1	1	0	1.52500	0	1	1	0	1	0	0	1	0.95626
0	0	0	0	1	1	1	1	1.51875	0	1	1	0	1	0	1	0	0.95000
0	0	0	1	0	0	0	0	1.51250	0	1	1	0	1	0	1	1	0.94375
0	0	0	1	0	0	0	1	1.50625	0	1	1	0	1	1	0	0	0.93750
0	0	0	1	0	0	1	0	1.50000	0	1	1	0	1	1	0	1	0.93125
0	0	0	1	0	0	1	1	1.49375	0	1	1	0	1	1	1	0	0.92500
0	0	0	1	0	1	0	0	1.48750	0	1	1	0	1	1	1	1	0.91875
0	0	0	1	0	1	0	1	1.48125	0	1	1	1	0	0	0	0	0.91250
0	0	0	1	0	1	1	0	1.47500	0	1	1	1	0	0	0	1	0.90625
0	0	0	1	0	1	1	1	1.46875	0	1	1	1	0	0	1	0	0.90000
0	0	0	1	1	0	0	0	1.46250	0	1	1	1	0	0	1	1	0.89375
0	0	0	1	1	0	0	1	1.45625	0	1	1	1	0	1	0	0	0.88750
0	0	0	1	1	0	1	0	1.45000	0	1	1	1	0	1	0	1	0.88125
0	0	0	1	1	0	1	1	1.44375	0	1	1	1	0	1	1	0	0.87500
0	0	0	1	1	1	0	0	1.43750	0	1	1	1	0	1	1	1	0.86875
0	0	0	1	1	1	0	1	1.43125	0	1	1	1	1	0	0	0	0.86250
0	0	0	1	1	1	1	0	1.42500	0	1	1	1	1	0	0	1	0.85625
0	0	0	1	1	1	1	1	1.41875	0	1	1	1	1	0	1	0	0.85000
0	0	1	0	0	0	0	0	1.41250	0	1	1	1	1	0	1	1	0.84374
0	0	1	0	0	0	0	1	1.40625	0	1	1	1	1	1	0	0	0.83750
0	0	1	0	0	0	1	0	1.40000	0	1	1	1	1	1	0	1	0.83125
0	0	1	0	0	0	1	1	1.39375	0	1	1	1	1	1	1	0	0.82500
0	0	1	0	0	1	0	0	1.38750	0	1	1	1	1	1	1	1	0.81875
0	0	1	0	0	1	0	1	1.38125	1	0	0	0	0	0	0	0	0.81250
0	0	1	0	0	1	1	0	1.37500	1	0	0	0	0	0	0	1	0.80625
0	0	1	0	0	1	1	1	1.36875	1	0	0	0	0	0	1	0	0.80000
0	0	1	0	1	0	0	0	1.36250	1	0	0	0	0	0	1	1	0.79375
0	0	1	0	1	0	0	1	1.35625	1	0	0	0	0	1	0	0	0.78750
0	0	1	0	1	0	1	0	1.35000	1	0	0	0	0	1	0	1	0.78125
0	0	1	0	1	0	1	1	1.34375	1	0	0	0	0	1	1	0	0.77500
0	0	1	0	1	1	0	0	1.33750	1	0	0	0	0	1	1	1	0.76875
0	0	1	0	1	1	0	1	1.33125	1	0	0	0	1	0	0	0	0.76250
0	0	1	0	1	1	1	0	1.32500	1	0	0	0	1	0	0	1	0.75625
0	0	1	0	1	1	1	1	1.31875	1	0	0	0	1	0	1	0	0.75000





Table 2-1. Voltage Identification Definition (Sheet 2 of 2)

VID 7	VID 6	VID 5	VID 4	VID 3	VID 2	VID 1	VID 0	V <sub>CC_MAX</sub>	VID 7	VID 6	VID 5	VID 4	VID 3	VID 2	VID 1	VID 0	V <sub>CC_MAX</sub>
0	0	1	1	0	0	0	0	1.31250	1	0	0	0	1	0	1	1	0.74375
0	0	1	1	0	0	0	1	1.30625	1	0	0	0	1	1	0	0	0.73750
0	0	1	1	0	0	1	0	1.30000	1	0	0	0	1	1	0	1	0.73125
0	0	1	1	0	0	1	1	1.29375	1	0	0	0	1	1	1	0	0.72500
0	0	1	1	0	1	0	0	1.28750	1	0	0	0	1	1	1	1	0.71875
0	0	1	1	0	1	0	1	1.28125	1	0	0	1	0	0	0	0	0.71250
0	0	1	1	0	1	1	0	1.27500	1	0	0	1	0	0	0	1	0.70625
0	0	1	1	0	1	1	1	1.26875	1	0	0	1	0	0	1	0	0.70000
0	0	1	1	1	0	0	0	1.26250	1	0	0	1	0	0	1	1	0.69375
0	0	1	1	1	0	0	1	1.25625	1	0	0	1	0	1	0	0	0.68750
0	0	1	1	1	0	1	0	1.25000	1	0	0	1	0	1	0	1	0.68125
0	0	1	1	1	0	1	1	1.24375	1	0	0	1	0	1	1	0	0.67500
0	0	1	1	1	1	0	0	1.23750	1	0	0	1	0	1	1	1	0.66875
0	0	1	1	1	1	0	1	1.23125	1	0	0	1	1	0	0	0	0.66250
0	0	1	1	1	1	1	0	1.22500	1	0	0	1	1	0	0	1	0.65625
0	0	1	1	1	1	1	1	1.21875	1	0	0	1	1	0	1	0	0.65000
0	1	0	0	0	0	0	0	1.21250	1	0	0	1	1	0	1	1	0.64375
0	1	0	0	0	0	0	1	1.20625	1	0	0	1	1	1	0	0	0.63750
0	1	0	0	0	0	1	0	1.20000	1	0	0	1	1	1	0	1	0.63125
0	1	0	0	0	0	1	1	1.19375	1	0	0	1	1	1	1	0	0.62500
0	1	0	0	0	1	0	0	1.18750	1	0	0	1	1	1	1	1	0.61875
0	1	0	0	0	1	0	1	1.18125	1	0	1	0	0	0	0	0	0.61250
0	1	0	0	0	1	1	0	1.17500	1	0	1	0	0	0	0	1	0.60625
0	1	0	0	0	1	1	1	1.16875	1	0	1	0	0	0	1	0	0.60000
0	1	0	0	1	0	0	0	1.16250	1	0	1	0	0	0	1	1	0.59375
0	1	0	0	1	0	0	1	1.15625	1	0	1	0	0	1	0	0	0.58750
0	1	0	0	1	0	1	0	1.15000	1	0	1	0	0	1	0	1	0.58125
0	1	0	0	1	0	1	1	1.14375	1	0	1	0	0	1	1	0	0.57500
0	1	0	0	1	1	0	0	1.13750	1	0	1	0	0	1	1	1	0.56875
0	1	0	0	1	1	0	1	1.13125	1	0	1	0	1	0	0	0	0.56250
0	1	0	0	1	1	1	0	1.12500	1	0	1	0	1	0	0	1	0.55625
0	1	0	0	1	1	1	1	1.11875	1	0	1	0	1	0	1	0	0.55000
0	1	0	1	0	0	0	0	1.11250	1	0	1	0	1	0	1	1	0.54375
0	1	0	1	0	0	0	1	1.10625	1	0	1	0	1	1	0	0	0.53750
0	1	0	1	0	0	1	0	1.10000	1	0	1	0	1	1	0	1	0.53125
0	1	0	1	0	0	1	1	1.09375	1	0	1	0	1	1	1	0	0.52500
0	1	0	1	0	1	0	0	1.08750	1	0	1	0	1	1	1	1	0.51875
0	1	0	1	0	1	0	1	1.08125	1	0	1	1	0	0	0	0	0.51250
0	1	0	1	0	1	1	0	1.07500	1	0	1	1	0	0	0	1	0.50625
0	1	0	1	0	1	1	1	1.06875	1	0	1	1	0	0	1	0	0.50000
0	1	0	1	1	0	0	0	1.06250	1	1	1	1	1	1	1	0	OFF
0	1	0	1	1	0	0	1	1.05625	1	1	1	1	1	1	1	1	OFF
0	1	0	1	1	0	1	0	1.05000									

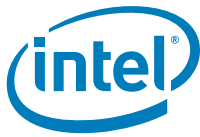

Table 2-2. Market Segment Selection Truth Table for MS\_ID[2:0]

MSID2	MSID1	MSID0	Description <sup>1</sup>
0	0	0	Reserved
0	0	1	Reserved
0	1	0	Reserved
0	1	1	Reserved
1	0	0	Reserved
1	0	1	Reserved
1	1	0	Intel® Core™ i7-900 desktop processor Extreme Edition series and Intel® Core™ i7-900 desktop processor series on 32-nm process
1	1	1	Reserved

**Notes:**

1. The MSID[2:0] signals are provided to indicate the market segment for the processor and may be used for future processor compatibility or for keying.

## 2.6 Reserved or Unused Signals

All Reserved (RSVD) signals must remain unconnected. Connection of these signals to  $V_{CC}$ ,  $V_{TTA}$ ,  $V_{TTD}$ ,  $V_{DDQ}$ ,  $V_{CCPLL}$ ,  $V_{SS}$ , or to any other signal (including each other) can result in component malfunction or incompatibility with future processors. See [Chapter 4](#) for a land listing of the processor and the location of all Reserved signals.

For reliable operation, always connect unused inputs or bi-directional signals to an appropriate signal level, except for unused integrated memory controller inputs, outputs, and bi-directional pins that may be left floating. Unused active high inputs should be connected through a resistor to ground ( $V_{SS}$ ). Unused outputs may be left unconnected; however, this may interfere with some Test Access Port (TAP) functions, complicate debug probing, and prevent boundary scan testing. A resistor must be used when tying bi-directional signals to power or ground. When tying any signal to power or ground, a resistor will also allow for system testability.



## 2.7 Signal Groups

Signals are grouped by buffer type and similar characteristics as listed in Table 2-3. The buffer type indicates which signaling technology and specifications apply to the signals. All the differential signals, and selected DDR3 and Control Sideband signals have On-Die Termination (ODT) resistors. There are some signals that do not have ODT and need to be terminated on the board. The signals that have ODT are listed in Table 2-4.

Table 2-3. Signal Groups (Sheet 1 of 2)

Signal Group	Type	Signals <sup>1,2</sup>
<b>System Reference Clock</b>		
Differential	Clock Input	BCLK_DP, BCLK_DN
<b>Intel QPI Signal Groups</b>		
Differential	Intel QPI Input	QPI_DRX_D[N/P][19:0], QPI_CLKRX_DP, QPI_CLKRX_DN
Differential	Intel QPI Output	QPI_DTX_D[N/P][19:0], QPI_CLKTX_DP, QPI_CLKTX_DN
<b>DDR3 Reference Clocks</b>		
Differential	DDR3 Output	DDR{0/1/2}_CLK[D/P][3:0]
<b>DDR3 Command Signals</b>		
Single ended	CMOS Output	DDR{0/1/2}_RAS#, DDR{0/1/2}_CAS#, DDR{0/1/2}_WE#, DDR{0/1/2}_MA[15:0], DDR{0/1/2}_BA[2:0]
Single ended	Asynchronous Output	DDR{0/1/2}_RESET#
<b>DDR3 Control Signals</b>		
Single ended	CMOS Output	DDR{0/1/2}_CS#[5:4], DDR{0/1/2}_CS#[1:0], DDR{0/1/2}_ODT[3:0], DDR{0/1/2}_CKE[3:0]
<b>DDR3 Data Signals</b>		
Single ended	CMOS Bi-directional	DDR{0/1/2}_DQ[63:0]
Differential	CMOS Bi-directional	DDR{0/1/2}_DQS_[N/P][7:0]
<b>TAP</b>		
Single ended	TAP Input	TCK, TDI, TMS, TRST#
Single ended	GTL Output	TDO
<b>Control Sideband</b>		
Single ended	Asynchronous GTL Output	PRDY#
Single ended	Asynchronous GTL Input	PREQ#
Single ended	GTL Bi-directional	CAT_ERR#, BPM#[7:0]
Single Ended	Asynchronous Bi-directional	PECI
Single Ended	Analog Input	COMPO, QPI_CMP[0], DDR_COMP[2:0]
Single ended	Asynchronous GTL Bi-directional	PROCHOT#
Single ended	Asynchronous GTL Output	THERMTRIP#
Single ended	CMOS Input/Output	VID[7:6] VID[5:3]/CSC[2:0] VID[2:0]/MSID[2:0] VTT_VID[4:2]

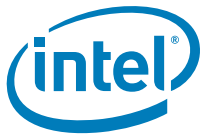

Table 2-3. Signal Groups (Sheet 2 of 2)

Signal Group	Type	Signals <sup>1,2</sup>
Single ended	CMOS Output	VTT_VID[4:2]
Single ended	Analog Input	ISENSE
<b>Reset Signal</b>		
Single ended	Reset Input	RESET#
<b>PWRGOOD Signals</b>		
Single ended	Asynchronous Input	VCCPWRGOOD, VTPPWRGOOD, VDDPWRGOOD
<b>Power/Other</b>		
	Power	VCC, VTTA, VTTD, VCCPLL, VDDQ
	Asynchronous CMOS Output	PSI#
	Sense Points	VCC_SENSE, VSS_SENSE
	Other	SKTOCC#, DBR#

**Notes:**

1. Refer to [Chapter 5](#) for signal descriptions.
2. DDR{0/1/2} refers to DDR3 Channel 0, DDR3 Channel 1, and DDR3 Channel 2.

Table 2-4. Signals with ODT

<ul style="list-style-type: none"> <li>• QPI_DRX_DP[19:0], QPI_DRX_DN[19:0], QPI_DTX_DP[19:0], QPI_DTX_DN[19:0], QPI_CLKRX_D[N/P], QPI_CLKTX_D[N/P]</li> <li>• DDR{0/1/2}_DQ[63:0], DDR{0/1/2}_DQS_[N/P][7:0], DDR{0/1/2}_PAR_ERR#[0:2], VDDPWRGOOD</li> <li>• BCLK_ITP_D[N/P]</li> <li>• PECl</li> <li>• BPM#[7:0], PREQ#, TRST#, VCCPWRGOOD, VTPPWRGOOD</li> </ul>
--

**Note:**

1. Unless otherwise specified, signals have ODT in the package with 50 Ω pulldown to V<sub>SS</sub>.
2. PREQ#, BPM[7:0], TDI, TMS and BCLK\_ITP\_D[N/P] have ODT in package with 35 Ω pullup to V<sub>TT</sub>.
3. VCCPWRGOOD, VDDPWRGOOD, and VTPPWRGOOD have ODT in package with a 10 kΩ to 20 kΩ pulldown to V<sub>SS</sub>.
4. TRST# has ODT in package with a 1 kΩ to 5 kΩ pullup to V<sub>TT</sub>.
5. All DDR signals are terminated to VDDQ/2
6. DDR{0/1/2} refers to DDR3 Channel 0, DDR3 Channel 1, and DDR3 Channel 2.
7. While TMS and TDI do not have On-Die Termination, these signals are weakly pulled up using a 1–5 kΩ resistor to V<sub>TT</sub>
8. While TCK does not have On-Die Termination, this signal is weakly pulled down using a 1–5 kΩ resistor to V<sub>SS</sub>.

All Control Sideband Asynchronous signals are required to be asserted/de-asserted for at least eight BCLKs for the processor to recognize the proper signal state. See [Section 2.11](#) for the DC specifications. See [Chapter 6](#) for additional timing requirements for entering and leaving the low power states.

## 2.8 Test Access Port (TAP) Connection

Due to the voltage levels supported by other components in the Test Access Port (TAP) logic, it is recommended that the processor be first in the TAP chain and followed by any other components within the system. A translation buffer should be used to connect to the rest of the chain unless one of the other components is capable of accepting an input of the appropriate voltage. Two copies of each signal may be required with each driving a different voltage level.

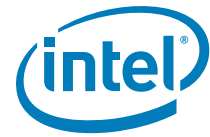

## 2.9 Platform Environmental Control Interface (PECI) DC Specifications

PECI is an Intel proprietary interface that provides a communication channel between Intel processors and chipset components to external thermal monitoring devices. The processor contains a Digital Thermal Sensor (DTS) that reports a relative die temperature as an offset from Thermal Control Circuit (TCC) activation temperature. Temperature sensors located throughout the die are implemented as analog-to-digital converters calibrated at the factory. PECI provides an interface for external devices to read the DTS temperature for thermal management and fan speed control. More detailed information may be found in the *Platform Environment Control Interface (PECI) Specification*.

### 2.9.1 DC Characteristics

The PECI interface operates at a nominal voltage set by  $V_{TTD}$ . The set of DC electrical specifications shown in [Table 2-5](#) is used with devices normally operating from a  $V_{TTD}$  interface supply.  $V_{TTD}$  nominal levels will vary between processor families. All PECI devices will operate at the  $V_{TTD}$  level determined by the processor installed in the system. For specific nominal  $V_{TTD}$  levels, refer to [Table 2-7](#).

**Table 2-5. PECI DC Electrical Limits**

Symbol	Definition and Conditions	Min	Max	Units	Notes <sup>1</sup>
$V_{in}$	Input Voltage Range	-0.150	$V_{TTD}$	V	
$V_{hysteresis}$	Hysteresis	$0.1 * V_{TTD}$	N/A	V	
$V_n$	Negative-edge threshold voltage	$0.275 * V_{TTD}$	$0.500 * V_{TTD}$	V	
$V_p$	Positive-edge threshold voltage	$0.550 * V_{TTD}$	$0.725 * V_{TTD}$	V	
$I_{source}$	High level output source ( $V_{OH} = 0.75 * V_{TTD}$ )	-6.0	N/A	mA	
$I_{sink}$	Low level output sink ( $V_{OL} = 0.25 * V_{TTD}$ )	0.5	1.0	mA	
$I_{leak+}$	High impedance state leakage to $V_{TTD}$ ( $V_{leak} = V_{OL}$ )	N/A	100	$\mu$ A	2
$I_{leak-}$	High impedance leakage to GND ( $V_{leak} = V_{OH}$ )	N/A	100	$\mu$ A	2
$C_{bus}$	Bus capacitance per node	N/A	10	pF	
$V_{noise}$	Signal noise immunity above 300 MHz	$0.1 * V_{TTD}$	N/A	$V_{p-p}$	

**Note:**

- $V_{TTD}$  supplies the PECI interface. PECI behavior does not affect  $V_{TTD}$  min/max specifications.
- The leakage specification applies to powered devices on the PECI bus.

## 2.9.2 Input Device Hysteresis

The input buffers in both client and host models must use a Schmitt-triggered input design for improved noise immunity. Use [Figure 2-2](#) as a guide for input buffer design.

Figure 2-2. Input Device Hysteresis

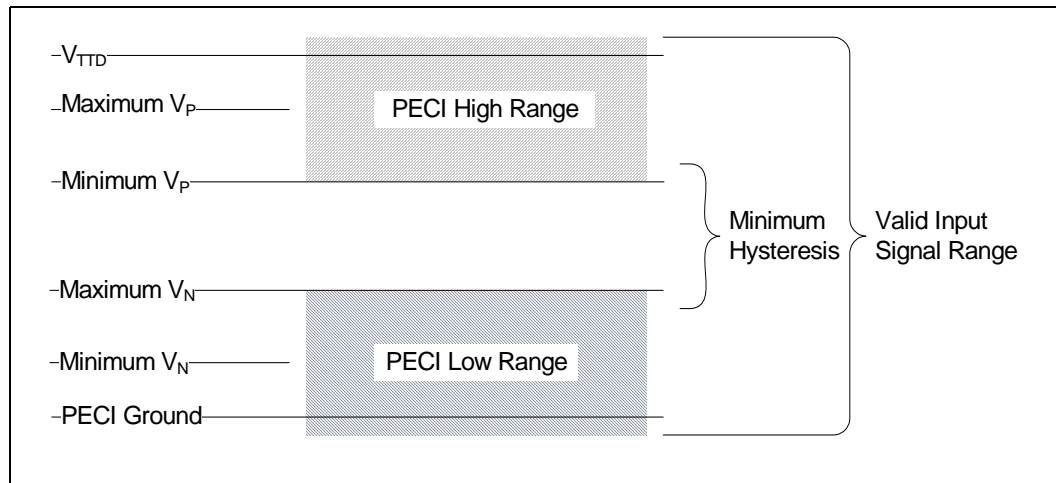

## 2.10 Absolute Maximum and Minimum Ratings

[Table 2-6](#) specifies absolute maximum and minimum ratings, which lie outside the functional limits of the processor. Only within specified operation limits can functionality and long-term reliability be expected.

At conditions outside functional operation condition limits, but within absolute maximum and minimum ratings, neither functionality nor long-term reliability can be expected. If a device is returned to conditions within functional operation limits after having been subjected to conditions outside these limits, but within the absolute maximum and minimum ratings, the device may be functional, but with its lifetime degraded depending on exposure to conditions exceeding the functional operation condition limits.

At conditions exceeding absolute maximum and minimum ratings, neither functionality nor long-term reliability can be expected. Moreover, if a device is subjected to these conditions for any length of time then, when returned to conditions within the functional operating condition limits, it will either not function or its reliability will be severely degraded.

Although the processor contains protective circuitry to resist damage from Electro-Static Discharge (ESD), precautions should always be taken to avoid high static voltages or electric fields.

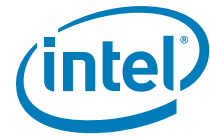
**Table 2-6. Processor Absolute Minimum and Maximum Ratings**

Symbol	Parameter	Min	Max	Unit	Notes <sup>1, 2</sup>
$V_{CC}$	Processor Core voltage with respect to $V_{SS}$	-0.3	1.4	V	
$V_{TTA}$	Voltage for the analog portion of the integrated memory controller, QPI link and Shared Cache with respect to $V_{SS}$	-0.3	1.4	V	3
$V_{TTD}$	Voltage for the digital portion of the integrated memory controller, QPI link and Shared Cache with respect to $V_{SS}$	-0.3	1.4	V	3
$V_{DDQ}$	Processor I/O supply voltage for DDR3 with respect to $V_{SS}$	-0.3	1.8	V	
$V_{CCPLL}$	Processor PLL voltage with respect to $V_{SS}$	-0.3	2.0	V	
$T_{CASE}$	Processor case temperature	See Chapter 6	See Chapter 6	°C	
$T_{STORAGE}$	Storage temperature	See Chapter 6	See Chapter 6	°C	

**Notes:**

1. For functional operation, all processor electrical, signal quality, mechanical and thermal specifications must be satisfied.
2. Excessive overshoot or undershoot on any signal will likely result in permanent damage to the processor.
3.  $V_{TTA}$  and  $V_{TTD}$  should be derived from the same VR.

## 2.11 Processor DC Specifications

The processor DC specifications in this section are defined at the processor pads, unless noted otherwise. See Chapter 4 for the processor land listings and Chapter 5 for signal definitions. Voltage and current specifications are detailed in Table 2-7. For platform planning, refer to Table 2-8 that provides  $V_{CC}$  static and transient tolerances. This same information is presented graphically in Figure 2-3.

The DC specifications for the DDR3 signals are listed in Table 2-11. Control Sideband and Test Access Port (TAP) are listed in Table 2-12 through Table 2-15.

Table 2-7 through Table 2-15 list the DC specifications for the processor and are valid only while meeting specifications for case temperature ( $T_{CASE}$  as specified in Chapter 6, “Thermal Specifications”), clock frequency, and input voltages. Care should be taken to read all notes associated with each parameter.



## 2.11.1 DC Voltage and Current Specification

Table 2-7. Voltage and Current Specifications

Symbol	Parameter		Min	Typ	Max	Unit	Notes <sup>1</sup>
VID	VID range		0.8		1.375	V	2
V <sub>CC</sub>	Processor Number i7-990X i7-980X i7-980 i7-970	V <sub>CC</sub> for processor core  3.46 GHz 3.33 GHz 3.33 GHz 3.20 GHz	See Table 2-8 and Figure 2-3			V	3,4
V <sub>TTA</sub>	Voltage for the analog portion of the integrated memory controller, QPI link and Shared Cache		See Table 2-10 and Figure 2-4			V	5
V <sub>TTD</sub>	Voltage for the digital portion of the integrated memory controller, QPI link and Shared Cache		See Table 2-9 and Figure 2-4			V	5
V <sub>DDQ</sub>	Processor I/O supply voltage for DDR3		1.425	1.5	1.575	V	
V <sub>CCPLL</sub>	PLL supply voltage (DC + AC specification)		1.71	1.8	1.89	V	
I <sub>CC</sub>	Processor Number i7-990X i7-980X i7-980 i7-970	I <sub>CC</sub> for processor  3.46 GHz 3.33 GHz 3.33 GHz 3.20 GHz	—	—	145 145 145 145	A	6
I <sub>TTA</sub>	Current for the analog portion of the integrated memory controller, QPI link and Shared Cache		—	—	5	A	
I <sub>TTD</sub>	Current for the digital portion of the integrated memory controller, QPI link and Shared Cache		—	—	23	A	
I <sub>DDQ</sub>	Processor I/O supply current for DDR3		—	—	6	A	
I <sub>DDQ</sub> S3	Processor I/O supply current for DDR3 while in S3		—	—	1	A	7
I <sub>CC_VCCPLL</sub>	PLL supply current (DC + AC specification)		—	—	1.1	A	

**Notes:**

1. Unless otherwise noted, all specifications in this table are based on estimates and simulations or empirical data. These specifications will be updated with characterized data from silicon measurements at a later date.
2. Each processor is programmed with a maximum valid voltage identification value (VID), which is set at manufacturing and can not be altered. Individual maximum VID values are calibrated during manufacturing such that two processors at the same frequency may have different settings within the VID range. Note that this differs from the VID employed by the processor during a power management event (Adaptive Thermal Monitor, Enhanced Intel SpeedStep<sup>®</sup> Technology, or Low Power States).
3. The voltage specification requirements are measured across V<sub>CC\_SENSE</sub> and V<sub>VSS\_SENSE</sub> lands at the socket with a 100 MHz bandwidth oscilloscope, 1.5 pF maximum probe capacitance, and 1 MΩ minimum impedance. The maximum length of ground wire on the probe should be less than 5 mm. Ensure external noise from the system is not coupled into the oscilloscope probe.
4. Refer to Table 2-8 and Figure 2-3 for the minimum, typical, and maximum V<sub>CC</sub> allowed for a given current. The processor should not be subjected to any V<sub>CC</sub> and I<sub>CC</sub> combination wherein V<sub>CC</sub> exceeds V<sub>CC\_MAX</sub> for a given current.
5. See Table 2-9 for details on V<sub>TT</sub> Voltage Identification. See Table 2-10 and Figure 2-4 for details on the V<sub>TT</sub> Loadline.
6. I<sub>CC\_MAX</sub> specification is based on the V<sub>CC\_MAX</sub> loadline. Refer to Figure 2-3 for details.
7. This specification is based on a processor temperature, as reported by the DTS, of less than or equal to T<sub>CONTROL-25</sub>.



Table 2-8.  $V_{CC}$  Static and Transient Tolerance

$I_{CC}$ (A)	$V_{CC\_Max}$ (V)	$V_{CC\_Typ}$ (V)	$V_{CC\_Min}$ (V)	Notes
0	VID – 0.000	VID – 0.019	VID – 0.038	1, 2, 3
5	VID – 0.004	VID – 0.023	VID – 0.042	1, 2, 3
10	VID – 0.008	VID – 0.027	VID – 0.046	1, 2, 3
15	VID – 0.012	VID – 0.031	VID – 0.050	1, 2, 3
20	VID – 0.016	VID – 0.035	VID – 0.054	1, 2, 3
25	VID – 0.020	VID – 0.039	VID – 0.058	1, 2, 3
30	VID – 0.024	VID – 0.043	VID – 0.062	1, 2, 3
35	VID – 0.028	VID – 0.047	VID – 0.066	1, 2, 3
40	VID – 0.032	VID – 0.051	VID – 0.070	1, 2, 3
45	VID – 0.036	VID – 0.055	VID – 0.074	1, 2, 3
50	VID – 0.040	VID – 0.059	VID – 0.078	1, 2, 3
55	VID – 0.044	VID – 0.063	VID – 0.082	1, 2, 3
60	VID – 0.048	VID – 0.067	VID – 0.086	1, 2, 3
65	VID – 0.052	VID – 0.071	VID – 0.090	1, 2, 3
70	VID – 0.056	VID – 0.075	VID – 0.094	1, 2, 3
75	VID – 0.060	VID – 0.079	VID – 0.098	1, 2, 3
78	VID – 0.062	VID – 0.081	VID – 0.100	1, 2, 3
85	VID – 0.068	VID – 0.087	VID – 0.106	1, 2, 3
90	VID – 0.072	VID – 0.091	VID – 0.110	1, 2, 3
95	VID – 0.076	VID – 0.095	VID – 0.114	1, 2, 3
100	VID – 0.080	VID – 0.099	VID – 0.118	1, 2, 3
105	VID – 0.084	VID – 0.103	VID – 0.122	1, 2, 3
110	VID – 0.088	VID – 0.107	VID – 0.126	1, 2, 3
115	VID – 0.092	VID – 0.111	VID – 0.130	1, 2, 3
120	VID – 0.096	VID – 0.115	VID – 0.134	1, 2, 3
125	VID – 0.100	VID – 0.119	VID – 0.138	1, 2, 3
130	VID – 0.104	VID – 0.123	VID – 0.142	1, 2, 3
135	VID – 0.108	VID – 0.127	VID – 0.146	1, 2, 3
140	VID – 0.112	VID – 0.131	VID – 0.150	1, 2, 3

**Notes:**

1. The  $V_{CC\_MIN}$  and  $V_{CC\_MAX}$  loadlines represent static and transient limits. See Section 2.11.2 for  $V_{CC}$  overshoot specifications.
2. This table is intended to aid in reading discrete points on Figure 2-3.
3. The loadlines specify voltage limits at the die measured at the  $V_{CC\_SENSE}$  and  $V_{SS\_SENSE}$  lands. Voltage regulation feedback for voltage regulator circuits must also be taken from processor  $V_{CC\_SENSE}$  and  $V_{SS\_SENSE}$  lands. Refer to the *Voltage Regulator Down (VRD) 11.1 Design Guidelines* for socket load line guidelines and VR implementation.

Figure 2-3.  $V_{CC}$  Static and Transient Tolerance Load Lines

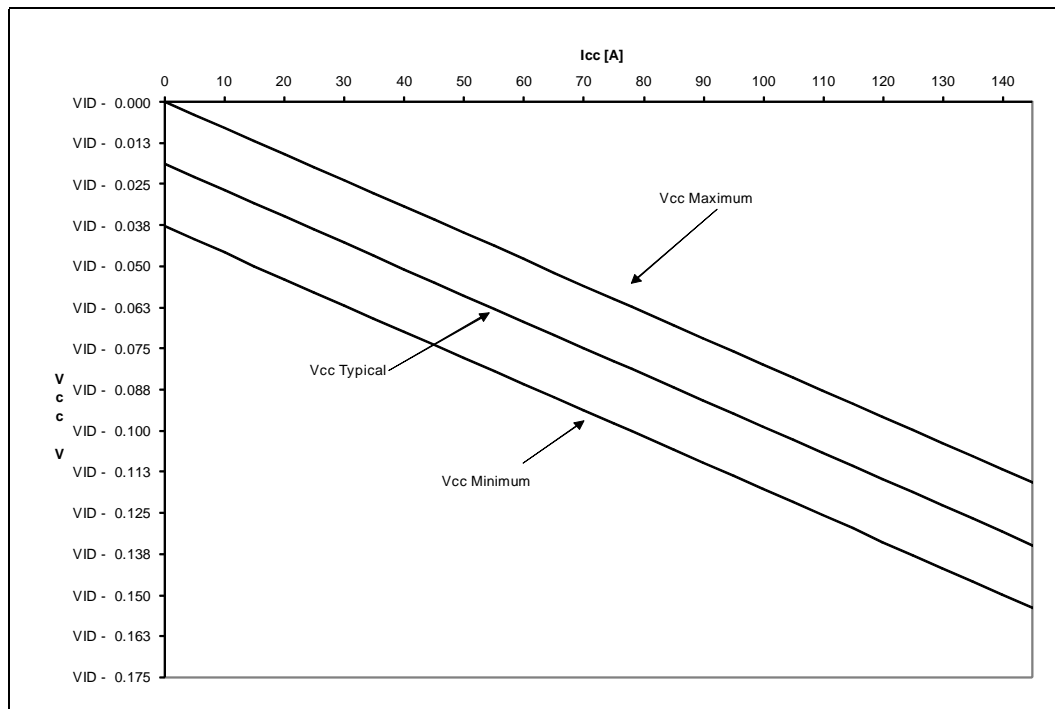
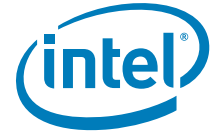

Table 2-9.  $V_{TT}$  Voltage Identification (VID) Definition

VTT VR - VID Input								$V_{TT\_Typ}$
VID7	VID6	VID5	VID4	VID3	VID2	VID1	VID0	
0	1	0	0	0	0	1	0	1.220 V
0	1	0	0	0	1	1	0	1.195 V
0	1	0	0	1	0	1	0	1.170 V
0	1	0	0	1	1	1	0	1.145 V
0	1	0	1	0	0	1	0	1.120 V
0	1	0	1	0	1	1	0	1.095 V
0	1	0	1	1	0	1	0	1.070 V
0	1	0	1	1	1	1	0	1.045 V

**Notes:**

1. The associated voltage with the VTT VID codes listed in this table do not match the *Voltage Regulator-Down (VRD) 11.1 Design Guidelines*, they include a +20 mV offset.
2. This is a typical voltage. See Table 2-10 for VTT\_Max and VTT\_Min voltage.

Table 2-10.  $V_{TT}$  Static and Transient Tolerance <sup>1</sup>

$I_{TT}$ (A)	$V_{TT\_Max}$ (V)	$V_{TT\_Typ}$ (V)	$V_{TT\_Min}$ (V)	Notes
0	VID + 0.0315	VID – 0.0000	VID – 0.0315	
1	VID + 0.0255	VID – 0.0060	VID – 0.0375	
2	VID + 0.0195	VID – 0.0120	VID – 0.0435	
3	VID + 0.0135	VID – 0.0180	VID – 0.0495	
4	VID + 0.0075	VID – 0.0240	VID – 0.0555	
5	VID + 0.0015	VID – 0.0300	VID – 0.0615	
6	VID – 0.0045	VID – 0.0360	VID – 0.0675	
7	VID – 0.0105	VID – 0.0420	VID – 0.0735	
8	VID – 0.0165	VID – 0.0480	VID – 0.0795	
9	VID – 0.0225	VID – 0.0540	VID – 0.0855	
10	VID – 0.0285	VID – 0.0600	VID – 0.0915	
11	VID – 0.0345	VID – 0.0660	VID – 0.0975	
12	VID – 0.0405	VID – 0.0720	VID – 0.1035	
13	VID – 0.0465	VID – 0.0780	VID – 0.1095	
14	VID – 0.0525	VID – 0.0840	VID – 0.1155	
15	VID – 0.0585	VID – 0.0900	VID – 0.1215	
16	VID – 0.0645	VID – 0.0960	VID – 0.1275	
17	VID – 0.0705	VID – 0.1020	VID – 0.1335	
18	VID – 0.0765	VID – 0.1080	VID – 0.1395	
19	VID – 0.0825	VID – 0.1140	VID – 0.1455	
20	VID – 0.0885	VID – 0.1200	VID – 0.1515	
21	VID – 0.0945	VID – 0.1260	VID – 0.1575	
22	VID – 0.1005	VID – 0.1320	VID – 0.1635	
23	VID – 0.1065	VID – 0.1380	VID – 0.1695	
24	VID – 0.1125	VID – 0.1440	VID – 0.1755	
25	VID – 0.1185	VID – 0.1500	VID – 0.1815	
26	VID – 0.1245	VID – 0.1560	VID – 0.1875	
27	VID – 0.1305	VID – 0.1620	VID – 0.1935	
28	VID – 0.1365	VID – 0.1680	VID – 0.1995	

**Notes:**

1. The  $I_{TT}$  listed in this table is a sum of  $I_{TTA}$  and  $I_{TTD}$ .
2. The loadlines specify voltage limits at the die measured at the VTT\_SENSE and VSS\_SENSE\_VTT lands. Voltage regulation feedback for voltage regulator circuits must also be taken from the processor VTT\_SENSE and VSS\_SENSE\_VTT lands.

Figure 2-4.  $V_{TT}$  Static and Transient Tolerance Load Line

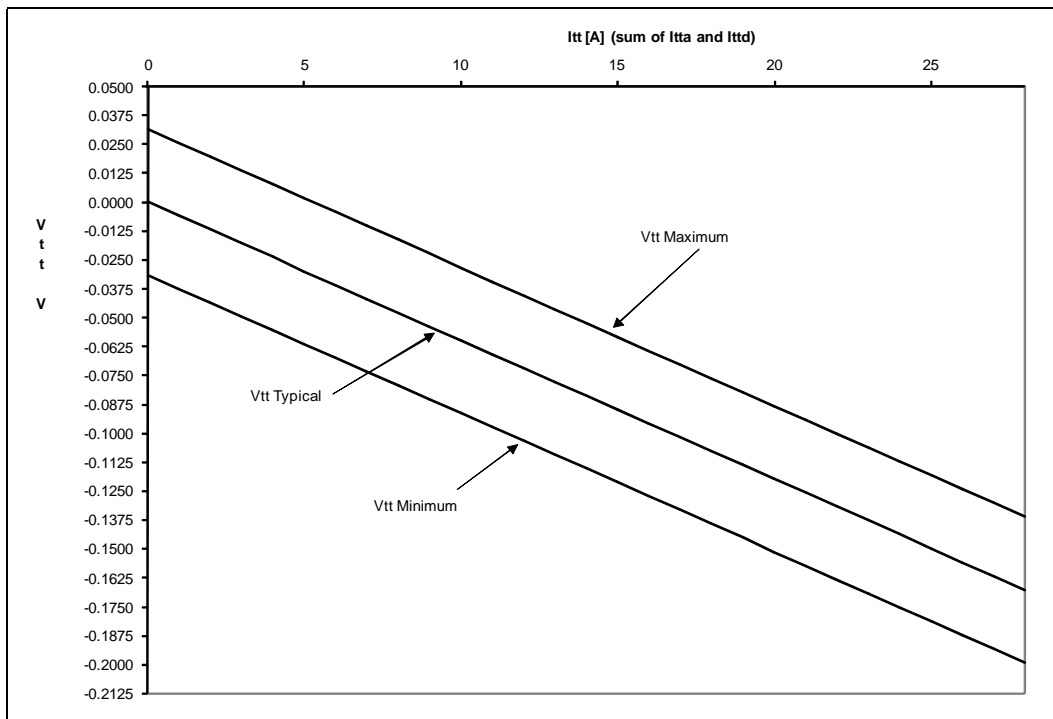
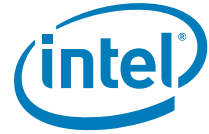

Table 2-11. DDR3 Signal Group DC Specifications

Symbol	Parameter	Min	Typ	Max	Units	Notes <sup>1</sup>
$V_{IL}$	Input Low Voltage	—	—	$0.43 * V_{DDQ}$	V	2,4
$V_{IH}$	Input High Voltage	$0.57 * V_{DDQ}$	—	—	V	3
$V_{OL}$	Output Low Voltage	—	$(V_{DDQ} / 2) * (R_{ON} / (R_{ON} + R_{VTT\_TERM}))$	—	V	
$V_{OH}$	Output High Voltage	—	$V_{DDQ} - ((V_{DDQ} / 2) * (R_{ON} / (R_{ON} + R_{VTT\_TERM})))$	—	V	4
$R_{ON}$	DDR3 Clock Buffer On Resistance	21	—	31	$\Omega$	7
$R_{ON}$	DDR3 Command Buffer On Resistance	16	—	24	$\Omega$	
$R_{ON}$	DDR3 Reset Buffer On Resistance	25	—	75	$\Omega$	
$R_{ON}$	DDR3 Control Buffer On Resistance	21	—	31	$\Omega$	
$R_{ON}$	DDR3 Data Buffer On Resistance	21	—	33	$\Omega$	
$I_{LI}$	Input Leakage Current	N/A	N/A	$\pm 1$	mA	
DDR_COMP0	COMP Resistance	99	100	101	$\Omega$	5
DDR_COMP1	COMP Resistance	24.65	24.9	25.15	$\Omega$	5
DDR_COMP2	COMP Resistance	128.7	130	131.30	$\Omega$	5

**Notes:**

1. Unless otherwise noted, all specifications in this table apply to all processor frequencies.
2.  $V_{IL}$  is defined as the maximum voltage level at a receiving agent that will be interpreted as a logical low value.



3.  $V_{IH}$  is defined as the minimum voltage level at a receiving agent that will be interpreted as a logical high value.
4.  $V_{IH}$  and  $V_{OH}$  may experience excursions above  $V_{DDQ}$ . However, input signal drivers must comply with the signal quality specifications.
5. COMP resistance must be provided on the system board with 1% resistors. DDR\_COMP[2:0] resistors are to  $V_{SS}$ .
6. This is the pull down driver resistance.

**Table 2-12. RESET# Signal DC Specifications**

Symbol	Parameter	Min	Typ	Max	Units	Notes <sup>1</sup>
$V_{IL}$	Input Low Voltage	—	—	$0.40 * V_{TTA}$	V	2
$V_{IH}$	Input High Voltage	$0.80 * V_{TTA}$	—	—	V	2,4
$I_{LI}$	Input Leakage Current	—	—	$\pm 200$	$\mu A$	3

**Notes:**

1. Unless otherwise noted, all specifications in this table apply to all processor frequencies.
2. The  $V_{TTA}$  referred to in these specifications refers to instantaneous  $V_{TTA}$ .
3. For  $V_{in}$  between 0 V and  $V_{TTA}$ . Measured when the driver is tristated.
4.  $V_{IH}$  and  $V_{OH}$  may experience excursions above  $V_{TT}$ .

**Table 2-13. TAP Signal Group DC Specifications**

Symbol	Parameter	Min	Typ	Max	Units	Notes <sup>1</sup>
$V_{IL}$	Input Low Voltage	—	—	$0.40 * V_{TTA}$	V	2
$V_{IH}$	Input High Voltage	$0.75 * V_{TTA}$	—	—	V	2,4
$V_{OL}$	Output Low Voltage	—	—	$\frac{V_{TTA} * R_{ON}}{(R_{ON} + R_{sys\_term})}$	V	2
$V_{OH}$	Output High Voltage	$V_{TTA}$	—	—	V	2,4
$R_{on}$	Buffer on Resistance	10	—	18	$\Omega$	
$I_{LI}$	Input Leakage Current	—	—	$\pm 200$	$\mu A$	3

**Notes:**

1. Unless otherwise noted, all specifications in this table apply to all processor frequencies.
2. The  $V_{TTA}$  referred to in these specifications refers to instantaneous  $V_{TTA}$ .
3. For  $V_{in}$  between 0 V and  $V_{TTA}$ . Measured when the driver is tristated.
4.  $V_{IH}$  and  $V_{OH}$  may experience excursions above  $V_{TT}$ .



**Table 2-14. PWRGOOD Signal Group DC Specifications**

Symbol	Parameter	Min	Typ	Max	Units	Notes <sup>1</sup>
V <sub>IL</sub>	Input Low Voltage for VCCPWRGOOD and VTTPWRGOOD Signals	—	—	0.25 * V <sub>TTA</sub>	V	2,5
V <sub>IL</sub>	Input Low Voltage for VDDPWRGOOD Signal	—	—	0.29	V	6
V <sub>IH</sub>	Input High Voltage for VCCPWRGOOD and VTTPWRGOOD Signals	0.75 * V <sub>TTA</sub>	—	—	V	2,5
V <sub>IH</sub>	Input High Voltage for VDDPWRGOOD Signal	0.87	—	—	V	6
R <sub>on</sub>	Buffer on Resistance	10	—	18	Ω	
I <sub>LI</sub>	Input Leakage Current	—	—	± 200	μA	3

**Notes:**

1. Unless otherwise noted, all specifications in this table apply to all processor frequencies.
2. The V<sub>TTA</sub> referred to in these specifications refers to instantaneous V<sub>TTA</sub>.
3. For Vin between 0 V and V<sub>TTA</sub>. Measured when the driver is tristated.
4. V<sub>IH</sub> and V<sub>OH</sub> may experience excursions above V<sub>TT</sub>.
5. This specification applies to VCCPWRGOOD and VTTPWRGOOD
6. This specification applies to VDDPWRGOOD

**Table 2-15. Control Sideband Signal Group DC Specifications**

Symbol	Parameter	Min	Typ	Max	Units	Notes <sup>1</sup>
V <sub>IL</sub>	Input Low Voltage	—	—	0.64 * V <sub>TTA</sub>	V	2
V <sub>IL</sub>	Input Low Voltage	—	—	0.61 * V <sub>TTA</sub>	V	2
V <sub>IH</sub>	Input High Voltage	0.76 * V <sub>TTA</sub>	—	—	V	2
V <sub>OL</sub>	Output Low Voltage	—	—	V <sub>TTA</sub> * R <sub>ON</sub> / (R <sub>ON</sub> + R <sub>sys_term</sub> )	V	2,4
V <sub>OH</sub>	Output High Voltage	V <sub>TTA</sub>	—	—	V	2,4
R <sub>on</sub>	Buffer on Resistance	10	—	18	Ω	
R <sub>on</sub>	Buffer on Resistance for VID[7:0]	—	100	—	Ω	
I <sub>LI</sub>	Input Leakage Current	—	—	± 200	μA	3
COMP0	COMP Resistance	49.4	49.9	50.40	Ω	5

**Notes:**

1. Unless otherwise noted, all specifications in this table apply to all processor frequencies.
2. The V<sub>TTA</sub> referred to in these specifications refers to instantaneous V<sub>TTA</sub>.
3. For Vin between 0 V and V<sub>TTA</sub>. Measured when the driver is tristated.
4. V<sub>IH</sub> and V<sub>OH</sub> may experience excursions above V<sub>TT</sub>.
5. COMP resistance must be provided on the system board with 1% resistors. COMP0 resistors are to V<sub>SS</sub>.

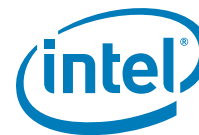

### 2.11.2 V<sub>CC</sub> Overshoot Specification

The processor can tolerate short transient overshoot events where V<sub>CC</sub> exceeds the VID voltage when transitioning from a high-to-low current load condition. This overshoot cannot exceed VID + V<sub>OS\_MAX</sub> (V<sub>OS\_MAX</sub> is the maximum allowable overshoot above VID). These specifications apply to the processor die voltage as measured across the VCC\_SENSE and VSS\_SENSE lands.

Table 2-16. V<sub>CC</sub> Overshoot Specifications

Symbol	Parameter	Min	Max	Units	Figure	Notes
V <sub>OS_MAX</sub>	Magnitude of V <sub>CCP</sub> overshoot above VID	—	50	mV	2-5	
T <sub>OS_MAX</sub>	Time duration of V <sub>CCP</sub> overshoot above VID	—	25	μs	2-5	

Figure 2-5. V<sub>CC</sub> Overshoot Example Waveform

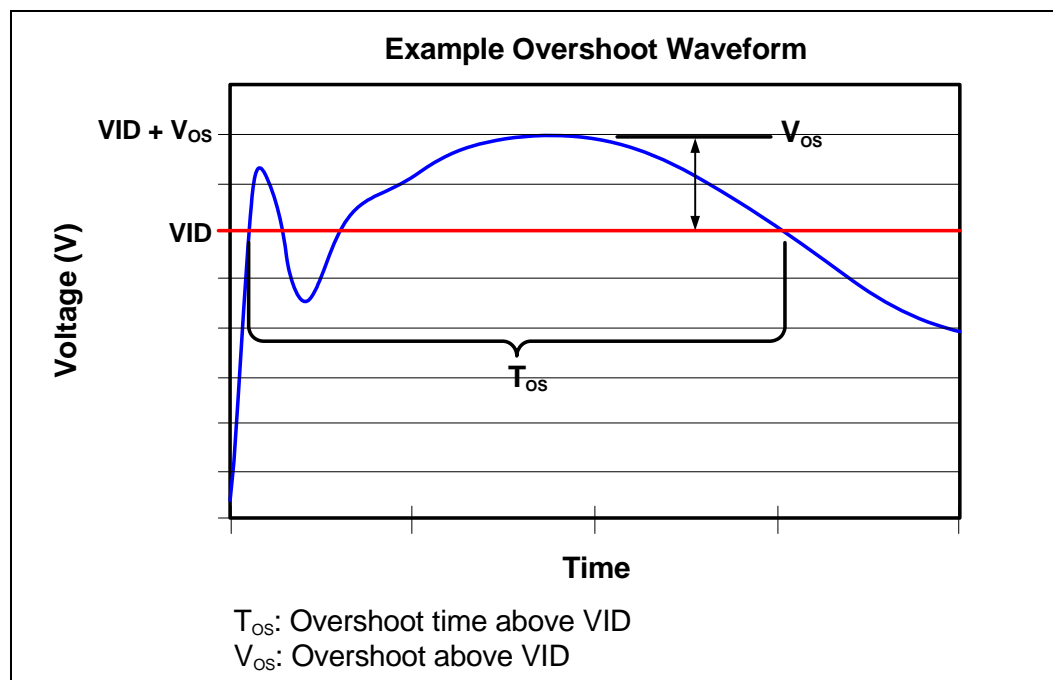

### 2.11.3 Die Voltage Validation

Core voltage (V<sub>CC</sub>) overshoot events at the processor must meet the specifications in Table 2-16 when measured across the VCC\_SENSE and VSS\_SENSE lands. Overshoot events that are < 10 ns in duration may be ignored. These measurements of processor die level overshoot should be taken with a 100 MHz bandwidth limited oscilloscope.



## 2.12 Intel® QuickPath Interconnect (Intel® QPI) Specifications

The processor Intel QPI specifications in this section are defined at the processor pins. Routing topologies are dependent on the processors supported and the chipset used in the design. In most cases, termination resistors are not required as these are integrated into the processor silicon.

**Table 2-17. Intel® QuickPath Interconnect (Intel QPI) Specifications**

Symbol	Parameter	Min	Nom	Max	Unit	Notes
UIavg	Average UI size at "x" GT/s (Where x= 4.8 GT/s, 6.4 GT/s, etc.)	0.999 * nominal	1000/f	1.001 * nominal	psec	
T <sub>slew-rise-fall-pin</sub>	Defined as the slope of the rising or falling waveform as measured between ±100 mV of the differential transmitter output, for any data or clock.	10	—	25	V / nsec	
ΔZ <sub>TX_LOW_CM_DC</sub>	Defined as: ± (max(Z <sub>TX_LOW_CM_DC</sub> ) – min(Z <sub>TX_LOW_CM_DC</sub> )) / Z <sub>TX_LOW_CM_DC</sub> expressed in%, over full range of Tx single ended voltage	-6	0	6	% of Z <sub>TX_LOW_CM_DC</sub>	
ΔZ <sub>RX_LOW_CM_DC</sub>	Defined as: ± (max(Z <sub>TX_LOW_CM_DC</sub> ) – min(Z <sub>TX_LOW_CM_DC</sub> )) / Z <sub>TX_LOW_CM_DC</sub> expressed in%, over full range of Tx single ended voltage	-6	0	6	% of Z <sub>TX_LOW_CM_DC</sub>	
N <sub>MIN-UI-Validation</sub>	# of UI over which the eye mask voltage and timing specification needs to be validated	1,000,000	—	—		
Z <sub>TX_HIGH_CM_DC</sub>	Single ended DC impedance to GND for either D+ or D- of any data bit at Tx	10 k	—	—	Ω	1
Z <sub>RX_HIGH_CM_DC</sub>	Single ended DC impedance to GND for either D+ or D- of any data bit at Tx	10 k	—	—	Ω	2
Z <sub>TX_LINK_DETECT</sub>	Link Detection Resistor	500	—	2000	Ω	
T <sub>Refclk-Tx-Variability</sub>	Phase variability between reference Clk (at Tx input) and Tx output.	—	—	500	psec	
L <sub>D+/D-RX-Skew</sub>	Phase skew between D+ and D- lines for any data bit at Rx	—	—	0.03	UI	
T <sub>CLK_DET</sub>	Time taken by clock detector to observe clock stability	—	—	20K	UI	
T <sub>CLK_FREQ_DET</sub>	Time taken by clock frequency detector to decide slow vs operational clock after stable clock	—	—	32	Reference Clock Cycles	
BER <sub>Lane</sub>	Bit Error Rate per lane valid for 4.8 GT/s and 6.4 GT/s	—	—	1.0E-14	Events	
TX <sub>EQ-error</sub>	% error in Tx equalization setting as measured by errors in DC levels when sending a steady "1".	-10	0	10	% of V <sub>O</sub>	
QPI_CMP[0]	COMP Resistance	20.79	21	21.21	Ω	3

**Notes:**

1. Indicates the output impedance of the transmitter during initialization when the transmitter is "OFF", that is, the output driver is disconnected and only the minimum termination is connected. The link detection resistor is assumed not connected when specifying this parameter.
2. Used during initialization. It is the state of "OFF" condition for the receiver when only the minimum termination is connected.
3. COMP resistance must be provided on the system board with 1% resistors. QPI\_CMP[0] resistors are to V<sub>SS</sub>.



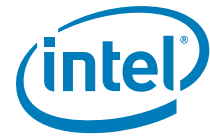

**Table 2-18. Parameter Values for Intel® QuickPath Interconnect (Intel® QPI) Channel at 6.4 GT/s<sup>1</sup>**

Symbol	Parameter	Min	Nom	Max	Unit	Notes
Z <sub>TX_LOW_CM_DC</sub>	DC resistance of Tx terminations at half the single ended swing (which is usually 0.25*V <sub>TX-diff-pp-pin</sub> ) bias point	38	—	52	ohms	
Z <sub>RX_LOW_CM_DC</sub>	DC resistance of Rx terminations at half the single ended swing (which is usually 0.25*V <sub>TX-diff-pp-pin</sub> ) bias point	38	—	52	ohms	
V <sub>TX-diff-pp-pin</sub>	Transmitter Differential swing	800	—	1400	mV	
V <sub>TX-cm-dc-pin</sub>	Transmitter output DC common mode, defined as average of V <sub>D+</sub> and V <sub>D-</sub> .	0.23	—	27		Fraction of V <sub>TX-diff-pp-pin</sub>
V <sub>TX-cm-ac-pin</sub>	Transmitter output AC common mode, defined as ((V <sub>D+</sub> + V <sub>D-</sub> )/2 - V <sub>TX-cm-dc-pin</sub> ).	-0.0375	—	0.0375		Fraction of V <sub>TX-diff-pp-pin</sub>
T <sub>Xduty-pin</sub>	Average of UI-UI jitter	-0.05	—	0.05	UI	
T <sub>XjitUI-UI-1E-7pin</sub>	UI-UI jitter measured at Tx output pins with 1E-7 probability	-0.07	—	0.07	UI	
T <sub>XjitUI-UI-1E-9pin</sub>	UI-UI jitter measured at Tx output pins with 1E-9 probability	-0.075	—	0.075	UI	
T <sub>Xclk-acc-jit-N_UI-1E-7</sub>	P-p accumulated jitter out of any Tx data or clock over 0 ≤ n ≤ N UI where N=12, measured with 1E-7 probability.	0	—	0.18	UI	
T <sub>Xclk-acc-jit-N_UI-1E-9</sub>	P-p accumulated jitter out of any Tx data or clock over 0 ≤ n ≤ N UI where N=12, measured with 1E-9 probability.	0	—	0.2	UI	
T <sub>TX-data-clk-skew-pin</sub>	Delay of any data lane relative to clock lane, as measured at Tx output (UI)	-0.5	—	0.5	UI	
T <sub>Rx-data-clk-skew-pin</sub>	Delay of any data lane relative to the clock lane, as measured at the end of Tx+Channel. This parameter is a collective sum of effects of data clock mismatches in Tx and on the medium connecting Tx and Rx. (UI).	-1	—	4	UI	
V <sub>Rx-cm-dc-pin</sub>	DC common mode ranges at the Rx input for any data or clock channel, defined as average of V <sub>D+</sub> and V <sub>D-</sub> . (mV)	90	—	350	mV	
V <sub>Rx-cm-ac-pin</sub>	AC common mode ranges at the Rx input for any data or clock channel, defined as ((V <sub>D+</sub> + V <sub>D-</sub> )/2 - V <sub>RX-cm-dc-pin</sub> ).	-50	—	50	mV	
T <sub>Rx-margin</sub>	Measured timing margin during receiver margining with any receiver equalizer off	0.1	—		UI	
V <sub>Rx-margin</sub>	Measured voltage margin during receiver margining with receiver equalizer off	40	—		mV	
T <sub>Rx-margin-RxEQ</sub>	Measured timing margin during receiver margining with receiver equalizer on and at the optimum setting that maximizes the timing margin	0.12	—		UI	
V <sub>Rx-margin-RxEQ</sub>	Measured voltage margin during receiver margining with receiver equalizer on and at the optimum setting that maximizes the voltage margin	50	—		mV	

**Notes:**

1. It is expected that the receiver will have equalization, which will boost received voltage and mitigate timing jitter, with the minimum level of swing specified. Platform electrical design should determine the optimum level of equalization necessary, depending on the link.

§

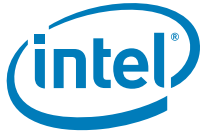

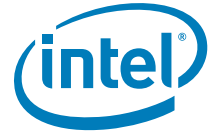

## 3 Package Mechanical Specifications

The processor is packaged in a Flip-Chip Land Grid Array package that interfaces with the motherboard using an LGA1366 socket. The package consists of a processor mounted on a substrate land-carrier. An integrated heat spreader (IHS) is attached to the package substrate and core and serves as the mating surface for processor thermal solutions, such as a heatsink. [Figure 3-1](#) shows a sketch of the processor package components and how they are assembled together. Refer to the appropriate processor Thermal and Mechanical Design Guidelines (see [Section 1.2](#)) for complete details on the LGA1366 socket.

The package components shown in [Figure 3-1](#) include the following:

- Integrated Heat Spreader (IHS)
- Thermal Interface Material (TIM)
- Processor core (die)
- Package substrate
- Capacitors

**Figure 3-1. Processor Package Assembly Sketch**

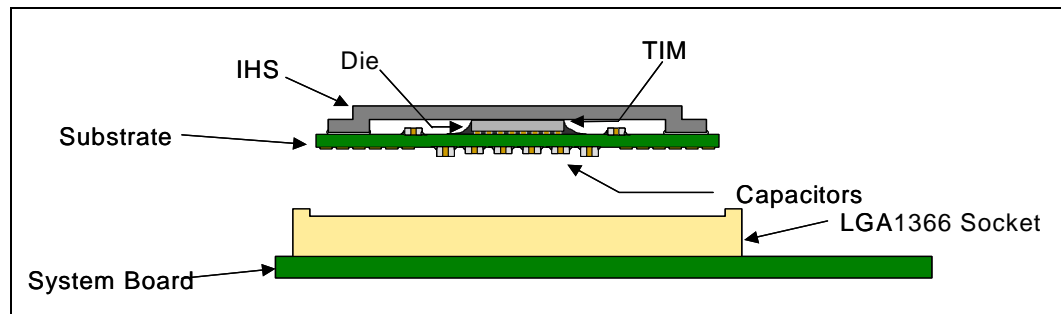

**Note:**

1. Socket and motherboard are included for reference and are not part of the processor package.

### 3.1 Package Mechanical Drawing

The package mechanical drawings are shown in [Figure 3-2](#) and [Figure 3-3](#). The drawings include dimensions necessary to design a thermal solution for the processor. These dimensions include:

- Package reference with tolerances (total height, length, width, etc.)
- IHS parallelism and tilt
- Land dimensions
- Top-side and back-side component keep-out dimensions
- Reference datums
- All drawing dimensions are in mm.
- Guidelines on potential IHS flatness variation with socket load plate actuation and installation of the cooling solution is available in the appropriate processor Thermal and Mechanical Design Guidelines (see [Section 1.2](#)).

Figure 3-2. Processor Package Drawing (Sheet 1 of 2)

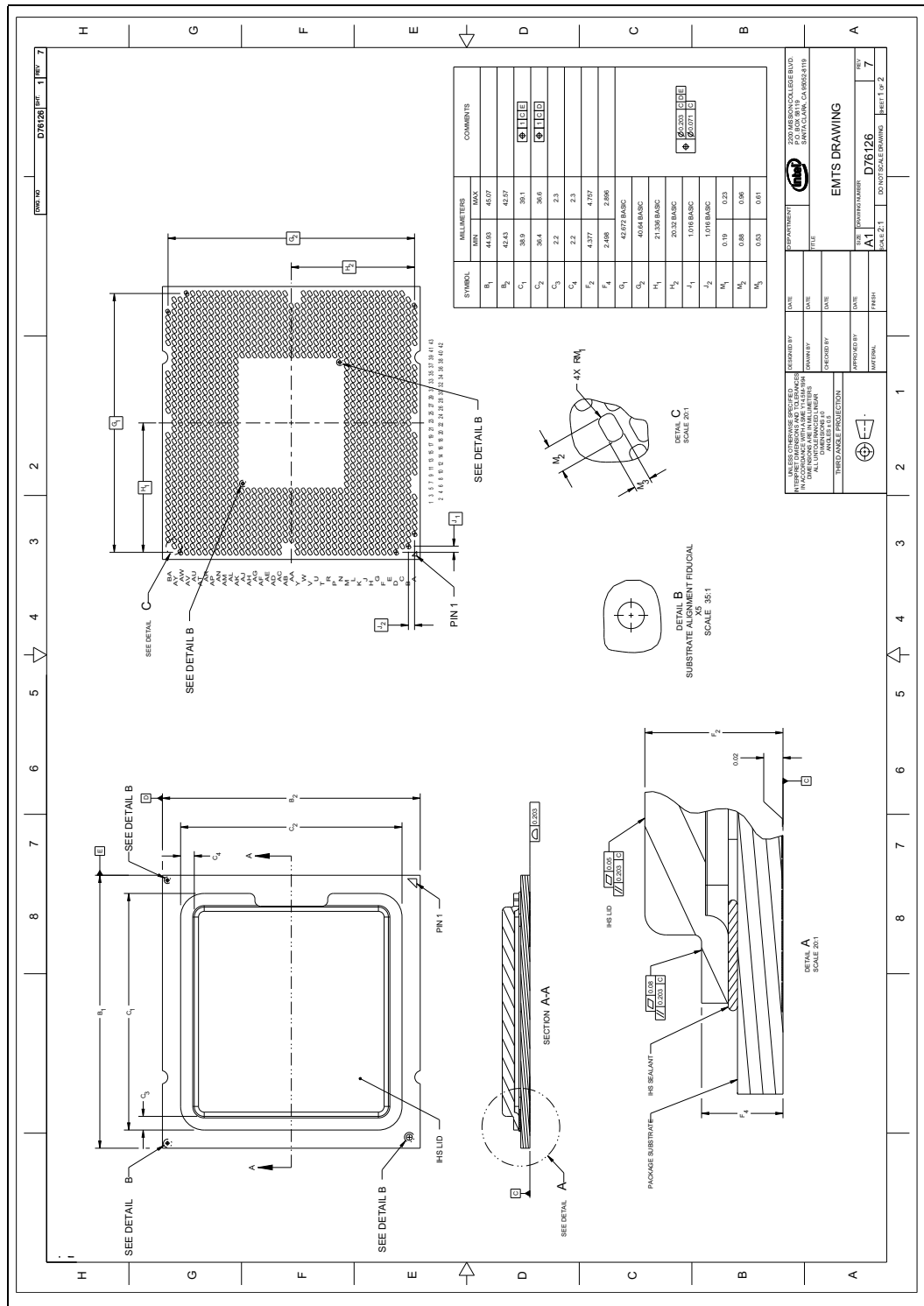
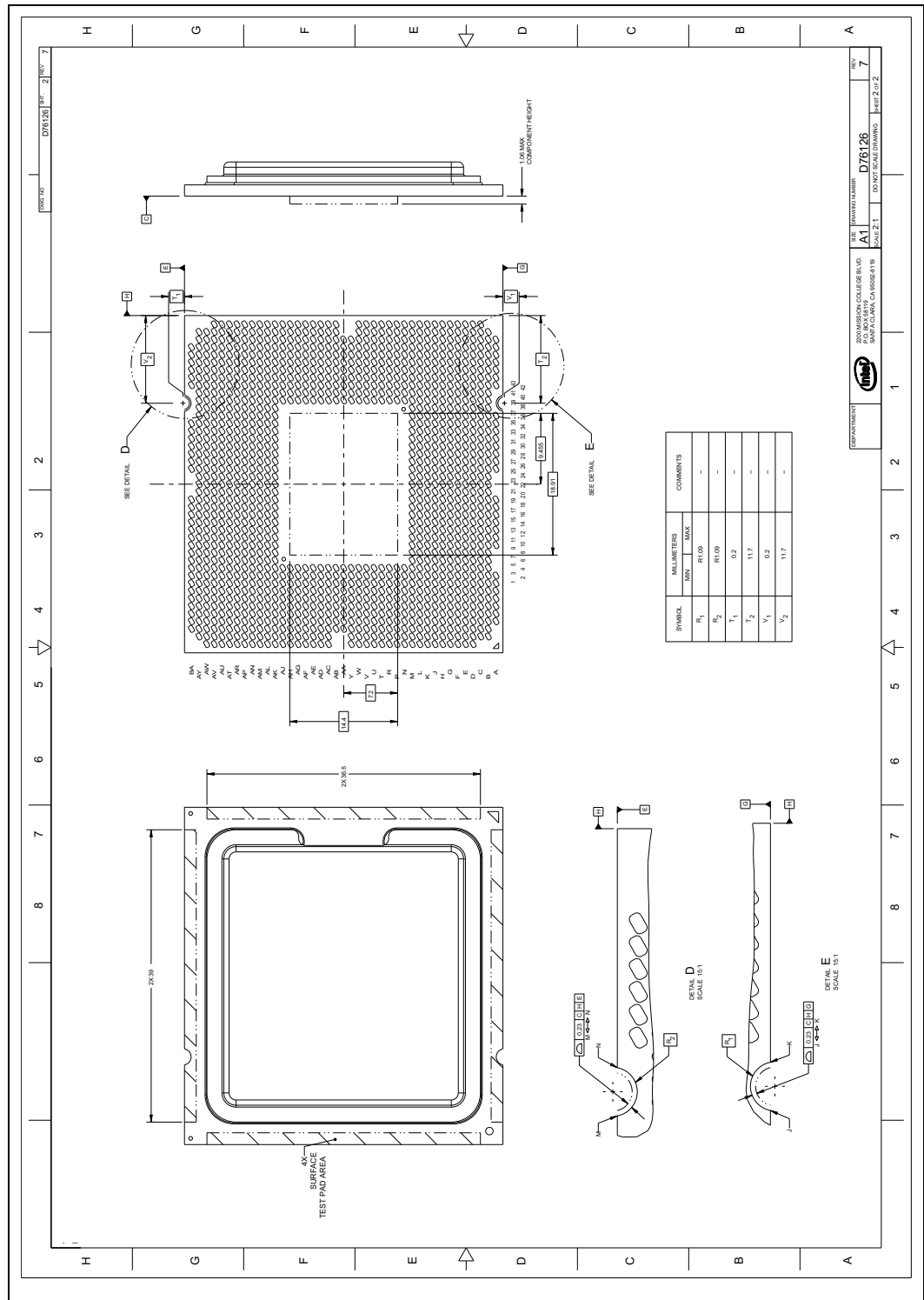
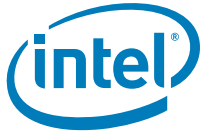



Figure 3-3. Processor Package Drawing (Sheet 2 of 2)





### 3.2 Processor Component Keep-Out Zones

The processor may contain components on the substrate that define component keep-out zone requirements. A thermal and mechanical solution design must not intrude into the required keep-out zones. Decoupling capacitors are typically mounted to either the top-side or land-side of the package substrate. See [Figure 3-2](#) and [Figure 3-3](#) for keep-out zones. The location and quantity of package capacitors may change due to manufacturing efficiencies but will remain within the component keep-in.

### 3.3 Package Loading Specifications

[Table 3-1](#) provides dynamic and static load specifications for the processor package. These mechanical maximum load limits should not be exceeded during heatsink assembly, shipping conditions, or standard use condition. Also, any mechanical system or component testing should not exceed the maximum limits. The processor package substrate should not be used as a mechanical reference or load-bearing surface for thermal and mechanical solution.

**Table 3-1. Processor Loading Specifications**

Parameter	Maximum	Notes
Static Compressive Load	934 N [210 lbf]	1, 2, 3
Dynamic Compressive Load	1834 N [410 lbf] [max static compressive + dynamic load]	1, 3, 4

**Notes:**

1. These specifications apply to uniform compressive loading in a direction normal to the processor IHS.
2. This is the minimum and maximum static force that can be applied by the heatsink and retention solution to maintain the heatsink and processor interface.
3. These specifications are based on limited testing for design characterization. Loading limits are for the package only and do not include the limits of the processor socket.
4. Dynamic loading is defined as an 11 ms duration average load superimposed on the static load requirement.

### 3.4 Package Handling Guidelines

[Table 3-2](#) includes a list of guidelines on package handling in terms of recommended maximum loading on the processor IHS relative to a fixed substrate. These package handling loads may be experienced during heatsink removal.

**Table 3-2. Package Handling Guidelines**

Parameter	Maximum Recommended	Notes
Shear	70 lbs	-
Tensile	25 lbs	-
Torque	35 in.lbs	-

### 3.5 Package Insertion Specifications

The processor can be inserted into and removed from an LGA1366 socket 15 times. The socket should meet the LGA1366 requirements detailed in the appropriate processor Thermal and Mechanical Design Guidelines (see [Section 1.2](#)).

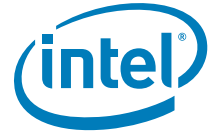

### 3.6 Processor Mass Specification

The typical mass of the processor is 35g. This mass [weight] includes all the components that are included in the package.

### 3.7 Processor Materials

Table 3-3 lists some of the package components and associated materials.

Table 3-3. Processor Materials

Component	Material
Integrated Heat Spreader (IHS)	Nickel Plated Copper
Substrate	Fiber Reinforced Resin
Substrate Lands	Gold Plated Copper

### 3.8 Processor Markings

Figure 3-4 shows the top-side markings on the processor. This diagram is to aid in the identification of the processor.

Figure 3-4. Processor Top-side Markings

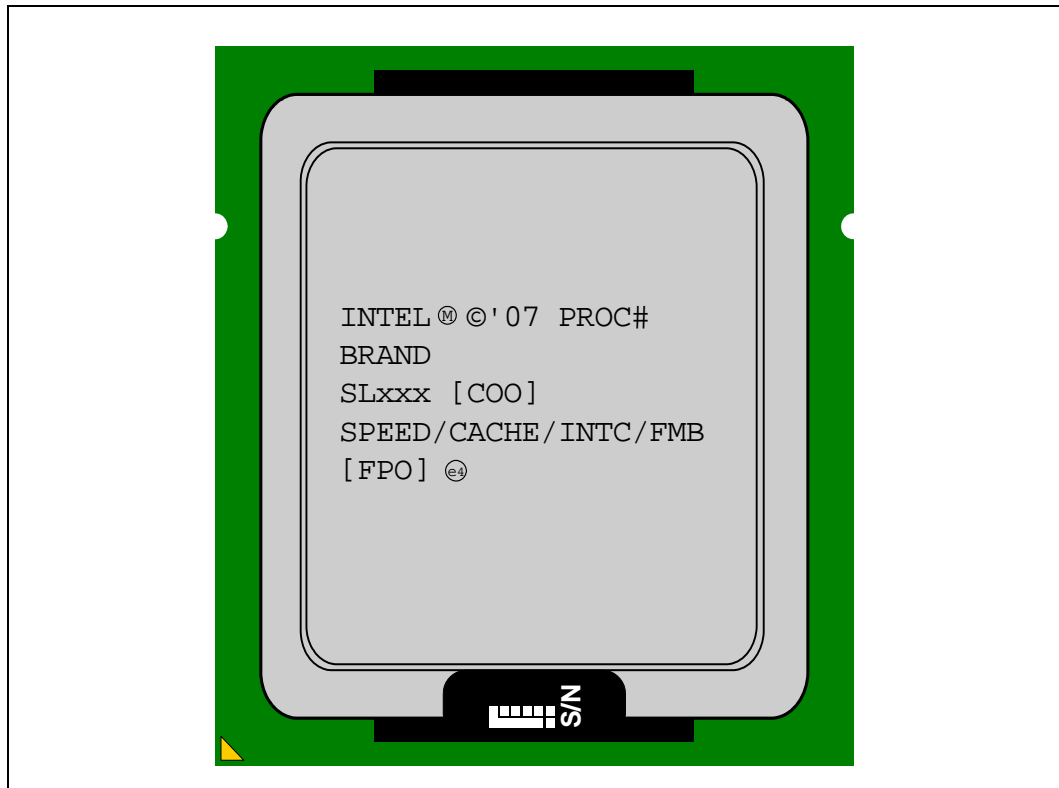

### 3.9 Processor Land Coordinates

Figure 3-5 shows the top view of the processor land coordinates. The coordinates are referred to throughout the document to identify processor lands.

Figure 3-5. Processor Land Coordinates and Quadrants, Top View

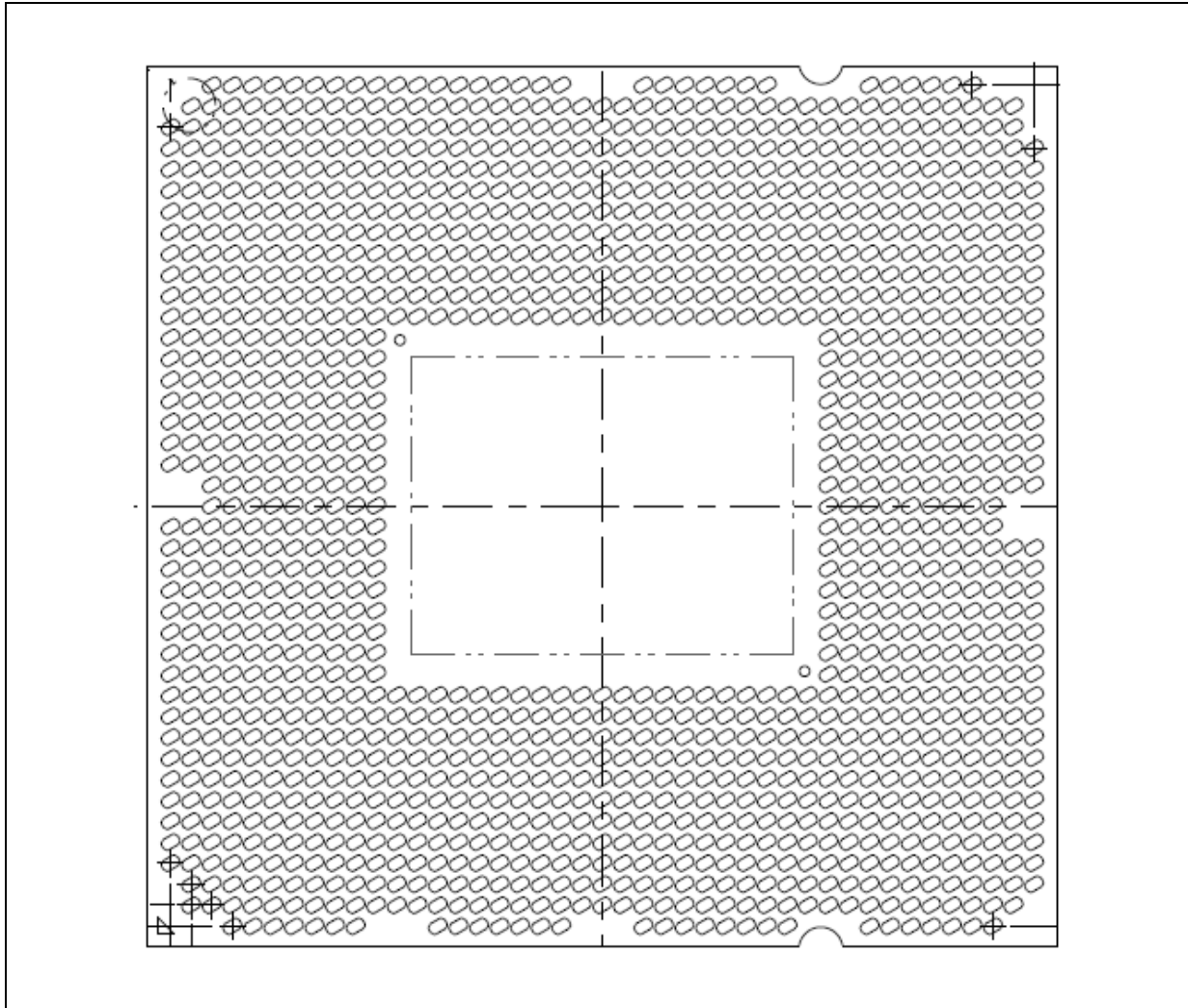

§





## 4 Land Listing

This chapter provides sorted land lists in [Table 4-1](#) and [Table 4-2](#). [Table 4-1](#) is a listing of all processor lands ordered alphabetically by land name. [Table 4-2](#) is a listing of all processor lands ordered by land number.

**Table 4-1. Land Listing by Land Name  
(Sheet 1 of 29)**

Land Name	Land No.	Buffer Type	Direction
BCLK_DN	AH35	CMOS	I
BCLK_DP	AJ35	CMOS	I
BCLK_ITP_DN	AA4	CMOS	O
BCLK_ITP_DP	AA5	CMOS	O
BPM#[0]	B3	GTL	I/O
BPM#[1]	A5	GTL	I/O
BPM#[2]	C2	GTL	I/O
BPM#[3]	B4	GTL	I/O
BPM#[4]	D1	GTL	I/O
BPM#[5]	C3	GTL	I/O
BPM#[6]	D2	GTL	I/O
BPM#[7]	E2	GTL	I/O
CAT_ERR#	AC37	GTL	I/O
COMP0	AB41	Analog	
DBR#	AF10	Asynch	I
DDR_COMP[0]	AA8	Analog	
DDR_COMP[1]	Y7	Analog	
DDR_COMP[2]	AC1	Analog	
DDR_VREF	L23	Analog	I
DDR0_BA[0]	B16	CMOS	O
DDR0_BA[1]	A16	CMOS	O
DDR0_BA[2]	C28	CMOS	O
DDR0_CAS#	C12	CMOS	O
DDR0_CKE[0]	C29	CMOS	O
DDR0_CKE[1]	A30	CMOS	O
DDR0_CKE[2]	B30	CMOS	O
DDR0_CKE[3]	B31	CMOS	O
DDR0_CLK_N[0]	K19	CLOCK	O
DDR0_CLK_N[1]	C19	CLOCK	O
DDR0_CLK_N[2]	E18	CLOCK	O
DDR0_CLK_N[3]	E19	CLOCK	O
DDR0_CLK_P[0]	J19	CLOCK	O
DDR0_CLK_P[1]	D19	CLOCK	O
DDR0_CLK_P[2]	F18	CLOCK	O
DDR0_CLK_P[3]	E20	CLOCK	O
DDR0_CS#[0]	G15	CMOS	O
DDR0_CS#[1]	B10	CMOS	O
DDR0_CS#[4]	B15	CMOS	O

**Table 4-1. Land Listing by Land Name  
(Sheet 2 of 29)**

Land Name	Land No.	Buffer Type	Direction
DDR0_CS#[5]	A7	CMOS	O
DDR0_DQ[0]	W41	CMOS	I/O
DDR0_DQ[1]	V41	CMOS	I/O
DDR0_DQ[2]	R43	CMOS	I/O
DDR0_DQ[3]	R42	CMOS	I/O
DDR0_DQ[4]	W40	CMOS	I/O
DDR0_DQ[5]	W42	CMOS	I/O
DDR0_DQ[6]	U41	CMOS	I/O
DDR0_DQ[7]	T42	CMOS	I/O
DDR0_DQ[8]	N41	CMOS	I/O
DDR0_DQ[9]	N43	CMOS	I/O
DDR0_DQ[10]	K42	CMOS	I/O
DDR0_DQ[11]	K43	CMOS	I/O
DDR0_DQ[12]	P42	CMOS	I/O
DDR0_DQ[13]	P41	CMOS	I/O
DDR0_DQ[14]	L43	CMOS	I/O
DDR0_DQ[15]	L42	CMOS	I/O
DDR0_DQ[16]	H41	CMOS	I/O
DDR0_DQ[17]	H43	CMOS	I/O
DDR0_DQ[18]	E42	CMOS	I/O
DDR0_DQ[19]	E43	CMOS	I/O
DDR0_DQ[20]	J42	CMOS	I/O
DDR0_DQ[21]	J41	CMOS	I/O
DDR0_DQ[22]	F43	CMOS	I/O
DDR0_DQ[23]	F42	CMOS	I/O
DDR0_DQ[24]	D40	CMOS	I/O
DDR0_DQ[25]	C41	CMOS	I/O
DDR0_DQ[26]	A38	CMOS	I/O
DDR0_DQ[27]	D37	CMOS	I/O
DDR0_DQ[28]	D41	CMOS	I/O
DDR0_DQ[29]	D42	CMOS	I/O
DDR0_DQ[30]	C38	CMOS	I/O
DDR0_DQ[31]	B38	CMOS	I/O
DDR0_DQ[32]	B5	CMOS	I/O
DDR0_DQ[33]	C4	CMOS	I/O
DDR0_DQ[34]	F1	CMOS	I/O
DDR0_DQ[35]	G3	CMOS	I/O
DDR0_DQ[36]	B6	CMOS	I/O
DDR0_DQ[37]	C6	CMOS	I/O



**Table 4-1. Land Listing by Land Name  
(Sheet 3 of 29)**

Land Name	Land No.	Buffer Type	Direction
DDR0_DQ[38]	F3	CMOS	I/O
DDR0_DQ[39]	F2	CMOS	I/O
DDR0_DQ[40]	H2	CMOS	I/O
DDR0_DQ[41]	H1	CMOS	I/O
DDR0_DQ[42]	L1	CMOS	I/O
DDR0_DQ[43]	M1	CMOS	I/O
DDR0_DQ[44]	G1	CMOS	I/O
DDR0_DQ[45]	H3	CMOS	I/O
DDR0_DQ[46]	L3	CMOS	I/O
DDR0_DQ[47]	L2	CMOS	I/O
DDR0_DQ[48]	N1	CMOS	I/O
DDR0_DQ[49]	N2	CMOS	I/O
DDR0_DQ[50]	T1	CMOS	I/O
DDR0_DQ[51]	T2	CMOS	I/O
DDR0_DQ[52]	M3	CMOS	I/O
DDR0_DQ[53]	N3	CMOS	I/O
DDR0_DQ[54]	R4	CMOS	I/O
DDR0_DQ[55]	T3	CMOS	I/O
DDR0_DQ[56]	U4	CMOS	I/O
DDR0_DQ[57]	V1	CMOS	I/O
DDR0_DQ[58]	Y2	CMOS	I/O
DDR0_DQ[59]	Y3	CMOS	I/O
DDR0_DQ[60]	U1	CMOS	I/O
DDR0_DQ[61]	U3	CMOS	I/O
DDR0_DQ[62]	V4	CMOS	I/O
DDR0_DQ[63]	W4	CMOS	I/O
DDR0_DQS_N[0]	U43	CMOS	I/O
DDR0_DQS_N[1]	M41	CMOS	I/O
DDR0_DQS_N[2]	G41	CMOS	I/O
DDR0_DQS_N[3]	B40	CMOS	I/O
DDR0_DQS_N[4]	E4	CMOS	I/O
DDR0_DQS_N[5]	K3	CMOS	I/O
DDR0_DQS_N[6]	R3	CMOS	I/O
DDR0_DQS_N[7]	W1	CMOS	I/O
DDR0_DQS_P[0]	T43	CMOS	I/O
DDR0_DQS_P[1]	L41	CMOS	I/O
DDR0_DQS_P[2]	F41	CMOS	I/O
DDR0_DQS_P[3]	B39	CMOS	I/O
DDR0_DQS_P[4]	E3	CMOS	I/O
DDR0_DQS_P[5]	K2	CMOS	I/O
DDR0_DQS_P[6]	R2	CMOS	I/O
DDR0_DQS_P[7]	W2	CMOS	I/O
DDR0_MA[0]	A20	CMOS	O
DDR0_MA[1]	B21	CMOS	O
DDR0_MA[10]	B19	CMOS	O
DDR0_MA[11]	A26	CMOS	O
DDR0_MA[12]	B26	CMOS	O
DDR0_MA[13]	A10	CMOS	O

**Table 4-1. Land Listing by Land Name  
(Sheet 4 of 29)**

Land Name	Land No.	Buffer Type	Direction
DDR0_MA[14]	A28	CMOS	O
DDR0_MA[15]	B29	CMOS	O
DDR0_MA[2]	C23	CMOS	O
DDR0_MA[3]	D24	CMOS	O
DDR0_MA[4]	B23	CMOS	O
DDR0_MA[5]	B24	CMOS	O
DDR0_MA[6]	C24	CMOS	O
DDR0_MA[7]	A25	CMOS	O
DDR0_MA[8]	B25	CMOS	O
DDR0_MA[9]	C26	CMOS	O
DDR0_ODT[0]	F12	CMOS	O
DDR0_ODT[1]	C9	CMOS	O
DDR0_ODT[2]	B11	CMOS	O
DDR0_ODT[3]	C7	CMOS	O
DDR0_RAS#	A15	CMOS	O
DDR0_RESET#	D32	CMOS	O
DDR0_WE#	B13	CMOS	O
DDR1_BA[0]	C18	CMOS	O
DDR1_BA[1]	K13	CMOS	O
DDR1_BA[2]	H27	CMOS	O
DDR1_CAS#	E14	CMOS	O
DDR1_CKE[0]	H28	CMOS	O
DDR1_CKE[1]	E27	CMOS	O
DDR1_CKE[2]	D27	CMOS	O
DDR1_CKE[3]	C27	CMOS	O
DDR1_CLK_N[0]	D21	CLOCK	O
DDR1_CLK_N[1]	G20	CLOCK	O
DDR1_CLK_N[2]	L18	CLOCK	O
DDR1_CLK_N[3]	H19	CLOCK	O
DDR1_CLK_P[0]	C21	CLOCK	O
DDR1_CLK_P[1]	G19	CLOCK	O
DDR1_CLK_P[2]	K18	CLOCK	O
DDR1_CLK_P[3]	H18	CLOCK	O
DDR1_CS#[0]	D12	CMOS	O
DDR1_CS#[1]	A8	CMOS	O
DDR1_CS#[4]	C17	CMOS	O
DDR1_CS#[5]	E10	CMOS	O
DDR1_DQ[0]	AA37	CMOS	I/O
DDR1_DQ[1]	AA36	CMOS	I/O
DDR1_DQ[2]	Y35	CMOS	I/O
DDR1_DQ[3]	Y34	CMOS	I/O
DDR1_DQ[4]	AA35	CMOS	I/O
DDR1_DQ[5]	AB36	CMOS	I/O
DDR1_DQ[6]	Y40	CMOS	I/O
DDR1_DQ[7]	Y39	CMOS	I/O
DDR1_DQ[8]	P34	CMOS	I/O
DDR1_DQ[9]	P35	CMOS	I/O
DDR1_DQ[10]	P39	CMOS	I/O



**Table 4-1. Land Listing by Land Name  
(Sheet 5 of 29)**

Land Name	Land No.	Buffer Type	Direction
DDR1_DQ[11]	N39	CMOS	I/O
DDR1_DQ[12]	R34	CMOS	I/O
DDR1_DQ[13]	R35	CMOS	I/O
DDR1_DQ[14]	N37	CMOS	I/O
DDR1_DQ[15]	N38	CMOS	I/O
DDR1_DQ[16]	M35	CMOS	I/O
DDR1_DQ[17]	M34	CMOS	I/O
DDR1_DQ[18]	K35	CMOS	I/O
DDR1_DQ[19]	J35	CMOS	I/O
DDR1_DQ[20]	N34	CMOS	I/O
DDR1_DQ[21]	M36	CMOS	I/O
DDR1_DQ[22]	J36	CMOS	I/O
DDR1_DQ[23]	H36	CMOS	I/O
DDR1_DQ[24]	H33	CMOS	I/O
DDR1_DQ[25]	L33	CMOS	I/O
DDR1_DQ[26]	K32	CMOS	I/O
DDR1_DQ[27]	J32	CMOS	I/O
DDR1_DQ[28]	J34	CMOS	I/O
DDR1_DQ[29]	H34	CMOS	I/O
DDR1_DQ[30]	L32	CMOS	I/O
DDR1_DQ[31]	K30	CMOS	I/O
DDR1_DQ[32]	E9	CMOS	I/O
DDR1_DQ[33]	E8	CMOS	I/O
DDR1_DQ[34]	E5	CMOS	I/O
DDR1_DQ[35]	F5	CMOS	I/O
DDR1_DQ[36]	F10	CMOS	I/O
DDR1_DQ[37]	G8	CMOS	I/O
DDR1_DQ[38]	D6	CMOS	I/O
DDR1_DQ[39]	F6	CMOS	I/O
DDR1_DQ[40]	H8	CMOS	I/O
DDR1_DQ[41]	J6	CMOS	I/O
DDR1_DQ[42]	G4	CMOS	I/O
DDR1_DQ[43]	H4	CMOS	I/O
DDR1_DQ[44]	G9	CMOS	I/O
DDR1_DQ[45]	H9	CMOS	I/O
DDR1_DQ[46]	G5	CMOS	I/O
DDR1_DQ[47]	J5	CMOS	I/O
DDR1_DQ[48]	K4	CMOS	I/O
DDR1_DQ[49]	K5	CMOS	I/O
DDR1_DQ[50]	R5	CMOS	I/O
DDR1_DQ[51]	T5	CMOS	I/O
DDR1_DQ[52]	J4	CMOS	I/O
DDR1_DQ[53]	M6	CMOS	I/O
DDR1_DQ[54]	R8	CMOS	I/O
DDR1_DQ[55]	R7	CMOS	I/O
DDR1_DQ[56]	W6	CMOS	I/O
DDR1_DQ[57]	W7	CMOS	I/O
DDR1_DQ[58]	Y10	CMOS	I/O

**Table 4-1. Land Listing by Land Name  
(Sheet 6 of 29)**

Land Name	Land No.	Buffer Type	Direction
DDR1_DQ[59]	W10	CMOS	I/O
DDR1_DQ[60]	V9	CMOS	I/O
DDR1_DQ[61]	W5	CMOS	I/O
DDR1_DQ[62]	AA7	CMOS	I/O
DDR1_DQ[63]	W9	CMOS	I/O
DDR1_DQS_N[0]	Y37	CMOS	I/O
DDR1_DQS_N[1]	R37	CMOS	I/O
DDR1_DQS_N[2]	L36	CMOS	I/O
DDR1_DQS_N[3]	L31	CMOS	I/O
DDR1_DQS_N[4]	D7	CMOS	I/O
DDR1_DQS_N[5]	G6	CMOS	I/O
DDR1_DQS_N[6]	L5	CMOS	I/O
DDR1_DQS_N[7]	Y9	CMOS	I/O
DDR1_DQS_P[0]	Y38	CMOS	I/O
DDR1_DQS_P[1]	R38	CMOS	I/O
DDR1_DQS_P[2]	L35	CMOS	I/O
DDR1_DQS_P[3]	L30	CMOS	I/O
DDR1_DQS_P[4]	E7	CMOS	I/O
DDR1_DQS_P[5]	H6	CMOS	I/O
DDR1_DQS_P[6]	L6	CMOS	I/O
DDR1_DQS_P[7]	Y8	CMOS	I/O
DDR1_MA[0]	J14	CMOS	O
DDR1_MA[1]	J16	CMOS	O
DDR1_MA[2]	J17	CMOS	O
DDR1_MA[3]	L28	CMOS	O
DDR1_MA[4]	K28	CMOS	O
DDR1_MA[5]	F22	CMOS	O
DDR1_MA[6]	J27	CMOS	O
DDR1_MA[7]	D22	CMOS	O
DDR1_MA[8]	E22	CMOS	O
DDR1_MA[9]	G24	CMOS	O
DDR1_MA[10]	H14	CMOS	O
DDR1_MA[11]	E23	CMOS	O
DDR1_MA[12]	E24	CMOS	O
DDR1_MA[13]	B14	CMOS	O
DDR1_MA[14]	H26	CMOS	O
DDR1_MA[15]	F26	CMOS	O
DDR1_ODT[0]	D11	CMOS	O
DDR1_ODT[1]	C8	CMOS	O
DDR1_ODT[2]	D14	CMOS	O
DDR1_ODT[3]	F11	CMOS	O
DDR1_RAS#	G14	CMOS	O
DDR1_RESET#	D29	CMOS	O
DDR1_WE#	G13	CMOS	O
DDR2_BA[0]	A17	CMOS	O
DDR2_BA[1]	F17	CMOS	O
DDR2_BA[2]	L26	CMOS	O
DDR2_CAS#	F16	CMOS	O



**Table 4-1. Land Listing by Land Name  
(Sheet 7 of 29)**

Land Name	Land No.	Buffer Type	Direction
DDR2_CKE[0]	J26	CMOS	O
DDR2_CKE[1]	G26	CMOS	O
DDR2_CKE[2]	D26	CMOS	O
DDR2_CKE[3]	L27	CMOS	O
DDR2_CLK_N[0]	J21	CLOCK	O
DDR2_CLK_N[1]	K20	CLOCK	O
DDR2_CLK_N[2]	G21	CLOCK	O
DDR2_CLK_N[3]	L21	CLOCK	O
DDR2_CLK_P[0]	J22	CLOCK	O
DDR2_CLK_P[1]	L20	CLOCK	O
DDR2_CLK_P[2]	H21	CLOCK	O
DDR2_CLK_P[3]	L22	CLOCK	O
DDR2_CS#[0]	G16	CMOS	O
DDR2_CS#[1]	K14	CMOS	O
DDR2_CS#[4]	E17	CMOS	O
DDR2_CS#[5]	D9	CMOS	O
DDR2_DQ[0]	W34	CMOS	I/O
DDR2_DQ[1]	W35	CMOS	I/O
DDR2_DQ[2]	V36	CMOS	I/O
DDR2_DQ[3]	U36	CMOS	I/O
DDR2_DQ[4]	U34	CMOS	I/O
DDR2_DQ[5]	V34	CMOS	I/O
DDR2_DQ[6]	V37	CMOS	I/O
DDR2_DQ[7]	V38	CMOS	I/O
DDR2_DQ[8]	U38	CMOS	I/O
DDR2_DQ[9]	U39	CMOS	I/O
DDR2_DQ[10]	R39	CMOS	I/O
DDR2_DQ[11]	T36	CMOS	I/O
DDR2_DQ[12]	W39	CMOS	I/O
DDR2_DQ[13]	V39	CMOS	I/O
DDR2_DQ[14]	T41	CMOS	I/O
DDR2_DQ[15]	R40	CMOS	I/O
DDR2_DQ[16]	M39	CMOS	I/O
DDR2_DQ[17]	M40	CMOS	I/O
DDR2_DQ[18]	J40	CMOS	I/O
DDR2_DQ[19]	J39	CMOS	I/O
DDR2_DQ[20]	P40	CMOS	I/O
DDR2_DQ[21]	N36	CMOS	I/O
DDR2_DQ[22]	L40	CMOS	I/O
DDR2_DQ[23]	K38	CMOS	I/O
DDR2_DQ[24]	G40	CMOS	I/O
DDR2_DQ[25]	F40	CMOS	I/O
DDR2_DQ[26]	J37	CMOS	I/O
DDR2_DQ[27]	H37	CMOS	I/O
DDR2_DQ[28]	H39	CMOS	I/O
DDR2_DQ[29]	G39	CMOS	I/O
DDR2_DQ[30]	F38	CMOS	I/O
DDR2_DQ[31]	E38	CMOS	I/O

**Table 4-1. Land Listing by Land Name  
(Sheet 8 of 29)**

Land Name	Land No.	Buffer Type	Direction
DDR2_DQ[32]	K12	CMOS	I/O
DDR2_DQ[33]	J12	CMOS	I/O
DDR2_DQ[34]	H13	CMOS	I/O
DDR2_DQ[35]	L13	CMOS	I/O
DDR2_DQ[36]	G11	CMOS	I/O
DDR2_DQ[37]	G10	CMOS	I/O
DDR2_DQ[38]	H12	CMOS	I/O
DDR2_DQ[39]	L12	CMOS	I/O
DDR2_DQ[40]	L10	CMOS	I/O
DDR2_DQ[41]	K10	CMOS	I/O
DDR2_DQ[42]	M9	CMOS	I/O
DDR2_DQ[43]	N9	CMOS	I/O
DDR2_DQ[44]	L11	CMOS	I/O
DDR2_DQ[45]	M10	CMOS	I/O
DDR2_DQ[46]	L8	CMOS	I/O
DDR2_DQ[47]	M8	CMOS	I/O
DDR2_DQ[48]	P7	CMOS	I/O
DDR2_DQ[49]	N6	CMOS	I/O
DDR2_DQ[50]	P9	CMOS	I/O
DDR2_DQ[51]	P10	CMOS	I/O
DDR2_DQ[52]	N8	CMOS	I/O
DDR2_DQ[53]	N7	CMOS	I/O
DDR2_DQ[54]	R10	CMOS	I/O
DDR2_DQ[55]	R9	CMOS	I/O
DDR2_DQ[56]	U5	CMOS	I/O
DDR2_DQ[57]	U6	CMOS	I/O
DDR2_DQ[58]	T10	CMOS	I/O
DDR2_DQ[59]	U10	CMOS	I/O
DDR2_DQ[60]	T6	CMOS	I/O
DDR2_DQ[61]	T7	CMOS	I/O
DDR2_DQ[62]	V8	CMOS	I/O
DDR2_DQ[63]	U9	CMOS	I/O
DDR2_DQS_N[0]	W36	CMOS	I/O
DDR2_DQS_N[1]	T38	CMOS	I/O
DDR2_DQS_N[2]	K39	CMOS	I/O
DDR2_DQS_N[3]	E40	CMOS	I/O
DDR2_DQS_N[4]	J9	CMOS	I/O
DDR2_DQS_N[5]	K7	CMOS	I/O
DDR2_DQS_N[6]	P5	CMOS	I/O
DDR2_DQS_N[7]	T8	CMOS	I/O
DDR2_DQS_P[0]	W37	CMOS	I/O
DDR2_DQS_P[1]	T37	CMOS	I/O
DDR2_DQS_P[2]	K40	CMOS	I/O
DDR2_DQS_P[3]	E39	CMOS	I/O
DDR2_DQS_P[4]	J10	CMOS	I/O
DDR2_DQS_P[5]	L7	CMOS	I/O
DDR2_DQS_P[6]	P6	CMOS	I/O
DDR2_DQS_P[7]	U8	CMOS	I/O



**Table 4-1. Land Listing by Land Name  
(Sheet 9 of 29)**

Land Name	Land No.	Buffer Type	Direction
DDR2_MA[0]	A18	CMOS	O
DDR2_MA[1]	K17	CMOS	O
DDR2_MA[2]	G18	CMOS	O
DDR2_MA[3]	J20	CMOS	O
DDR2_MA[4]	F20	CMOS	O
DDR2_MA[5]	K23	CMOS	O
DDR2_MA[6]	K22	CMOS	O
DDR2_MA[7]	J24	CMOS	O
DDR2_MA[8]	L25	CMOS	O
DDR2_MA[9]	H22	CMOS	O
DDR2_MA[10]	H17	CMOS	O
DDR2_MA[11]	H23	CMOS	O
DDR2_MA[12]	G23	CMOS	O
DDR2_MA[13]	F15	CMOS	O
DDR2_MA[14]	H24	CMOS	O
DDR2_MA[15]	G25	CMOS	O
DDR2_ODT[0]	L16	CMOS	O
DDR2_ODT[1]	F13	CMOS	O
DDR2_ODT[2]	D15	CMOS	O
DDR2_ODT[3]	D10	CMOS	O
DDR2_RAS#	D17	CMOS	O
DDR2_RESET#	E32	CMOS	O
DDR2_WE#	C16	CMOS	O
FC_AH5	AH5		
ISENSE	AK8	Analog	I
PECI	AH36	Asynch	I/O
PRDY#	B41	GTL	O
PREQ#	C42	GTL	I
PROCHOT#	AG35	GTL	I/O
PSI#	AP7	CMOS	O
QPI_CLKRX_DN	AR42	QPI	I
QPI_CLKRX_DP	AR41	QPI	I
QPI_CLKTX_DN	AF42	QPI	O
QPI_CLKTX_DP	AG42	QPI	O
QPI_CMP[0]	AL43	Analog	
QPI_DRX_DN[0]	AU37	QPI	I
QPI_DRX_DN[1]	AV38	QPI	I
QPI_DRX_DN[2]	AV37	QPI	I
QPI_DRX_DN[3]	AY36	QPI	I
QPI_DRX_DN[4]	BA37	QPI	I
QPI_DRX_DN[5]	AW38	QPI	I
QPI_DRX_DN[6]	AY38	QPI	I
QPI_DRX_DN[7]	AT39	QPI	I
QPI_DRX_DN[8]	AV40	QPI	I
QPI_DRX_DN[9]	AU41	QPI	I
QPI_DRX_DN[10]	AT42	QPI	I
QPI_DRX_DN[11]	AR43	QPI	I
QPI_DRX_DN[12]	AR40	QPI	I

**Table 4-1. Land Listing by Land Name  
(Sheet 10 of 29)**

Land Name	Land No.	Buffer Type	Direction
QPI_DRX_DN[13]	AN42	QPI	I
QPI_DRX_DN[14]	AM43	QPI	I
QPI_DRX_DN[15]	AM40	QPI	I
QPI_DRX_DN[16]	AM41	QPI	I
QPI_DRX_DN[17]	AP40	QPI	I
QPI_DRX_DN[18]	AP39	QPI	I
QPI_DRX_DN[19]	AR38	QPI	I
QPI_DRX_DP[0]	AT37	QPI	I
QPI_DRX_DP[1]	AU38	QPI	I
QPI_DRX_DP[2]	AV36	QPI	I
QPI_DRX_DP[3]	AW36	QPI	I
QPI_DRX_DP[4]	BA36	QPI	I
QPI_DRX_DP[5]	AW37	QPI	I
QPI_DRX_DP[6]	BA38	QPI	I
QPI_DRX_DP[7]	AU39	QPI	I
QPI_DRX_DP[8]	AW40	QPI	I
QPI_DRX_DP[9]	AU40	QPI	I
QPI_DRX_DP[10]	AU42	QPI	I
QPI_DRX_DP[11]	AT43	QPI	I
QPI_DRX_DP[12]	AT40	QPI	I
QPI_DRX_DP[13]	AP42	QPI	I
QPI_DRX_DP[14]	AN43	QPI	I
QPI_DRX_DP[15]	AN40	QPI	I
QPI_DRX_DP[16]	AM42	QPI	I
QPI_DRX_DP[17]	AP41	QPI	I
QPI_DRX_DP[18]	AN39	QPI	I
QPI_DRX_DP[19]	AP38	QPI	I
QPI_DTX_DN[0]	AH38	QPI	O
QPI_DTX_DN[1]	AG39	QPI	O
QPI_DTX_DN[2]	AK38	QPI	O
QPI_DTX_DN[3]	AJ39	QPI	O
QPI_DTX_DN[4]	AJ40	QPI	O
QPI_DTX_DN[5]	AK41	QPI	O
QPI_DTX_DN[6]	AH42	QPI	O
QPI_DTX_DN[7]	AJ42	QPI	O
QPI_DTX_DN[8]	AH43	QPI	O
QPI_DTX_DN[9]	AG41	QPI	O
QPI_DTX_DN[10]	AE43	QPI	O
QPI_DTX_DN[11]	AE41	QPI	O
QPI_DTX_DN[12]	AC42	QPI	O
QPI_DTX_DN[13]	AB43	QPI	O
QPI_DTX_DN[14]	AD39	QPI	O
QPI_DTX_DN[15]	AC40	QPI	O
QPI_DTX_DN[16]	AC38	QPI	O
QPI_DTX_DN[17]	AB38	QPI	O
QPI_DTX_DN[18]	AE38	QPI	O
QPI_DTX_DN[19]	AF40	QPI	O
QPI_DTX_DP[0]	AG38	QPI	O

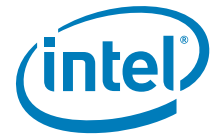

**Table 4-1. Land Listing by Land Name  
(Sheet 11 of 29)**

Land Name	Land No.	Buffer Type	Direction
QPI_DTX_DP[1]	AF39	QPI	O
QPI_DTX_DP[2]	AK37	QPI	O
QPI_DTX_DP[3]	AJ38	QPI	O
QPI_DTX_DP[4]	AH40	QPI	O
QPI_DTX_DP[5]	AK40	QPI	O
QPI_DTX_DP[6]	AH41	QPI	O
QPI_DTX_DP[7]	AK42	QPI	O
QPI_DTX_DP[8]	AJ43	QPI	O
QPI_DTX_DP[9]	AG40	QPI	O
QPI_DTX_DP[10]	AF43	QPI	O
QPI_DTX_DP[11]	AE42	QPI	O
QPI_DTX_DP[12]	AD42	QPI	O
QPI_DTX_DP[13]	AC43	QPI	O
QPI_DTX_DP[14]	AD40	QPI	O
QPI_DTX_DP[15]	AC41	QPI	O
QPI_DTX_DP[16]	AC39	QPI	O
QPI_DTX_DP[17]	AB39	QPI	O
QPI_DTX_DP[18]	AD38	QPI	O
QPI_DTX_DP[19]	AE40	QPI	O
RESET#	AL39	Asynch	I
RSVD	D35		
RSVD	D34		
RSVD	C36		
RSVD	A36		
RSVD	F32		
RSVD	C33		
RSVD	C37		
RSVD	A37		
RSVD	B34		
RSVD	C34		
RSVD	G34		
RSVD	G33		
RSVD	D36		
RSVD	F36		
RSVD	E33		
RSVD	G36		
RSVD	E37		
RSVD	F37		
RSVD	E34		
RSVD	G35		
RSVD	G30		
RSVD	G29		
RSVD	H32		
RSVD	F33		
RSVD	E29		
RSVD	E30		
RSVD	J31		
RSVD	J30		

**Table 4-1. Land Listing by Land Name  
(Sheet 12 of 29)**

Land Name	Land No.	Buffer Type	Direction
RSVD	F31		
RSVD	F30		
RSVD	AB5		
RSVD	C13		
RSVD	B9		
RSVD	C11		
RSVD	B8		
RSVD	M43		
RSVD	G43		
RSVD	C39		
RSVD	D4		
RSVD	J1		
RSVD	P1		
RSVD	V3		
RSVD	B35		
RSVD	V42		
RSVD	N42		
RSVD	H42		
RSVD	D39		
RSVD	D5		
RSVD	J2		
RSVD	P2		
RSVD	V2		
RSVD	B36		
RSVD	V43		
RSVD	B20		
RSVD	D25		
RSVD	B28		
RSVD	A27		
RSVD	E15		
RSVD	E13		
RSVD	C14		
RSVD	E12		
RSVD	P37		
RSVD	E35		
RSVD	K37		
RSVD	K33		
RSVD	F7		
RSVD	J7		
RSVD	M4		
RSVD	Y5		
RSVD	AA41		
RSVD	P36		
RSVD	L37		
RSVD	K34		
RSVD	F8		
RSVD	H7		
RSVD	M5		



**Table 4-1. Land Listing by Land Name  
(Sheet 13 of 29)**

Land Name	Land No.	Buffer Type	Direction
RSVD	Y4		
RSVD	F35		
RSVD	AA40		
RSVD	D20		
RSVD	C22		
RSVD	E25		
RSVD	F25		
RSVD	D16		
RSVD	H16		
RSVD	L17		
RSVD	J15		
RSVD	T40		
RSVD	L38		
RSVD	G38		
RSVD	J11		
RSVD	K8		
RSVD	P4		
RSVD	V7		
RSVD	G31		
RSVD	T35		
RSVD	U40		
RSVD	M38		
RSVD	H38		
RSVD	H11		
RSVD	K9		
RSVD	N4		
RSVD	V6		
RSVD	H31		
RSVD	U35		
RSVD	B18		
RSVD	F21		
RSVD	J25		
RSVD	F23		
RSVD	A31		
RSVD	A40		
RSVD	AB3		
RSVD	AB6		
RSVD	AC3		
RSVD	AC4		
RSVD	AC6		
RSVD	AC8		
RSVD	AD1		
RSVD	AD2		
RSVD	AD3		
RSVD	AD4		
RSVD	AD5		
RSVD	AD6		
RSVD	AD7		

**Table 4-1. Land Listing by Land Name  
(Sheet 14 of 29)**

Land Name	Land No.	Buffer Type	Direction
RSVD	AD8		
RSVD	AE1		
RSVD	AE3		
RSVD	AE4		
RSVD	AE5		
RSVD	AE6		
RSVD	AF1		
RSVD	AF2		
RSVD	AF3		
RSVD	AF4		
RSVD	AF6		
RSVD	AG1		
RSVD	AG2		
RSVD	AG4		
RSVD	AG5		
RSVD	AG6		
RSVD	AG7		
RSVD	AG8		
RSVD	AH2		
RSVD	AH3		
RSVD	AH4		
RSVD	AH6		
RSVD	AH8		
RSVD	AJ1		
RSVD	AJ2		
RSVD	AJ3		
RSVD	AJ37		
RSVD	AJ4		
RSVD	AJ6		
RSVD	AJ7		
RSVD	AJ8		
RSVD	AK1		
RSVD	AK2		
RSVD	AK35		
RSVD	AK36		
RSVD	AK4		
RSVD	AK5		
RSVD	AK6		
RSVD	AL3		
RSVD	AL38		
RSVD	AL4		
RSVD	AL40		
RSVD	AL41		
RSVD	AL5		
RSVD	AL6		
RSVD	AL8		
RSVD	AM1		
RSVD	AM2		



**Table 4-1. Land Listing by Land Name  
(Sheet 15 of 29)**

Land Name	Land No.	Buffer Type	Direction
RSVD	AM3		
RSVD	AM36		
RSVD	AM38		
RSVD	AM4		
RSVD	AM6		
RSVD	AM7		
RSVD	AM8		
RSVD	AN1		
RSVD	AN2		
RSVD	AN36		
RSVD	AN38		
RSVD	AN4		
RSVD	AN5		
RSVD	AN6		
RSVD	AP2		
RSVD	AP3		
RSVD	AP4		
RSVD	AR1		
RSVD	AR36		
RSVD	AR37		
RSVD	AR4		
RSVD	AR5		
RSVD	AR6		
RSVD	AT1		
RSVD	AT2		
RSVD	AT3		
RSVD	AT36		
RSVD	AT4		
RSVD	AT5		
RSVD	AT6		
RSVD	AU2		
RSVD	AU3		
RSVD	AU4		
RSVD	AU6		
RSVD	AU7		
RSVD	AU8		
RSVD	AV1		
RSVD	AV2		
RSVD	AV35		
RSVD	AV42		
RSVD	AV43		
RSVD	AV5		
RSVD	AV7		
RSVD	AV8		
RSVD	AW2		
RSVD	AW3		
RSVD	AW39		
RSVD	AW4		

**Table 4-1. Land Listing by Land Name  
(Sheet 16 of 29)**

Land Name	Land No.	Buffer Type	Direction
RSVD	AW41		
RSVD	AW42		
RSVD	AW5		
RSVD	AW7		
RSVD	AY3		
RSVD	AY35		
RSVD	AY39		
RSVD	AY4		
RSVD	AY40		
RSVD	AY41		
RSVD	AY5		
RSVD	AY6		
RSVD	AY8		
RSVD	B33		
RSVD	BA4		
RSVD	BA40		
RSVD	BA6		
RSVD	BA7		
RSVD	BA8		
RSVD	C31		
RSVD	C32		
RSVD	D30		
RSVD	D31		
RSVD	E28		
RSVD	F27		
RSVD	F28		
RSVD	G28		
RSVD	H29		
RSVD	J29		
RSVD	K15		
RSVD	K24		
RSVD	K25		
RSVD	K27		
RSVD	K29		
RSVD	L15		
RSVD	U11		
RSVD	V11		
RSVD	AK7		
SKTOCC#	AG36	GTL	O
TCK	AH10	TAP	I
TDI	AJ9	TAP	I
TDO	AJ10	TAP	O
THERMTRIP#	AG37	GTL	O
TMS	AG10	TAP	I
TRST#	AH9	TAP	I
VCC	AH11	PWR	
VCC	AH33	PWR	
VCC	AJ11	PWR	





**Table 4-1. Land Listing by Land Name  
(Sheet 17 of 29)**

Land Name	Land No.	Buffer Type	Direction
VCC	AJ33	PWR	
VCC	AK11	PWR	
VCC	AK12	PWR	
VCC	AK13	PWR	
VCC	AK15	PWR	
VCC	AK16	PWR	
VCC	AK18	PWR	
VCC	AK19	PWR	
VCC	AK21	PWR	
VCC	AK24	PWR	
VCC	AK25	PWR	
VCC	AK27	PWR	
VCC	AK28	PWR	
VCC	AK30	PWR	
VCC	AK31	PWR	
VCC	AK33	PWR	
VCC	AL12	PWR	
VCC	AL13	PWR	
VCC	AL15	PWR	
VCC	AL16	PWR	
VCC	AL18	PWR	
VCC	AL19	PWR	
VCC	AL21	PWR	
VCC	AL24	PWR	
VCC	AL25	PWR	
VCC	AL27	PWR	
VCC	AL28	PWR	
VCC	AL30	PWR	
VCC	AL31	PWR	
VCC	AL33	PWR	
VCC	AL34	PWR	
VCC	AM12	PWR	
VCC	AM13	PWR	
VCC	AM15	PWR	
VCC	AM16	PWR	
VCC	AM18	PWR	
VCC	AM19	PWR	
VCC	AM21	PWR	
VCC	AM24	PWR	
VCC	AM25	PWR	
VCC	AM27	PWR	
VCC	AM28	PWR	
VCC	AM30	PWR	
VCC	AM31	PWR	
VCC	AM33	PWR	
VCC	AM34	PWR	
VCC	AN12	PWR	
VCC	AN13	PWR	

**Table 4-1. Land Listing by Land Name  
(Sheet 18 of 29)**

Land Name	Land No.	Buffer Type	Direction
VCC	AN15	PWR	
VCC	AN16	PWR	
VCC	AN18	PWR	
VCC	AN19	PWR	
VCC	AN21	PWR	
VCC	AN24	PWR	
VCC	AN25	PWR	
VCC	AN27	PWR	
VCC	AN28	PWR	
VCC	AN30	PWR	
VCC	AN31	PWR	
VCC	AN33	PWR	
VCC	AN34	PWR	
VCC	AP12	PWR	
VCC	AP13	PWR	
VCC	AP15	PWR	
VCC	AP16	PWR	
VCC	AP18	PWR	
VCC	AP19	PWR	
VCC	AP21	PWR	
VCC	AP24	PWR	
VCC	AP25	PWR	
VCC	AP27	PWR	
VCC	AP28	PWR	
VCC	AP30	PWR	
VCC	AP31	PWR	
VCC	AP33	PWR	
VCC	AP34	PWR	
VCC	AR10	PWR	
VCC	AR12	PWR	
VCC	AR13	PWR	
VCC	AR15	PWR	
VCC	AR16	PWR	
VCC	AR18	PWR	
VCC	AR19	PWR	
VCC	AR21	PWR	
VCC	AR24	PWR	
VCC	AR25	PWR	
VCC	AR27	PWR	
VCC	AR28	PWR	
VCC	AR30	PWR	
VCC	AR31	PWR	
VCC	AR33	PWR	
VCC	AR34	PWR	
VCC	AT10	PWR	
VCC	AT12	PWR	
VCC	AT13	PWR	
VCC	AT15	PWR	



**Table 4-1. Land Listing by Land Name  
(Sheet 19 of 29)**

Land Name	Land No.	Buffer Type	Direction
VCC	AT16	PWR	
VCC	AT18	PWR	
VCC	AT19	PWR	
VCC	AT21	PWR	
VCC	AT24	PWR	
VCC	AT25	PWR	
VCC	AT27	PWR	
VCC	AT28	PWR	
VCC	AT30	PWR	
VCC	AT31	PWR	
VCC	AT33	PWR	
VCC	AT34	PWR	
VCC	AT9	PWR	
VCC	AU10	PWR	
VCC	AU12	PWR	
VCC	AU13	PWR	
VCC	AU15	PWR	
VCC	AU16	PWR	
VCC	AU18	PWR	
VCC	AU19	PWR	
VCC	AU21	PWR	
VCC	AU24	PWR	
VCC	AU25	PWR	
VCC	AU27	PWR	
VCC	AU28	PWR	
VCC	AU30	PWR	
VCC	AU31	PWR	
VCC	AU33	PWR	
VCC	AU34	PWR	
VCC	AU9	PWR	
VCC	AV10	PWR	
VCC	AV12	PWR	
VCC	AV13	PWR	
VCC	AV15	PWR	
VCC	AV16	PWR	
VCC	AV18	PWR	
VCC	AV19	PWR	
VCC	AV21	PWR	
VCC	AV24	PWR	
VCC	AV25	PWR	
VCC	AV27	PWR	
VCC	AV28	PWR	
VCC	AV30	PWR	
VCC	AV31	PWR	
VCC	AV33	PWR	
VCC	AV34	PWR	
VCC	AV9	PWR	
VCC	AW10	PWR	

**Table 4-1. Land Listing by Land Name  
(Sheet 20 of 29)**

Land Name	Land No.	Buffer Type	Direction
VCC	AW12	PWR	
VCC	AW13	PWR	
VCC	AW15	PWR	
VCC	AW16	PWR	
VCC	AW18	PWR	
VCC	AW19	PWR	
VCC	AW21	PWR	
VCC	AW24	PWR	
VCC	AW25	PWR	
VCC	AW27	PWR	
VCC	AW28	PWR	
VCC	AW30	PWR	
VCC	AW31	PWR	
VCC	AW33	PWR	
VCC	AW34	PWR	
VCC	AW9	PWR	
VCC	AY10	PWR	
VCC	AY12	PWR	
VCC	AY13	PWR	
VCC	AY15	PWR	
VCC	AY16	PWR	
VCC	AY18	PWR	
VCC	AY19	PWR	
VCC	AY21	PWR	
VCC	AY24	PWR	
VCC	AY25	PWR	
VCC	AY27	PWR	
VCC	AY28	PWR	
VCC	AY30	PWR	
VCC	AY31	PWR	
VCC	AY33	PWR	
VCC	AY34	PWR	
VCC	AY9	PWR	
VCC	BA10	PWR	
VCC	BA12	PWR	
VCC	BA13	PWR	
VCC	BA15	PWR	
VCC	BA16	PWR	
VCC	BA18	PWR	
VCC	BA19	PWR	
VCC	BA24	PWR	
VCC	BA25	PWR	
VCC	BA27	PWR	
VCC	BA28	PWR	
VCC	BA30	PWR	
VCC	BA9	PWR	
VCC	M11	PWR	
VCC	M13	PWR	

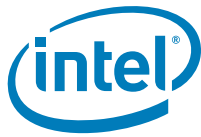

**Table 4-1. Land Listing by Land Name  
(Sheet 21 of 29)**

Land Name	Land No.	Buffer Type	Direction
VCC	M15	PWR	
VCC	M19	PWR	
VCC	M21	PWR	
VCC	M23	PWR	
VCC	M25	PWR	
VCC	M29	PWR	
VCC	M31	PWR	
VCC	M33	PWR	
VCC	N11	PWR	
VCC	N33	PWR	
VCC	R11	PWR	
VCC	R33	PWR	
VCC	T11	PWR	
VCC	T33	PWR	
VCC	W11	PWR	
VCC_SENSE	AR9	Analog	
VCCPLL	U33	PWR	
VCCPLL	V33	PWR	
VCCPLL	W33	PWR	
VCCPWRGOOD	AR7	Asynch	I
VDDPWRGOOD	AA6	Asynch	I
VDDQ	A14	PWR	
VDDQ	A19	PWR	
VDDQ	A24	PWR	
VDDQ	A29	PWR	
VDDQ	A9	PWR	
VDDQ	B12	PWR	
VDDQ	B17	PWR	
VDDQ	B22	PWR	
VDDQ	B27	PWR	
VDDQ	B32	PWR	
VDDQ	B7	PWR	
VDDQ	C10	PWR	
VDDQ	C15	PWR	
VDDQ	C20	PWR	
VDDQ	C25	PWR	
VDDQ	C30	PWR	
VDDQ	D13	PWR	
VDDQ	D18	PWR	
VDDQ	D23	PWR	
VDDQ	D28	PWR	
VDDQ	E11	PWR	
VDDQ	E16	PWR	
VDDQ	E21	PWR	
VDDQ	E26	PWR	
VDDQ	E31	PWR	
VDDQ	F14	PWR	
VDDQ	F19	PWR	

**Table 4-1. Land Listing by Land Name  
(Sheet 22 of 29)**

Land Name	Land No.	Buffer Type	Direction
VDDQ	F24	PWR	
VDDQ	G17	PWR	
VDDQ	G22	PWR	
VDDQ	G27	PWR	
VDDQ	H15	PWR	
VDDQ	H20	PWR	
VDDQ	H25	PWR	
VDDQ	J18	PWR	
VDDQ	J23	PWR	
VDDQ	J28	PWR	
VDDQ	K16	PWR	
VDDQ	K21	PWR	
VDDQ	K26	PWR	
VDDQ	L14	PWR	
VDDQ	L19	PWR	
VDDQ	L24	PWR	
VDDQ	M17	PWR	
VDDQ	M27	PWR	
VID[0]/MSID[0]	AL10	CMOS	I/O
VID[1]/MSID[1]	AL9	CMOS	I/O
VID[2]/MSID[2]	AN9	CMOS	I/O
VID[3]/CSC[0]	AM10	CMOS	I/O
VID[4]/CSC[1]	AN10	CMOS	I/O
VID[5]/CSC[2]	AP9	CMOS	I/O
VID[6]	AP8	CMOS	O
VID[7]	AN8	CMOS	O
VSS	A35	GND	
VSS	A39	GND	
VSS	A4	GND	
VSS	A41	GND	
VSS	A6	GND	
VSS	AA3	GND	
VSS	AA34	GND	
VSS	AA38	GND	
VSS	AA39	GND	
VSS	AA9	GND	
VSS	AB37	GND	
VSS	AB4	GND	
VSS	AB40	GND	
VSS	AB42	GND	
VSS	AB7	GND	
VSS	AC2	GND	
VSS	AC36	GND	
VSS	AC5	GND	
VSS	AC7	GND	
VSS	AC9	GND	
VSS	AD11	GND	
VSS	AD33	GND	



**Table 4-1. Land Listing by Land Name  
(Sheet 23 of 29)**

Land Name	Land No.	Buffer Type	Direction
VSS	AD37	GND	
VSS	AD41	GND	
VSS	AD43	GND	
VSS	AE2	GND	
VSS	AE39	GND	
VSS	AE7	GND	
VSS	AF35	GND	
VSS	AF38	GND	
VSS	AF41	GND	
VSS	AF5	GND	
VSS	AG11	GND	
VSS	AG3	GND	
VSS	AG33	GND	
VSS	AG43	GND	
VSS	AG9	GND	
VSS	AH1	GND	
VSS	AH34	GND	
VSS	AH37	GND	
VSS	AH39	GND	
VSS	AH7	GND	
VSS	AJ34	GND	
VSS	AJ36	GND	
VSS	AJ41	GND	
VSS	AJ5	GND	
VSS	AK10	GND	
VSS	AK14	GND	
VSS	AK17	GND	
VSS	AK20	GND	
VSS	AK22	GND	
VSS	AK23	GND	
VSS	AK26	GND	
VSS	AK29	GND	
VSS	AK3	GND	
VSS	AK32	GND	
VSS	AK34	GND	
VSS	AK39	GND	
VSS	AK43	GND	
VSS	AK9	GND	
VSS	AL1	GND	
VSS	AL11	GND	
VSS	AL14	GND	
VSS	AL17	GND	
VSS	AL2	GND	
VSS	AL20	GND	
VSS	AL22	GND	
VSS	AL23	GND	
VSS	AL26	GND	
VSS	AL29	GND	

**Table 4-1. Land Listing by Land Name  
(Sheet 24 of 29)**

Land Name	Land No.	Buffer Type	Direction
VSS	AL32	GND	
VSS	AL35	GND	
VSS	AL36	GND	
VSS	AL37	GND	
VSS	AL42	GND	
VSS	AL7	GND	
VSS	AM11	GND	
VSS	AM14	GND	
VSS	AM17	GND	
VSS	AM20	GND	
VSS	AM22	GND	
VSS	AM23	GND	
VSS	AM26	GND	
VSS	AM29	GND	
VSS	AM32	GND	
VSS	AM35	GND	
VSS	AM37	GND	
VSS	AM39	GND	
VSS	AM5	GND	
VSS	AM9	GND	
VSS	AN11	GND	
VSS	AN14	GND	
VSS	AN17	GND	
VSS	AN20	GND	
VSS	AN22	GND	
VSS	AN23	GND	
VSS	AN26	GND	
VSS	AN29	GND	
VSS	AN3	GND	
VSS	AN32	GND	
VSS	AN35	GND	
VSS	AN37	GND	
VSS	AN41	GND	
VSS	AN7	GND	
VSS	AP1	GND	
VSS	AP10	GND	
VSS	AP11	GND	
VSS	AP14	GND	
VSS	AP17	GND	
VSS	AP20	GND	
VSS	AP22	GND	
VSS	AP23	GND	
VSS	AP26	GND	
VSS	AP29	GND	
VSS	AP32	GND	
VSS	AP35	GND	
VSS	AP36	GND	
VSS	AP37	GND	



**Table 4-1. Land Listing by Land Name  
(Sheet 25 of 29)**

Land Name	Land No.	Buffer Type	Direction
VSS	AP43	GND	
VSS	AP5	GND	
VSS	AP6	GND	
VSS	AR11	GND	
VSS	AR14	GND	
VSS	AR17	GND	
VSS	AR2	GND	
VSS	AR20	GND	
VSS	AR22	GND	
VSS	AR23	GND	
VSS	AR26	GND	
VSS	AR29	GND	
VSS	AR3	GND	
VSS	AR32	GND	
VSS	AR35	GND	
VSS	AR39	GND	
VSS	AT11	GND	
VSS	AT14	GND	
VSS	AT17	GND	
VSS	AT20	GND	
VSS	AT22	GND	
VSS	AT23	GND	
VSS	AT26	GND	
VSS	AT29	GND	
VSS	AT32	GND	
VSS	AT35	GND	
VSS	AT38	GND	
VSS	AT41	GND	
VSS	AT7	GND	
VSS	AT8	GND	
VSS	AU1	GND	
VSS	AU11	GND	
VSS	AU14	GND	
VSS	AU17	GND	
VSS	AU20	GND	
VSS	AU22	GND	
VSS	AU23	GND	
VSS	AU26	GND	
VSS	AU29	GND	
VSS	AU32	GND	
VSS	AU35	GND	
VSS	AU36	GND	
VSS	AU43	GND	
VSS	AU5	GND	
VSS	AV11	GND	
VSS	AV14	GND	
VSS	AV17	GND	
VSS	AV20	GND	

**Table 4-1. Land Listing by Land Name  
(Sheet 26 of 29)**

Land Name	Land No.	Buffer Type	Direction
VSS	AV22	GND	
VSS	AV23	GND	
VSS	AV26	GND	
VSS	AV29	GND	
VSS	AV32	GND	
VSS	AV39	GND	
VSS	AV4	GND	
VSS	AV41	GND	
VSS	AW1	GND	
VSS	AW11	GND	
VSS	AW14	GND	
VSS	AW17	GND	
VSS	AW20	GND	
VSS	AW22	GND	
VSS	AW23	GND	
VSS	AW26	GND	
VSS	AW29	GND	
VSS	AW32	GND	
VSS	AW35	GND	
VSS	AW6	GND	
VSS	AW8	GND	
VSS	AY11	GND	
VSS	AY14	GND	
VSS	AY17	GND	
VSS	AY2	GND	
VSS	AY20	GND	
VSS	AY22	GND	
VSS	AY23	GND	
VSS	AY26	GND	
VSS	AY29	GND	
VSS	AY32	GND	
VSS	AY37	GND	
VSS	AY42	GND	
VSS	AY7	GND	
VSS	B2	GND	
VSS	B37	GND	
VSS	B42	GND	
VSS	BA11	GND	
VSS	BA14	GND	
VSS	BA17	GND	
VSS	BA20	GND	
VSS	BA26	GND	
VSS	BA29	GND	
VSS	BA3	GND	
VSS	BA35	GND	
VSS	BA39	GND	
VSS	BA5	GND	
VSS	C35	GND	



**Table 4-1. Land Listing by Land Name  
(Sheet 27 of 29)**

Land Name	Land No.	Buffer Type	Direction
VSS	C40	GND	
VSS	C43	GND	
VSS	C5	GND	
VSS	D3	GND	
VSS	D33	GND	
VSS	D38	GND	
VSS	D43	GND	
VSS	D8	GND	
VSS	E1	GND	
VSS	E36	GND	
VSS	E41	GND	
VSS	E6	GND	
VSS	F29	GND	
VSS	F34	GND	
VSS	F39	GND	
VSS	F4	GND	
VSS	F9	GND	
VSS	G12	GND	
VSS	G2	GND	
VSS	G32	GND	
VSS	G37	GND	
VSS	G42	GND	
VSS	G7	GND	
VSS	H10	GND	
VSS	H30	GND	
VSS	H35	GND	
VSS	H40	GND	
VSS	H5	GND	
VSS	J13	GND	
VSS	J3	GND	
VSS	J33	GND	
VSS	J38	GND	
VSS	J43	GND	
VSS	J8	GND	
VSS	K1	GND	
VSS	K11	GND	
VSS	K31	GND	
VSS	K36	GND	
VSS	K41	GND	
VSS	K6	GND	
VSS	L29	GND	
VSS	L34	GND	
VSS	L39	GND	
VSS	L4	GND	
VSS	L9	GND	
VSS	M12	GND	
VSS	M14	GND	
VSS	M16	GND	

**Table 4-1. Land Listing by Land Name  
(Sheet 28 of 29)**

Land Name	Land No.	Buffer Type	Direction
VSS	M18	GND	
VSS	M2	GND	
VSS	M20	GND	
VSS	M22	GND	
VSS	M24	GND	
VSS	M26	GND	
VSS	M28	GND	
VSS	M30	GND	
VSS	M32	GND	
VSS	M37	GND	
VSS	M42	GND	
VSS	M7	GND	
VSS	N10	GND	
VSS	N35	GND	
VSS	N40	GND	
VSS	N5	GND	
VSS	P11	GND	
VSS	P3	GND	
VSS	P33	GND	
VSS	P38	GND	
VSS	P43	GND	
VSS	P8	GND	
VSS	R1	GND	
VSS	R36	GND	
VSS	R41	GND	
VSS	R6	GND	
VSS	T34	GND	
VSS	T39	GND	
VSS	T4	GND	
VSS	T9	GND	
VSS	U2	GND	
VSS	U37	GND	
VSS	U42	GND	
VSS	U7	GND	
VSS	V10	GND	
VSS	V35	GND	
VSS	V40	GND	
VSS	V5	GND	
VSS	W3	GND	
VSS	W38	GND	
VSS	W43	GND	
VSS	W8	GND	
VSS	Y1	GND	
VSS	Y11	GND	
VSS	Y33	GND	
VSS	Y36	GND	
VSS	Y41	GND	
VSS	Y6	GND	



**Table 4-1. Land Listing by Land Name  
(Sheet 29 of 29)**

Land Name	Land No.	Buffer Type	Direction
VSS_SENSE	AR8	Analog	
VSS_SENSE_VTT	AE37	Analog	
VTT_SENSE	AE36	Analog	
VTT_VID2	AV3	CMOS	O
VTT_VID3	AF7	CMOS	O
VTT_VID4	AV6	CMOS	O
VTTA	AD10	PWR	
VTTA	AE10	PWR	
VTTA	AE11	PWR	
VTTA	AE33	PWR	
VTTA	AF11	PWR	
VTTA	AF33	PWR	
VTTA	AF34	PWR	
VTTA	AG34	PWR	
VTTD	AA10	PWR	
VTTD	AA11	PWR	
VTTD	AA33	PWR	
VTTD	AB10	PWR	
VTTD	AB11	PWR	
VTTD	AB33	PWR	
VTTD	AB34	PWR	
VTTD	AB8	PWR	
VTTD	AB9	PWR	
VTTD	AC10	PWR	
VTTD	AC11	PWR	
VTTD	AC33	PWR	
VTTD	AC34	PWR	
VTTD	AC35	PWR	
VTTD	AD34	PWR	
VTTD	AD35	PWR	
VTTD	AD36	PWR	
VTTD	AD9	PWR	
VTTD	AE34	PWR	
VTTD	AE35	PWR	
VTTD	AE8	PWR	
VTTD	AE9	PWR	
VTTD	AF36	PWR	
VTTD	AF37	PWR	
VTTD	AF8	PWR	
VTTD	AF9	PWR	
VTTPWGOOD	AB35	Asynch	I



**Table 4-2. Land Listing by Land Number  
(Sheet 1 of 29)**

Land No.	Pin Name	Buffer Type	Direction
A4	VSS	GND	
A5	BPM#[1]	GTL	I/O
A6	VSS	GND	
A7	DDR0_CS#[5]	CMOS	O
A8	DDR1_CS#[1]	CMOS	O
A9	VDDQ	PWR	
A10	DDR0_MA[13]	CMOS	O
A14	VDDQ	PWR	
A15	DDR0_RAS#	CMOS	O
A16	DDR0_BA[1]	CMOS	O
A17	DDR2_BA[0]	CMOS	O
A18	DDR2_MA[0]	CMOS	O
A19	VDDQ	PWR	
A20	DDR0_MA[0]	CMOS	O
A24	VDDQ	PWR	
A25	DDR0_MA[7]	CMOS	O
A26	DDR0_MA[11]	CMOS	O
A27	RSVD		
A28	DDR0_MA[14]	CMOS	O
A29	VDDQ	PWR	
A30	DDR0_CKE[1]	CMOS	O
A31	RSVD		
A35	VSS	GND	
A36	RSVD		
A37	RSVD		
A38	DDR0_DQ[26]	CMOS	I/O
A39	VSS	GND	
A40	RSVD		
A41	VSS	GND	
B2	VSS	GND	
B3	BPM#[0]	GTL	I/O
B4	BPM#[3]	GTL	I/O
B5	DDR0_DQ[32]	CMOS	I/O
B6	DDR0_DQ[36]	CMOS	I/O
B7	VDDQ	PWR	
B8	RSVD		
B9	RSVD		
B10	DDR0_CS#[1]	CMOS	O
B11	DDR0_ODT[2]	CMOS	O
B12	VDDQ	PWR	
B13	DDR0_WE#	CMOS	O
B14	DDR1_MA[13]	CMOS	O
B15	DDR0_CS#[4]	CMOS	O
B16	DDR0_BA[0]	CMOS	O
B17	VDDQ	PWR	
B18	RSVD		
B19	DDR0_MA[10]	CMOS	O
B20	RSVD		

**Table 4-2. Land Listing by Land Number  
(Sheet 2 of 29)**

Land No.	Pin Name	Buffer Type	Direction
B21	DDR0_MA[1]	CMOS	O
B22	VDDQ	PWR	
B23	DDR0_MA[4]	CMOS	O
B24	DDR0_MA[5]	CMOS	O
B25	DDR0_MA[8]	CMOS	O
B26	DDR0_MA[12]	CMOS	O
B27	VDDQ	PWR	
B28	RSVD		
B29	DDR0_MA[15]	CMOS	O
B30	DDR0_CKE[2]	CMOS	O
B31	DDR0_CKE[3]	CMOS	O
B32	VDDQ	PWR	
B33	RSVD		
B34	RSVD		
B35	RSVD		
B36	RSVD		
B37	VSS	GND	
B38	DDR0_DQ[31]	CMOS	I/O
B39	DDR0_DQS_P[3]	CMOS	I/O
B40	DDR0_DQS_N[3]	CMOS	I/O
B41	PRDY#	GTL	O
B42	VSS	GND	
BA3	VSS	GND	
BA4	RSVD		
BA5	VSS	GND	
BA6	RSVD		
BA7	RSVD		
BA8	RSVD		
BA9	VCC	PWR	
BA10	VCC	PWR	
BA11	VSS	GND	
BA12	VCC	PWR	
BA13	VCC	PWR	
BA14	VSS	GND	
BA15	VCC	PWR	
BA16	VCC	PWR	
BA17	VSS	GND	
BA18	VCC	PWR	
BA19	VCC	PWR	
BA20	VSS	GND	
BA24	VCC	PWR	
BA25	VCC	PWR	
BA26	VSS	GND	
BA27	VCC	PWR	
BA28	VCC	PWR	
BA29	VSS	GND	
BA30	VCC	PWR	
BA35	VSS	GND	



**Table 4-2. Land Listing by Land Number  
(Sheet 3 of 29)**

Land No.	Pin Name	Buffer Type	Direction
BA36	QPI_DRX_DP[4]	QPI	I
BA37	QPI_DRX_DN[4]	QPI	I
BA38	QPI_DRX_DP[6]	QPI	I
BA39	VSS	GND	
BA40	RSVD		
C2	BPM#[2]	GTL	I/O
C3	BPM#[5]	GTL	I/O
C4	DDR0_DQ[33]	CMOS	I/O
C5	VSS	GND	
C6	DDR0_DQ[37]	CMOS	I/O
C7	DDR0_ODT[3]	CMOS	O
C8	DDR1_ODT[1]	CMOS	O
C9	DDR0_ODT[1]	CMOS	O
C10	VDDQ	PWR	
C11	RSVD		
C12	DDR0_CAS#	CMOS	O
C13	RSVD		
C14	RSVD		
C15	VDDQ	PWR	
C16	DDR2_WE#	CMOS	O
C17	DDR1_CS#[4]	CMOS	O
C18	DDR1_BA[0]	CMOS	O
C19	DDR0_CLK_N[1]	CLOCK	O
C20	VDDQ	PWR	
C21	DDR1_CLK_P[0]	CLOCK	O
C22	RSVD		
C23	DDR0_MA[2]	CMOS	O
C24	DDR0_MA[6]	CMOS	O
C25	VDDQ	PWR	
C26	DDR0_MA[9]	CMOS	O
C27	DDR1_CKE[3]	CMOS	O
C28	DDR0_BA[2]	CMOS	O
C29	DDR0_CKE[0]	CMOS	O
C30	VDDQ	PWR	
C31	RSVD		
C32	RSVD		
C33	RSVD		
C34	RSVD		
C35	VSS	GND	
C36	RSVD		
C37	RSVD		
C38	DDR0_DQ[30]	CMOS	I/O
C39	RSVD		
C40	VSS	GND	
C41	DDR0_DQ[25]	CMOS	I/O
C42	PREQ#	GTL	I
C43	VSS	GND	
D1	BPM#[4]	GTL	I/O

**Table 4-2. Land Listing by Land Number  
(Sheet 4 of 29)**

Land No.	Pin Name	Buffer Type	Direction
D2	BPM#[6]	GTL	I/O
D3	VSS	GND	
D4	RSVD		
D5	RSVD		
D6	DDR1_DQ[38]	CMOS	I/O
D7	DDR1_DQS_N[4]	CMOS	I/O
D8	VSS	GND	
D9	DDR2_CS#[5]	CMOS	O
D10	DDR2_ODT[3]	CMOS	O
D11	DDR1_ODT[0]	CMOS	O
D12	DDR1_CS#[0]	CMOS	O
D13	VDDQ	PWR	
D14	DDR1_ODT[2]	CMOS	O
D15	DDR2_ODT[2]	CMOS	O
D16	RSVD		
D17	DDR2_RAS#	CMOS	O
D18	VDDQ	PWR	
D19	DDR0_CLK_P[1]	CLOCK	O
D20	RSVD		
D21	DDR1_CLK_N[0]	CLOCK	O
D22	DDR1_MA[7]	CMOS	O
D23	VDDQ	PWR	
D24	DDR0_MA[3]	CMOS	O
D25	RSVD		
D26	DDR2_CKE[2]	CMOS	O
D27	DDR1_CKE[2]	CMOS	O
D28	VDDQ	PWR	
D29	DDR1_RESET#	CMOS	O
D30	RSVD		
D31	RSVD		
D32	DDR0_RESET#	CMOS	O
D33	VSS	GND	
D34	RSVD		
D35	RSVD		
D36	RSVD		
D37	DDR0_DQ[27]	CMOS	I/O
D38	VSS	GND	
D39	RSVD		
D40	DDR0_DQ[24]	CMOS	I/O
D41	DDR0_DQ[28]	CMOS	I/O
D42	DDR0_DQ[29]	CMOS	I/O
D43	VSS	GND	
E1	VSS	GND	
E2	BPM#[7]	GTL	I/O
E3	DDR0_DQS_P[4]	CMOS	I/O
E4	DDR0_DQS_N[4]	CMOS	I/O
E5	DDR1_DQ[34]	CMOS	I/O
E6	VSS	GND	



**Table 4-2. Land Listing by Land Number  
(Sheet 5 of 29)**

Land No.	Pin Name	Buffer Type	Direction
E7	DDR1_DQS_P[4]	CMOS	I/O
E8	DDR1_DQ[33]	CMOS	I/O
E9	DDR1_DQ[32]	CMOS	I/O
E10	DDR1_CS#[5]	CMOS	O
E11	VDDQ	PWR	
E12	RSVD		
E13	RSVD		
E14	DDR1_CAS#	CMOS	O
E15	RSVD		
E16	VDDQ	PWR	
E17	DDR2_CS#[4]	CMOS	O
E18	DDR0_CLK_N[2]	CLOCK	O
E19	DDR0_CLK_N[3]	CLOCK	O
E20	DDR0_CLK_P[3]	CLOCK	O
E21	VDDQ	PWR	
E22	DDR1_MA[8]	CMOS	O
E23	DDR1_MA[11]	CMOS	O
E24	DDR1_MA[12]	CMOS	O
E25	RSVD		
E26	VDDQ	PWR	
E27	DDR1_CKE[1]	CMOS	O
E28	RSVD		
E29	RSVD		
E30	RSVD		
E31	VDDQ	PWR	
E32	DDR2_RESET#	CMOS	O
E33	RSVD		
E34	RSVD		
E35	RSVD		
E36	VSS	GND	
E37	RSVD		
E38	DDR2_DQ[31]	CMOS	I/O
E39	DDR2_DQS_P[3]	CMOS	I/O
E40	DDR2_DQS_N[3]	CMOS	I/O
E41	VSS	GND	
E42	DDR0_DQ[18]	CMOS	I/O
E43	DDR0_DQ[19]	CMOS	I/O
F1	DDR0_DQ[34]	CMOS	I/O
F2	DDR0_DQ[39]	CMOS	I/O
F3	DDR0_DQ[38]	CMOS	I/O
F4	VSS	GND	
F5	DDR1_DQ[35]	CMOS	I/O
F6	DDR1_DQ[39]	CMOS	I/O
F7	RSVD		
F8	RSVD		
F9	VSS	GND	
F10	DDR1_DQ[36]	CMOS	I/O
F11	DDR1_ODT[3]	CMOS	O

**Table 4-2. Land Listing by Land Number  
(Sheet 6 of 29)**

Land No.	Pin Name	Buffer Type	Direction
F12	DDR0_ODT[0]	CMOS	O
F13	DDR2_ODT[1]	CMOS	O
F14	VDDQ	PWR	
F15	DDR2_MA[13]	CMOS	O
F16	DDR2_CAS#	CMOS	O
F17	DDR2_BA[1]	CMOS	O
F18	DDR0_CLK_P[2]	CLOCK	O
F19	VDDQ	PWR	
F20	DDR2_MA[4]	CMOS	O
F21	RSVD		
F22	DDR1_MA[5]	CMOS	O
F23	RSVD		
F24	VDDQ	PWR	
F25	RSVD		
F26	DDR1_MA[15]	CMOS	O
F27	RSVD		
F28	RSVD		
F29	VSS	GND	
F30	RSVD		
F31	RSVD		
F32	RSVD		
F33	RSVD		
F34	VSS	GND	
F35	RSVD		
F36	RSVD		
F37	RSVD		
F38	DDR2_DQ[30]	CMOS	I/O
F39	VSS	GND	
F40	DDR2_DQ[25]	CMOS	I/O
F41	DDR0_DQS_P[2]	CMOS	I/O
F42	DDR0_DQ[23]	CMOS	I/O
F43	DDR0_DQ[22]	CMOS	I/O
G1	DDR0_DQ[44]	CMOS	I/O
G2	VSS	GND	
G3	DDR0_DQ[35]	CMOS	I/O
G4	DDR1_DQ[42]	CMOS	I/O
G5	DDR1_DQ[46]	CMOS	I/O
G6	DDR1_DQS_N[5]	CMOS	I/O
G7	VSS	GND	
G8	DDR1_DQ[37]	CMOS	I/O
G9	DDR1_DQ[44]	CMOS	I/O
G10	DDR2_DQ[37]	CMOS	I/O
G11	DDR2_DQ[36]	CMOS	I/O
G12	VSS	GND	
G13	DDR1_WE#	CMOS	O
G14	DDR1_RAS#	CMOS	O
G15	DDR0_CS#[0]	CMOS	O
G16	DDR2_CS#[0]	CMOS	O



**Table 4-2. Land Listing by Land Number  
(Sheet 7 of 29)**

Land No.	Pin Name	Buffer Type	Direction
G17	VDDQ	PWR	
G18	DDR2_MA[2]	CMOS	O
G19	DDR1_CLK_P[1]	CLOCK	O
G20	DDR1_CLK_N[1]	CLOCK	O
G21	DDR2_CLK_N[2]	CLOCK	O
G22	VDDQ	PWR	
G23	DDR2_MA[12]	CMOS	O
G24	DDR1_MA[9]	CMOS	O
G25	DDR2_MA[15]	CMOS	O
G26	DDR2_CKE[1]	CMOS	O
G27	VDDQ	PWR	
G28	RSVD		
G29	RSVD		
G30	RSVD		
G31	RSVD		
G32	VSS	GND	
G33	RSVD		
G34	RSVD		
G35	RSVD		
G36	RSVD		
G37	VSS	GND	
G38	RSVD		
G39	DDR2_DQ[29]	CMOS	I/O
G40	DDR2_DQ[24]	CMOS	I/O
G41	DDR0_DQS_N[2]	CMOS	I/O
G42	VSS	GND	
G43	RSVD		
H1	DDR0_DQ[41]	CMOS	I/O
H2	DDR0_DQ[40]	CMOS	I/O
H3	DDR0_DQ[45]	CMOS	I/O
H4	DDR1_DQ[43]	CMOS	I/O
H5	VSS	GND	
H6	DDR1_DQS_P[5]	CMOS	I/O
H7	RSVD		
H8	DDR1_DQ[40]	CMOS	I/O
H9	DDR1_DQ[45]	CMOS	I/O
H10	VSS	GND	
H11	RSVD		
H12	DDR2_DQ[38]	CMOS	I/O
H13	DDR2_DQ[34]	CMOS	I/O
H14	DDR1_MA[10]	CMOS	O
H15	VDDQ	PWR	
H16	RSVD		
H17	DDR2_MA[10]	CMOS	O
H18	DDR1_CLK_P[3]	CLOCK	O
H19	DDR1_CLK_N[3]	CLOCK	O
H20	VDDQ	PWR	
H21	DDR2_CLK_P[2]	CLOCK	O

**Table 4-2. Land Listing by Land Number  
(Sheet 8 of 29)**

Land No.	Pin Name	Buffer Type	Direction
H22	DDR2_MA[9]	CMOS	O
H23	DDR2_MA[11]	CMOS	O
H24	DDR2_MA[14]	CMOS	O
H25	VDDQ	PWR	
H26	DDR1_MA[14]	CMOS	O
H27	DDR1_BA[2]	CMOS	O
H28	DDR1_CKE[0]	CMOS	O
H29	RSVD		
H30	VSS	GND	
H31	RSVD		
H32	RSVD		
H33	DDR1_DQ[24]	CMOS	I/O
H34	DDR1_DQ[29]	CMOS	I/O
H35	VSS	GND	
H36	DDR1_DQ[23]	CMOS	I/O
H37	DDR2_DQ[27]	CMOS	I/O
H38	RSVD		
H39	DDR2_DQ[28]	CMOS	I/O
H40	VSS	GND	
H41	DDR0_DQ[16]	CMOS	I/O
H42	RSVD		
H43	DDR0_DQ[17]	CMOS	I/O
J1	RSVD		
J2	RSVD		
J3	VSS	GND	
J4	DDR1_DQ[52]	CMOS	I/O
J5	DDR1_DQ[47]	CMOS	I/O
J6	DDR1_DQ[41]	CMOS	I/O
J7	RSVD		
J8	VSS	GND	
J9	DDR2_DQS_N[4]	CMOS	I/O
J10	DDR2_DQS_P[4]	CMOS	I/O
J11	RSVD		
J12	DDR2_DQ[33]	CMOS	I/O
J13	VSS	GND	
J14	DDR1_MA[0]	CMOS	O
J15	RSVD		
J16	DDR1_MA[1]	CMOS	O
J17	DDR1_MA[2]	CMOS	O
J18	VDDQ	PWR	
J19	DDR0_CLK_P[0]	CLOCK	O
J20	DDR2_MA[3]	CMOS	O
J21	DDR2_CLK_N[0]	CLOCK	O
J22	DDR2_CLK_P[0]	CLOCK	O
J23	VDDQ	PWR	
J24	DDR2_MA[7]	CMOS	O
J25	RSVD		
J26	DDR2_CKE[0]	CMOS	O



**Table 4-2. Land Listing by Land Number  
(Sheet 9 of 29)**

Land No.	Pin Name	Buffer Type	Direction
J27	DDR1_MA[6]	CMOS	O
J28	VDDQ	PWR	
J29	RSVD		
J30	RSVD		
J31	RSVD		
J32	DDR1_DQ[27]	CMOS	I/O
J33	VSS	GND	
J34	DDR1_DQ[28]	CMOS	I/O
J35	DDR1_DQ[19]	CMOS	I/O
J36	DDR1_DQ[22]	CMOS	I/O
J37	DDR2_DQ[26]	CMOS	I/O
J38	VSS	GND	
J39	DDR2_DQ[19]	CMOS	I/O
J40	DDR2_DQ[18]	CMOS	I/O
J41	DDR0_DQ[21]	CMOS	I/O
J42	DDR0_DQ[20]	CMOS	I/O
J43	VSS	GND	
K1	VSS	GND	
K2	DDR0_DQS_P[5]	CMOS	I/O
K3	DDR0_DQS_N[5]	CMOS	I/O
K4	DDR1_DQ[48]	CMOS	I/O
K5	DDR1_DQ[49]	CMOS	I/O
K6	VSS	GND	
K7	DDR2_DQS_N[5]	CMOS	I/O
K8	RSVD		
K9	RSVD		
K10	DDR2_DQ[41]	CMOS	I/O
K11	VSS	GND	
K12	DDR2_DQ[32]	CMOS	I/O
K13	DDR1_BA[1]	CMOS	O
K14	DDR2_CS#[1]	CMOS	O
K15	RSVD		
K16	VDDQ	PWR	
K17	DDR2_MA[1]	CMOS	O
K18	DDR1_CLK_P[2]	CLOCK	O
K19	DDR0_CLK_N[0]	CLOCK	O
K20	DDR2_CLK_N[1]	CLOCK	O
K21	VDDQ	PWR	
K22	DDR2_MA[6]	CMOS	O
K23	DDR2_MA[5]	CMOS	O
K24	RSVD		
K25	RSVD		
K26	VDDQ	PWR	
K27	RSVD		
K28	DDR1_MA[4]	CMOS	O
K29	RSVD		
K30	DDR1_DQ[31]	CMOS	I/O
K31	VSS	GND	

**Table 4-2. Land Listing by Land Number  
(Sheet 10 of 29)**

Land No.	Pin Name	Buffer Type	Direction
K32	DDR1_DQ[26]	CMOS	I/O
K33	RSVD		
K34	RSVD		
K35	DDR1_DQ[18]	CMOS	I/O
K36	VSS	GND	
K37	RSVD		
K38	DDR2_DQ[23]	CMOS	I/O
K39	DDR2_DQS_N[2]	CMOS	I/O
K40	DDR2_DQS_P[2]	CMOS	I/O
K41	VSS	GND	
K42	DDR0_DQ[10]	CMOS	I/O
K43	DDR0_DQ[11]	CMOS	I/O
L1	DDR0_DQ[42]	CMOS	I/O
L2	DDR0_DQ[47]	CMOS	I/O
L3	DDR0_DQ[46]	CMOS	I/O
L4	VSS	GND	
L5	DDR1_DQS_N[6]	CMOS	I/O
L6	DDR1_DQS_P[6]	CMOS	I/O
L7	DDR2_DQS_P[5]	CMOS	I/O
L8	DDR2_DQ[46]	CMOS	I/O
L9	VSS	GND	
L10	DDR2_DQ[40]	CMOS	I/O
L11	DDR2_DQ[44]	CMOS	I/O
L12	DDR2_DQ[39]	CMOS	I/O
L13	DDR2_DQ[35]	CMOS	I/O
L14	VDDQ	PWR	
L15	RSVD		
L16	DDR2_ODT[0]	CMOS	O
L17	RSVD		
L18	DDR1_CLK_N[2]	CLOCK	O
L19	VDDQ	PWR	
L20	DDR2_CLK_P[1]	CLOCK	O
L21	DDR2_CLK_N[3]	CLOCK	O
L22	DDR2_CLK_P[3]	CLOCK	O
L23	DDR_VREF	Analog	I
L24	VDDQ	PWR	
L25	DDR2_MA[8]	CMOS	O
L26	DDR2_BA[2]	CMOS	O
L27	DDR2_CKE[3]	CMOS	O
L28	DDR1_MA[3]	CMOS	O
L29	VSS	GND	
L30	DDR1_DQS_P[3]	CMOS	I/O
L31	DDR1_DQS_N[3]	CMOS	I/O
L32	DDR1_DQ[30]	CMOS	I/O
L33	DDR1_DQ[25]	CMOS	I/O
L34	VSS	GND	
L35	DDR1_DQS_P[2]	CMOS	I/O
L36	DDR1_DQS_N[2]	CMOS	I/O

**Table 4-2. Land Listing by Land Number  
(Sheet 11 of 29)**

Land No.	Pin Name	Buffer Type	Direction
L37	RSVD		
L38	RSVD		
L39	VSS	GND	
L40	DDR2_DQ[22]	CMOS	I/O
L41	DDR0_DQS_P[1]	CMOS	I/O
L42	DDR0_DQ[15]	CMOS	I/O
L43	DDR0_DQ[14]	CMOS	I/O
M1	DDR0_DQ[43]	CMOS	I/O
M2	VSS	GND	
M3	DDR0_DQ[52]	CMOS	I/O
M4	RSVD		
M5	RSVD		
M6	DDR1_DQ[53]	CMOS	I/O
M7	VSS	GND	
M8	DDR2_DQ[47]	CMOS	I/O
M9	DDR2_DQ[42]	CMOS	I/O
M10	DDR2_DQ[45]	CMOS	I/O
M11	VCC	PWR	
M12	VSS	GND	
M13	VCC	PWR	
M14	VSS	GND	
M15	VCC	PWR	
M16	VSS	GND	
M17	VDDQ	PWR	
M18	VSS	GND	
M19	VCC	PWR	
M20	VSS	GND	
M21	VCC	PWR	
M22	VSS	GND	
M23	VCC	PWR	
M24	VSS	GND	
M25	VCC	PWR	
M26	VSS	GND	
M27	VDDQ	PWR	
M28	VSS	GND	
M29	VCC	PWR	
M30	VSS	GND	
M31	VCC	PWR	
M32	VSS	GND	
M33	VCC	PWR	
M34	DDR1_DQ[17]	CMOS	I/O
M35	DDR1_DQ[16]	CMOS	I/O
M36	DDR1_DQ[21]	CMOS	I/O
M37	VSS	GND	
M38	RSVD		
M39	DDR2_DQ[16]	CMOS	I/O
M40	DDR2_DQ[17]	CMOS	I/O
M41	DDR0_DQS_N[1]	CMOS	I/O

**Table 4-2. Land Listing by Land Number  
(Sheet 12 of 29)**

Land No.	Pin Name	Buffer Type	Direction
M42	VSS	GND	
M43	RSVD		
N1	DDR0_DQ[48]	CMOS	I/O
N2	DDR0_DQ[49]	CMOS	I/O
N3	DDR0_DQ[53]	CMOS	I/O
N4	RSVD		
N5	VSS	GND	
N6	DDR2_DQ[49]	CMOS	I/O
N7	DDR2_DQ[53]	CMOS	I/O
N8	DDR2_DQ[52]	CMOS	I/O
N9	DDR2_DQ[43]	CMOS	I/O
N10	VSS	GND	
N11	VCC	PWR	
N33	VCC	PWR	
N34	DDR1_DQ[20]	CMOS	I/O
N35	VSS	GND	
N36	DDR2_DQ[21]	CMOS	I/O
N37	DDR1_DQ[14]	CMOS	I/O
N38	DDR1_DQ[15]	CMOS	I/O
N39	DDR1_DQ[11]	CMOS	I/O
N40	VSS	GND	
N41	DDR0_DQ[8]	CMOS	I/O
N42	RSVD		
N43	DDR0_DQ[9]	CMOS	I/O
P1	RSVD		
P2	RSVD		
P3	VSS	GND	
P4	RSVD		
P5	DDR2_DQS_N[6]	CMOS	I/O
P6	DDR2_DQS_P[6]	CMOS	I/O
P7	DDR2_DQ[48]	CMOS	I/O
P8	VSS	GND	
P9	DDR2_DQ[50]	CMOS	I/O
P10	DDR2_DQ[51]	CMOS	I/O
P11	VSS	GND	
P33	VSS	GND	
P34	DDR1_DQ[8]	CMOS	I/O
P35	DDR1_DQ[9]	CMOS	I/O
P36	RSVD		
P37	RSVD		
P38	VSS	GND	
P39	DDR1_DQ[10]	CMOS	I/O
P40	DDR2_DQ[20]	CMOS	I/O
P41	DDR0_DQ[13]	CMOS	I/O
P42	DDR0_DQ[12]	CMOS	I/O
P43	VSS	GND	
R1	VSS	GND	
R2	DDR0_DQS_P[6]	CMOS	I/O

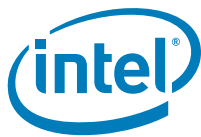

**Table 4-2. Land Listing by Land Number  
(Sheet 13 of 29)**

Land No.	Pin Name	Buffer Type	Direction
R3	DDR0_DQS_N[6]	CMOS	I/O
R4	DDR0_DQ[54]	CMOS	I/O
R5	DDR1_DQ[50]	CMOS	I/O
R6	VSS	GND	
R7	DDR1_DQ[55]	CMOS	I/O
R8	DDR1_DQ[54]	CMOS	I/O
R9	DDR2_DQ[55]	CMOS	I/O
R10	DDR2_DQ[54]	CMOS	I/O
R11	VCC	PWR	
R33	VCC	PWR	
R34	DDR1_DQ[12]	CMOS	I/O
R35	DDR1_DQ[13]	CMOS	I/O
R36	VSS	GND	
R37	DDR1_DQS_N[1]	CMOS	I/O
R38	DDR1_DQS_P[1]	CMOS	I/O
R39	DDR2_DQ[10]	CMOS	I/O
R40	DDR2_DQ[15]	CMOS	I/O
R41	VSS	GND	
R42	DDR0_DQ[3]	CMOS	I/O
R43	DDR0_DQ[2]	CMOS	I/O
T1	DDR0_DQ[50]	CMOS	I/O
T10	DDR2_DQ[58]	CMOS	I/O
T11	VCC	PWR	
T2	DDR0_DQ[51]	CMOS	I/O
T3	DDR0_DQ[55]	CMOS	I/O
T4	VSS	GND	
T5	DDR1_DQ[51]	CMOS	I/O
T6	DDR2_DQ[60]	CMOS	I/O
T7	DDR2_DQ[61]	CMOS	I/O
T8	DDR2_DQS_N[7]	CMOS	I/O
T9	VSS	GND	
T33	VCC	PWR	
T34	VSS	GND	
T35	RSVD		
T36	DDR2_DQ[11]	CMOS	I/O
T37	DDR2_DQS_P[1]	CMOS	I/O
T38	DDR2_DQS_N[1]	CMOS	I/O
T39	VSS	GND	
T40	RSVD		
T41	DDR2_DQ[14]	CMOS	I/O
T42	DDR0_DQ[7]	CMOS	I/O
T43	DDR0_DQS_P[0]	CMOS	I/O
U1	DDR0_DQ[60]	CMOS	I/O
U2	VSS	GND	
U3	DDR0_DQ[61]	CMOS	I/O
U4	DDR0_DQ[56]	CMOS	I/O
U5	DDR2_DQ[56]	CMOS	I/O
U6	DDR2_DQ[57]	CMOS	I/O

**Table 4-2. Land Listing by Land Number  
(Sheet 14 of 29)**

Land No.	Pin Name	Buffer Type	Direction
U7	VSS	GND	
U8	DDR2_DQS_P[7]	CMOS	I/O
U9	DDR2_DQ[63]	CMOS	I/O
U10	DDR2_DQ[59]	CMOS	I/O
U11	RSVD		
U33	VCCPLL	PWR	
U34	DDR2_DQ[4]	CMOS	I/O
U35	RSVD		
U36	DDR2_DQ[3]	CMOS	I/O
U37	VSS	GND	
U38	DDR2_DQ[8]	CMOS	I/O
U39	DDR2_DQ[9]	CMOS	I/O
U40	RSVD		
U41	DDR0_DQ[6]	CMOS	I/O
U42	VSS	GND	
U43	DDR0_DQS_N[0]	CMOS	I/O
V1	DDR0_DQ[57]	CMOS	I/O
V2	RSVD		
V3	RSVD		
V4	DDR0_DQ[62]	CMOS	I/O
V5	VSS	GND	
V6	RSVD		
V7	RSVD		
V8	DDR2_DQ[62]	CMOS	I/O
V9	DDR1_DQ[60]	CMOS	I/O
V10	VSS	GND	
V11	RSVD		
V33	VCCPLL	PWR	
V34	DDR2_DQ[5]	CMOS	I/O
V35	VSS	GND	
V36	DDR2_DQ[2]	CMOS	I/O
V37	DDR2_DQ[6]	CMOS	I/O
V38	DDR2_DQ[7]	CMOS	I/O
V39	DDR2_DQ[13]	CMOS	I/O
V40	VSS	GND	
V41	DDR0_DQ[1]	CMOS	I/O
V42	RSVD		
V43	RSVD		
W1	DDR0_DQS_N[7]	CMOS	I/O
W2	DDR0_DQS_P[7]	CMOS	I/O
W3	VSS	GND	
W4	DDR0_DQ[63]	CMOS	I/O
W5	DDR1_DQ[61]	CMOS	I/O
W6	DDR1_DQ[56]	CMOS	I/O
W7	DDR1_DQ[57]	CMOS	I/O
W8	VSS	GND	
W9	DDR1_DQ[63]	CMOS	I/O
W10	DDR1_DQ[59]	CMOS	I/O

**Table 4-2. Land Listing by Land Number  
(Sheet 15 of 29)**

Land No.	Pin Name	Buffer Type	Direction
W11	VCC	PWR	
W33	VCCPLL	PWR	
W34	DDR2_DQ[0]	CMOS	I/O
W35	DDR2_DQ[1]	CMOS	I/O
W36	DDR2_DQS_N[0]	CMOS	I/O
W37	DDR2_DQS_P[0]	CMOS	I/O
W38	VSS	GND	
W39	DDR2_DQ[12]	CMOS	I/O
W40	DDR0_DQ[4]	CMOS	I/O
W41	DDR0_DQ[0]	CMOS	I/O
W42	DDR0_DQ[5]	CMOS	I/O
W43	VSS	GND	
Y1	VSS	GND	
Y2	DDR0_DQ[58]	CMOS	I/O
Y3	DDR0_DQ[59]	CMOS	I/O
Y4	RSVD		
Y5	RSVD		
Y6	VSS	GND	
Y7	DDR_COMP[1]	Analog	
Y8	DDR1_DQS_P[7]	CMOS	I/O
Y9	DDR1_DQS_N[7]	CMOS	I/O
Y10	DDR1_DQ[58]	CMOS	I/O
Y11	VSS	GND	
Y33	VSS	GND	
Y34	DDR1_DQ[3]	CMOS	I/O
Y35	DDR1_DQ[2]	CMOS	I/O
Y36	VSS	GND	
Y37	DDR1_DQS_N[0]	CMOS	I/O
Y38	DDR1_DQS_P[0]	CMOS	I/O
Y39	DDR1_DQ[7]	CMOS	I/O
Y40	DDR1_DQ[6]	CMOS	I/O
Y41	VSS	GND	
AA3	VSS	GND	
AA4	BCLK_ITP_DN	CMOS	O
AA5	BCLK_ITP_DP	CMOS	O
AA6	VDDPWGOOD	Asynch	I
AA7	DDR1_DQ[62]	CMOS	I/O
AA8	DDR_COMP[0]	Analog	
AA9	VSS	GND	
AA10	VTTD	PWR	
AA11	VTTD	PWR	
AA33	VTTD	PWR	
AA34	VSS	GND	
AA35	DDR1_DQ[4]	CMOS	I/O
AA36	DDR1_DQ[1]	CMOS	I/O
AA37	DDR1_DQ[0]	CMOS	I/O
AA38	VSS	GND	
AA39	VSS	GND	

**Table 4-2. Land Listing by Land Number  
(Sheet 16 of 29)**

Land No.	Pin Name	Buffer Type	Direction
AA40	RSVD		
AA41	RSVD		
AB3	RSVD		
AB4	VSS	GND	
AB5	RSVD		
AB6	RSVD		
AB7	VSS	GND	
AB8	VTTD	PWR	
AB9	VTTD	PWR	
AB10	VTTD	PWR	
AB11	VTTD	PWR	
AB33	VTTD	PWR	
AB34	VTTD	PWR	
AB35	VTTPWGOOD	Asynch	I
AB36	DDR1_DQ[5]	CMOS	I/O
AB37	VSS	GND	
AB38	QPI_DTX_DN[17]	QPI	O
AB39	QPI_DTX_DP[17]	QPI	O
AB40	VSS	GND	
AB41	COMPO	Analog	
AB42	VSS	GND	
AB43	QPI_DTX_DN[13]	QPI	O
AC1	DDR_COMP[2]	Analog	
AC2	VSS	GND	
AC3	RSVD		
AC4	RSVD		
AC5	VSS	GND	
AC6	RSVD		
AC7	VSS	GND	
AC8	RSVD		
AC9	VSS	GND	
AC10	VTTD	PWR	
AC11	VTTD	PWR	
AC33	VTTD	PWR	
AC34	VTTD	PWR	
AC35	VTTD	PWR	
AC36	VSS	GND	
AC37	CAT_ERR#	GTL	I/O
AC38	QPI_DTX_DN[16]	QPI	O
AC39	QPI_DTX_DP[16]	QPI	O
AC40	QPI_DTX_DN[15]	QPI	O
AC41	QPI_DTX_DP[15]	QPI	O
AC42	QPI_DTX_DN[12]	QPI	O
AC43	QPI_DTX_DP[13]	QPI	O
AD1	RSVD		
AD2	RSVD		
AD3	RSVD		
AD4	RSVD		



**Table 4-2. Land Listing by Land Number  
(Sheet 17 of 29)**

Land No.	Pin Name	Buffer Type	Direction
AD5	RSVD		
AD6	RSVD		
AD7	RSVD		
AD8	RSVD		
AD9	VTTD	PWR	
AD10	VTTA	PWR	
AD11	VSS	GND	
AD33	VSS	GND	
AD34	VTTD	PWR	
AD35	VTTD	PWR	
AD36	VTTD	PWR	
AD37	VSS	GND	
AD38	QPI_DTX_DP[18]	QPI	O
AD39	QPI_DTX_DN[14]	QPI	O
AD40	QPI_DTX_DP[14]	QPI	O
AD41	VSS	GND	
AD42	QPI_DTX_DP[12]	QPI	O
AD43	VSS	GND	
AE1	RSVD		
AE2	VSS	GND	
AE3	RSVD		
AE4	RSVD		
AE5	RSVD		
AE6	RSVD		
AE7	VSS	GND	
AE8	VTTD	PWR	
AE9	VTTD	PWR	
AE10	VTTA	PWR	
AE11	VTTA	PWR	
AE33	VTTA	PWR	
AE34	VTTD	PWR	
AE35	VTTD	PWR	
AE36	VTT_SENSE	Analog	
AE37	VSS_SENSE_VTT	Analog	
AE38	QPI_DTX_DN[18]	QPI	O
AE39	VSS	GND	
AE40	QPI_DTX_DP[19]	QPI	O
AE41	QPI_DTX_DN[11]	QPI	O
AE42	QPI_DTX_DP[11]	QPI	O
AE43	QPI_DTX_DN[10]	QPI	O
AF1	RSVD		
AF10	DBR#	Asynch	I
AF11	VTTA	PWR	
AF2	RSVD		
AF3	RSVD		
AF4	RSVD		
AF5	VSS	GND	
AF6	RSVD		

**Table 4-2. Land Listing by Land Number  
(Sheet 18 of 29)**

Land No.	Pin Name	Buffer Type	Direction
AF7	VTT_VID3	CMOS	O
AF8	VTTD	PWR	
AF9	VTTD	PWR	
AF33	VTTA	PWR	
AF34	VTTA	PWR	
AF35	VSS	GND	
AF36	VTTD	PWR	
AF37	VTTD	PWR	
AF38	VSS	GND	
AF39	QPI_DTX_DP[1]	QPI	O
AF40	QPI_DTX_DN[19]	QPI	O
AF41	VSS	GND	
AF42	QPI_CLKTX_DN	QPI	O
AF43	QPI_DTX_DP[10]	QPI	O
AG1	RSVD		
AG2	RSVD		
AG3	VSS	GND	
AG4	RSVD		
AG5	RSVD		
AG6	RSVD		
AG7	RSVD		
AG8	RSVD		
AG9	VSS	GND	
AG10	TMS	TAP	I
AG11	VSS	GND	
AG33	VSS	GND	
AG34	VTTA	PWR	
AG35	PROCHOT#	GTL	I/O
AG36	SKTOCC#	GTL	O
AG37	THERMTRIP#	GTL	O
AG38	QPI_DTX_DP[0]	QPI	O
AG39	QPI_DTX_DN[1]	QPI	O
AG40	QPI_DTX_DP[9]	QPI	O
AG41	QPI_DTX_DN[9]	QPI	O
AG42	QPI_CLKTX_DP	QPI	O
AG43	VSS	GND	
AH1	VSS	GND	
AH2	RSVD		
AH3	RSVD		
AH4	RSVD		
AH5	FC_AH5		
AH6	RSVD		
AH7	VSS	GND	
AH8	RSVD		
AH9	TRST#	TAP	I
AH10	TCK	TAP	I
AH11	VCC	PWR	
AH33	VCC	PWR	





**Table 4-2. Land Listing by Land Number  
(Sheet 19 of 29)**

Land No.	Pin Name	Buffer Type	Direction
AH34	VSS	GND	
AH35	BCLK_DN	CMOS	I
AH36	PECI	Asynch	I/O
AH37	VSS	GND	
AH38	QPI_DTX_DN[0]	QPI	O
AH39	VSS	GND	
AH40	QPI_DTX_DP[4]	QPI	O
AH41	QPI_DTX_DP[6]	QPI	O
AH42	QPI_DTX_DN[6]	QPI	O
AH43	QPI_DTX_DN[8]	QPI	O
AJ1	RSVD		
AJ2	RSVD		
AJ3	RSVD		
AJ4	RSVD		
AJ5	VSS	GND	
AJ6	RSVD		
AJ7	RSVD		
AJ8	RSVD		
AJ9	TDI	TAP	I
AJ10	TDO	TAP	O
AJ11	VCC	PWR	
AJ33	VCC	PWR	
AJ34	VSS	GND	
AJ35	BCLK_DP	CMOS	I
AJ36	VSS	GND	
AJ37	RSVD		
AJ38	QPI_DTX_DP[3]	QPI	O
AJ39	QPI_DTX_DN[3]	QPI	O
AJ40	QPI_DTX_DN[4]	QPI	O
AJ41	VSS	GND	
AJ42	QPI_DTX_DN[7]	QPI	O
AJ43	QPI_DTX_DP[8]	QPI	O
AK1	RSVD		
AK2	RSVD		
AK3	VSS	GND	
AK4	RSVD		
AK5	RSVD		
AK6	RSVD		
AK7	RSVD		
AK8	ISENSE	Analog	I
AK9	VSS	GND	
AK10	VSS	GND	
AK11	VCC	PWR	
AK12	VCC	PWR	
AK13	VCC	PWR	
AK14	VSS	GND	
AK15	VCC	PWR	
AK16	VCC	PWR	

**Table 4-2. Land Listing by Land Number  
(Sheet 20 of 29)**

Land No.	Pin Name	Buffer Type	Direction
AK17	VSS	GND	
AK18	VCC	PWR	
AK19	VCC	PWR	
AK20	VSS	GND	
AK21	VCC	PWR	
AK22	VSS	GND	
AK23	VSS	GND	
AK24	VCC	PWR	
AK25	VCC	PWR	
AK26	VSS	GND	
AK27	VCC	PWR	
AK28	VCC	PWR	
AK29	VSS	GND	
AK30	VCC	PWR	
AK31	VCC	PWR	
AK32	VSS	GND	
AK33	VCC	PWR	
AK34	VSS	GND	
AK35	RSVD		
AK36	RSVD		
AK37	QPI_DTX_DP[2]	QPI	O
AK38	QPI_DTX_DN[2]	QPI	O
AK39	VSS	GND	
AK40	QPI_DTX_DP[5]	QPI	O
AK41	QPI_DTX_DN[5]	QPI	O
AK42	QPI_DTX_DP[7]	QPI	O
AK43	VSS	GND	
AL1	VSS	GND	
AL2	VSS	GND	
AL3	RSVD		
AL4	RSVD		
AL5	RSVD		
AL6	RSVD		
AL7	VSS	GND	
AL8	RSVD		
AL9	VID[1]/MSID[1]	CMOS	I/O
AL10	VID[0]/MSID[0]	CMOS	I/O
AL11	VSS	GND	
AL12	VCC	PWR	
AL13	VCC	PWR	
AL14	VSS	GND	
AL15	VCC	PWR	
AL16	VCC	PWR	
AL17	VSS	GND	
AL18	VCC	PWR	
AL19	VCC	PWR	
AL20	VSS	GND	
AL21	VCC	PWR	



**Table 4-2. Land Listing by Land Number  
(Sheet 21 of 29)**

Land No.	Pin Name	Buffer Type	Direction
AL22	VSS	GND	
AL23	VSS	GND	
AL24	VCC	PWR	
AL25	VCC	PWR	
AL26	VSS	GND	
AL27	VCC	PWR	
AL28	VCC	PWR	
AL29	VSS	GND	
AL30	VCC	PWR	
AL31	VCC	PWR	
AL32	VSS	GND	
AL33	VCC	PWR	
AL34	VCC	PWR	
AL35	VSS	GND	
AL36	VSS	GND	
AL37	VSS	GND	
AL38	RSVD		
AL39	RESET#	Asynch	I
AL40	RSVD		
AL41	RSVD		
AL42	VSS	GND	
AL43	QPI_CMP[0]	Analog	
AM1	RSVD		
AM2	RSVD		
AM3	RSVD		
AM4	RSVD		
AM5	VSS	GND	
AM6	RSVD		
AM7	RSVD		
AM8	RSVD		
AM9	VSS	GND	
AM10	VID[3]/CSC[0]	CMOS	I/O
AM11	VSS	GND	
AM12	VCC	PWR	
AM13	VCC	PWR	
AM14	VSS	GND	
AM15	VCC	PWR	
AM16	VCC	PWR	
AM17	VSS	GND	
AM18	VCC	PWR	
AM19	VCC	PWR	
AM20	VSS	GND	
AM21	VCC	PWR	
AM22	VSS	GND	
AM23	VSS	GND	
AM24	VCC	PWR	
AM25	VCC	PWR	
AM26	VSS	GND	

**Table 4-2. Land Listing by Land Number  
(Sheet 22 of 29)**

Land No.	Pin Name	Buffer Type	Direction
AM27	VCC	PWR	
AM28	VCC	PWR	
AM29	VSS	GND	
AM30	VCC	PWR	
AM31	VCC	PWR	
AM32	VSS	GND	
AM33	VCC	PWR	
AM34	VCC	PWR	
AM35	VSS	GND	
AM36	RSVD		
AM37	VSS	GND	
AM38	RSVD		
AM39	VSS	GND	
AM40	QPI_DRX_DN[15]	QPI	I
AM41	QPI_DRX_DN[16]	QPI	I
AM42	QPI_DRX_DP[16]	QPI	I
AM43	QPI_DRX_DN[14]	QPI	I
AN1	RSVD		
AN2	RSVD		
AN3	VSS	GND	
AN4	RSVD		
AN5	RSVD		
AN6	RSVD		
AN7	VSS	GND	
AN8	VID[7]	CMOS	O
AN9	VID[2]/MSID[2]	CMOS	I/O
AN10	VID[4]/CSC[1]	CMOS	I/O
AN11	VSS	GND	
AN12	VCC	PWR	
AN13	VCC	PWR	
AN14	VSS	GND	
AN15	VCC	PWR	
AN16	VCC	PWR	
AN17	VSS	GND	
AN18	VCC	PWR	
AN19	VCC	PWR	
AN20	VSS	GND	
AN21	VCC	PWR	
AN22	VSS	GND	
AN23	VSS	GND	
AN24	VCC	PWR	
AN25	VCC	PWR	
AN26	VSS	GND	
AN27	VCC	PWR	
AN28	VCC	PWR	
AN29	VSS	GND	
AN30	VCC	PWR	
AN31	VCC	PWR	



**Table 4-2. Land Listing by Land Number (Sheet 23 of 29)**

Land No.	Pin Name	Buffer Type	Direction
AN32	VSS	GND	
AN33	VCC	PWR	
AN34	VCC	PWR	
AN35	VSS	GND	
AN36	RSVD		
AN37	VSS	GND	
AN38	RSVD		
AN39	QPI_DRX_DP[18]	QPI	I
AN40	QPI_DRX_DP[15]	QPI	I
AN41	VSS	GND	
AN42	QPI_DRX_DN[13]	QPI	I
AN43	QPI_DRX_DP[14]	QPI	I
AP1	VSS	GND	
AP2	RSVD		
AP3	RSVD		
AP4	RSVD		
AP5	VSS	GND	
AP6	VSS	GND	
AP7	PSI#	CMOS	O
AP8	VID[6]	CMOS	O
AP9	VID[5]/CSC[2]	CMOS	I/O
AP10	VSS	GND	
AP11	VSS	GND	
AP12	VCC	PWR	
AP13	VCC	PWR	
AP14	VSS	GND	
AP15	VCC	PWR	
AP16	VCC	PWR	
AP17	VSS	GND	
AP18	VCC	PWR	
AP19	VCC	PWR	
AP20	VSS	GND	
AP21	VCC	PWR	
AP22	VSS	GND	
AP23	VSS	GND	
AP24	VCC	PWR	
AP25	VCC	PWR	
AP26	VSS	GND	
AP27	VCC	PWR	
AP28	VCC	PWR	
AP29	VSS	GND	
AP30	VCC	PWR	
AP31	VCC	PWR	
AP32	VSS	GND	
AP33	VCC	PWR	
AP34	VCC	PWR	
AP35	VSS	GND	
AP36	VSS	GND	

**Table 4-2. Land Listing by Land Number (Sheet 24 of 29)**

Land No.	Pin Name	Buffer Type	Direction
AP37	VSS	GND	
AP38	QPI_DRX_DP[19]	QPI	I
AP39	QPI_DRX_DN[18]	QPI	I
AP40	QPI_DRX_DN[17]	QPI	I
AP41	QPI_DRX_DP[17]	QPI	I
AP42	QPI_DRX_DP[13]	QPI	I
AP43	VSS	GND	
AR1	RSVD		
AR2	VSS	GND	
AR3	VSS	GND	
AR4	RSVD		
AR5	RSVD		
AR6	RSVD		
AR7	VCCPWRGOOD	Asynch	I
AR8	VSS_SENSE	Analog	
AR9	VCC_SENSE	Analog	
AR10	VCC	PWR	
AR11	VSS	GND	
AR12	VCC	PWR	
AR13	VCC	PWR	
AR14	VSS	GND	
AR15	VCC	PWR	
AR16	VCC	PWR	
AR17	VSS	GND	
AR18	VCC	PWR	
AR19	VCC	PWR	
AR20	VSS	GND	
AR21	VCC	PWR	
AR22	VSS	GND	
AR23	VSS	GND	
AR24	VCC	PWR	
AR25	VCC	PWR	
AR26	VSS	GND	
AR27	VCC	PWR	
AR28	VCC	PWR	
AR29	VSS	GND	
AR30	VCC	PWR	
AR31	VCC	PWR	
AR32	VSS	GND	
AR33	VCC	PWR	
AR34	VCC	PWR	
AR35	VSS	GND	
AR36	RSVD		
AR37	RSVD		
AR38	QPI_DRX_DN[19]	QPI	I
AR39	VSS	GND	
AR40	QPI_DRX_DN[12]	QPI	I
AR41	QPI_CLKRX_DP	QPI	I



**Table 4-2. Land Listing by Land Number  
(Sheet 25 of 29)**

Land No.	Pin Name	Buffer Type	Direction
AR42	QPI_CLKRX_DN	QPI	I
AR43	QPI_DRX_DN[11]	QPI	I
AT1	RSVD		
AT2	RSVD		
AT3	RSVD		
AT4	RSVD		
AT5	RSVD		
AT6	RSVD		
AT7	VSS	GND	
AT8	VSS	GND	
AT9	VCC	PWR	
AT10	VCC	PWR	
AT11	VSS	GND	
AT12	VCC	PWR	
AT13	VCC	PWR	
AT14	VSS	GND	
AT15	VCC	PWR	
AT16	VCC	PWR	
AT17	VSS	GND	
AT18	VCC	PWR	
AT19	VCC	PWR	
AT20	VSS	GND	
AT21	VCC	PWR	
AT22	VSS	GND	
AT23	VSS	GND	
AT24	VCC	PWR	
AT25	VCC	PWR	
AT26	VSS	GND	
AT27	VCC	PWR	
AT28	VCC	PWR	
AT29	VSS	GND	
AT30	VCC	PWR	
AT31	VCC	PWR	
AT32	VSS	GND	
AT33	VCC	PWR	
AT34	VCC	PWR	
AT35	VSS	GND	
AT36	RSVD		
AT37	QPI_DRX_DP[0]	QPI	I
AT38	VSS	GND	
AT39	QPI_DRX_DN[7]	QPI	I
AT40	QPI_DRX_DP[12]	QPI	I
AT41	VSS	GND	
AT42	QPI_DRX_DN[10]	QPI	I
AT43	QPI_DRX_DP[11]	QPI	I
AU1	VSS	GND	
AU2	RSVD		
AU3	RSVD		

**Table 4-2. Land Listing by Land Number  
(Sheet 26 of 29)**

Land No.	Pin Name	Buffer Type	Direction
AU4	RSVD		
AU5	VSS	GND	
AU6	RSVD		
AU7	RSVD		
AU8	RSVD		
AU9	VCC	PWR	
AU10	VCC	PWR	
AU11	VSS	GND	
AU12	VCC	PWR	
AU13	VCC	PWR	
AU14	VSS	GND	
AU15	VCC	PWR	
AU16	VCC	PWR	
AU17	VSS	GND	
AU18	VCC	PWR	
AU19	VCC	PWR	
AU20	VSS	GND	
AU21	VCC	PWR	
AU22	VSS	GND	
AU23	VSS	GND	
AU24	VCC	PWR	
AU25	VCC	PWR	
AU26	VSS	GND	
AU27	VCC	PWR	
AU28	VCC	PWR	
AU29	VSS	GND	
AU30	VCC	PWR	
AU31	VCC	PWR	
AU32	VSS	GND	
AU33	VCC	PWR	
AU34	VCC	PWR	
AU35	VSS	GND	
AU36	VSS	GND	
AU37	QPI_DRX_DN[0]	QPI	I
AU38	QPI_DRX_DP[1]	QPI	I
AU39	QPI_DRX_DP[7]	QPI	I
AU40	QPI_DRX_DP[9]	QPI	I
AU41	QPI_DRX_DN[9]	QPI	I
AU42	QPI_DRX_DP[10]	QPI	I
AU43	VSS	GND	
AV1	RSVD		
AV2	RSVD		
AV3	VTT_VID2	CMOS	O
AV4	VSS	GND	
AV5	RSVD		
AV6	VTT_VID4	CMOS	O
AV7	RSVD		
AV8	RSVD		



**Table 4-2. Land Listing by Land Number  
(Sheet 27 of 29)**

Land No.	Pin Name	Buffer Type	Direction
AV9	VCC	PWR	
AV10	VCC	PWR	
AV11	VSS	GND	
AV12	VCC	PWR	
AV13	VCC	PWR	
AV14	VSS	GND	
AV15	VCC	PWR	
AV16	VCC	PWR	
AV17	VSS	GND	
AV18	VCC	PWR	
AV19	VCC	PWR	
AV20	VSS	GND	
AV21	VCC	PWR	
AV22	VSS	GND	
AV23	VSS	GND	
AV24	VCC	PWR	
AV25	VCC	PWR	
AV26	VSS	GND	
AV27	VCC	PWR	
AV28	VCC	PWR	
AV29	VSS	GND	
AV30	VCC	PWR	
AV31	VCC	PWR	
AV32	VSS	GND	
AV33	VCC	PWR	
AV34	VCC	PWR	
AV35	RSVD		
AV36	QPI_DRX_DP[2]	QPI	I
AV37	QPI_DRX_DN[2]	QPI	I
AV38	QPI_DRX_DN[1]	QPI	I
AV39	VSS	GND	
AV40	QPI_DRX_DN[8]	QPI	I
AV41	VSS	GND	
AV42	RSVD		
AV43	RSVD		
AW1	VSS	GND	
AW2	RSVD		
AW3	RSVD		
AW4	RSVD		
AW5	RSVD		
AW6	VSS	GND	
AW7	RSVD		
AW8	VSS	GND	
AW9	VCC	PWR	
AW10	VCC	PWR	
AW11	VSS	GND	
AW12	VCC	PWR	
AW13	VCC	PWR	

**Table 4-2. Land Listing by Land Number  
(Sheet 28 of 29)**

Land No.	Pin Name	Buffer Type	Direction
AW14	VSS	GND	
AW15	VCC	PWR	
AW16	VCC	PWR	
AW17	VSS	GND	
AW18	VCC	PWR	
AW19	VCC	PWR	
AW20	VSS	GND	
AW21	VCC	PWR	
AW22	VSS	GND	
AW23	VSS	GND	
AW24	VCC	PWR	
AW25	VCC	PWR	
AW26	VSS	GND	
AW27	VCC	PWR	
AW28	VCC	PWR	
AW29	VSS	GND	
AW30	VCC	PWR	
AW31	VCC	PWR	
AW32	VSS	GND	
AW33	VCC	PWR	
AW34	VCC	PWR	
AW35	VSS	GND	
AW36	QPI_DRX_DP[3]	QPI	I
AW37	QPI_DRX_DP[5]	QPI	I
AW38	QPI_DRX_DN[5]	QPI	I
AW39	RSVD		
AW40	QPI_DRX_DP[8]	QPI	I
AW41	RSVD		
AW42	RSVD		
AY2	VSS	GND	
AY3	RSVD		
AY4	RSVD		
AY5	RSVD		
AY6	RSVD		
AY7	VSS	GND	
AY8	RSVD		
AY9	VCC	PWR	
AY10	VCC	PWR	
AY11	VSS	GND	
AY12	VCC	PWR	
AY13	VCC	PWR	
AY14	VSS	GND	
AY15	VCC	PWR	
AY16	VCC	PWR	
AY17	VSS	GND	
AY18	VCC	PWR	
AY19	VCC	PWR	
AY20	VSS	GND	



**Table 4-2. Land Listing by Land Number  
(Sheet 29 of 29)**

Land No.	Pin Name	Buffer Type	Direction
AY21	VCC	PWR	
AY22	VSS	GND	
AY23	VSS	GND	
AY24	VCC	PWR	
AY25	VCC	PWR	
AY26	VSS	GND	
AY27	VCC	PWR	
AY28	VCC	PWR	
AY29	VSS	GND	
AY30	VCC	PWR	
AY31	VCC	PWR	
AY32	VSS	GND	
AY33	VCC	PWR	
AY34	VCC	PWR	
AY35	RSVD		
AY36	QPI_DRX_DN[3]	QPI	I
AY37	VSS	GND	
AY38	QPI_DRX_DN[6]	QPI	I
AY39	RSVD		
AY40	RSVD		
AY41	RSVD		
AY42	VSS	GND	

§

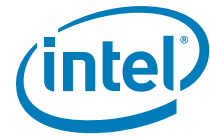

## 5 Signal Descriptions

This chapter provides the processor signal definitions.

**Table 5-1. Signal Definitions (Sheet 1 of 4)**

Name	Type	Description	Notes
BCLK_DN BCLK_DP	I	Differential bus clock input to the processor.	
BCLK_ITP_DN BCLK_ITP_DP	O	Buffered differential bus clock pair to ITP.	
BPM#[7:0]	I/O	BPM#[7:0] are breakpoint and performance monitor signals. They are outputs from the processor that indicate the status of breakpoints and programmable counters used for monitoring processor performance.	
CAT_ERR#	I/O	Indicates that the system has experienced a catastrophic error and cannot continue to operate. The processor will set this for non-recoverable machine check errors and other internal unrecoverable error. Since this is an I/O pin, external agents are allowed to assert this pin which will cause the processor to take a machine check exception.	
COMP0	I	Impedance compensation must be terminated on the system board using a precision resistor.	
QPI_CLKRX_DN QPI_CLKRX_DP	I I	Intel QPI received clock is the input clock that corresponds to the received data.	
QPI_CLKTX_DN QPI_CLKTX_DP	O O	Intel QPI forwarded clock sent with the outbound data.	
QPI_CMP[0]	I	Must be terminated on the system board using a precision resistor.	
QPI_DRX_DN[19:0] QPI_DRX_DP[19:0]	I I	QPI_DRX_DN[19:0] and QPI_DRX_DP[19:0] comprise the differential receive data for the QPI port. The inbound 20 lanes are connected to another component's outbound direction.	
QPI_DTX_DN[19:0] QPI_DTX_DP[19:0]	O O	QPI_DTX_DN[19:0] and QPI_DTX_DP[19:0] comprise the differential transmit data for the QPI port. The outbound 20 lanes are connected to another component's inbound direction.	
DBR#	I	DBR# is used only in systems where no debug port is implemented on the system board. DBR# is used by a debug port interposer so that an in-target probe can drive system reset. If a debug port is implemented in the system, DBR# is a no connect in the system. DBR# is not a processor signal.	
DDR_COMP[2:0]	I	Must be terminated on the system board using precision resistors.	
DDR_VREF	I	Voltage reference for DDR3	
DDR{0/1/2}_BA[2:0]	O	Defines the bank which is the destination for the current Activate, Read, Write, or Precharge command.	1
DDR{0/1/2}_CAS#	O	Column Address Strobe.	1
DDR{0/1/2}_CKE[3:0]	O	Clock Enable.	1
DDR{0/1/2}_CLK_N[2:0] DDR{0/1/2}_CLK_P[2:0]	O	Differential clocks to the DIMM. All command and control signals are valid on the rising edge of clock.	1
DDR{0/1/2}_CS[1:0]# DDR{0/1/2}_CS[5:4]#	O	Each signal selects one rank as the target of the command and address.	1
DDR{0/1/2}_DQ[63:0]	I/O	DDR3 Data bits.	1

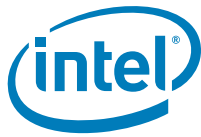

Table 5-1. Signal Definitions (Sheet 2 of 4)

Name	Type	Description	Notes
DDR{0/1/2}_DQS_N[7:0] DDR{0/1/2}_DQS_P[7:0]	I/O	Differential pair, Data Strobe x8. Differential strobes latch data/ECC for each DRAM. Different numbers of strobes are used depending on whether the connected DRAMs are x4 or x8. Driven with edges in center of data, receive edges are aligned with data edges.	1
DDR{0/1/2}_MA[15:0]	O	Selects the Row address for reads and writes, and the column address for activates. Also used to set values for DRAM configuration registers.	1
DDR{0/1/2}_ODT[3:0]	O	Enables various combinations of termination resistance in the target and non-target DIMMs when data is read or written	1
DDR{0/1/2}_RAS#	O	Row Address Strobe.	1
DDR{0/1/2}_RESET#	O	Resets DRAMs. Held low on power up, held high during self refresh; otherwise, controlled by configuration register.	1
DDR{0/1/2}_WE#	O	Write Enable.	1
ISENSE	I	Current sense from VRD11.1.	
PECI	I/O	PECI (Platform Environment Control Interface) is the serial sideband interface to the processor and is used primarily for thermal, power, and error management. Details regarding the Peci electrical specifications, protocols, and functions can be found in the Platform Environment Control Interface Specification.	
PRDY#	O	PRDY# is a processor output used by debug tools to determine processor debug readiness.	
PREQ#	I/O	PREQ# is used by debug tools to request debug operation of the processor.	
PROCHOT#	I/O	PROCHOT# will go active when the processor temperature monitoring sensor detects that the processor has reached its maximum safe operating temperature. This indicates that the processor Thermal Control Circuit has been activated, if enabled. This signal can also be driven to the processor to activate the Thermal Control Circuit. This signal does not have on-die termination and must be terminated on the system board.	
PSI#	O	Processor Power Status Indicator signal. This signal is asserted when maximum possible processor core current consumption is less than 20 A. Assertion of this signal is an indication that the VR controller does not currently need to be able to provide I <sub>CC</sub> above 20 A, and the VR controller can use this information to move to a more efficient operation point. This signal will de-assert at least 3.3 us before the current consumption will exceed 20 A. The minimum PSI# assertion and de-assertion time is 1 BCLK.	
RESET#	I	Asserting the RESET# signal resets the processor to a known state and invalidates its internal caches without writing back any of their contents. Note that some PLL, QPI, and error states are not effected by reset and only VCCPWRGOOD forces them to a known state. For a power-on Reset, RESET# must stay active for at least one millisecond after V <sub>CC</sub> and BCLK have reached their proper specifications. RESET# must not be kept asserted for more than 10 ms while VCCPWRGOOD is asserted. RESET# must be held de-asserted for at least 1 ms before it is asserted again. RESET# must be held asserted before VCCPWRGOOD is asserted. This signal does not have on-die termination and must be terminated on the system board. RESET# is a common clock signal.	
SKTOCC#	O	SKTOCC# (Socket Occupied) will be pulled to ground on the processor package. There is no connection to the processor silicon for this signal. System board designers may use this signal to determine if the processor is present.	
TCK	I	TCK (Test Clock) provides the clock input for the processor Test Bus (also known as the Test Access Port).	





Table 5-1. Signal Definitions (Sheet 3 of 4)

Name	Type	Description	Notes
TDI	I	TDI (Test Data In) transfers serial test data into the processor. TDI provides the serial input needed for JTAG specification support.	
TDO	O	TDO (Test Data Out) transfers serial test data out of the processor. TDO provides the serial output needed for JTAG specification support.	
TESTLOW	I	TESTLOW must be connected to ground through a resistor for proper processor operation.	
THERMTRIP#	O	Assertion of THERMTRIP# (Thermal Trip) indicates the processor junction temperature has reached a level beyond which permanent silicon damage may occur. Measurement of the temperature is accomplished through an internal thermal sensor. Upon assertion of THERMTRIP#, the processor will shut off its internal clocks (thus, halting program execution) in an attempt to reduce the processor junction temperature. To further protect the processor, its core voltage ( $V_{CC}$ ), $V_{TTA}$ , $V_{TTD}$ , and $V_{DDQ}$ must be removed following the assertion of THERMTRIP#. Once activated, THERMTRIP# remains latched until RESET# is asserted. While the assertion of the RESET# signal may de-assert THERMTRIP#, if the processor junction temperature remains at or above the trip level, THERMTRIP# will again be asserted after RESET# is de-asserted.	
TMS	I	TMS (Test Mode Select) is a JTAG specification support signal used by debug tools.	
TRST#	I	TRST# (Test Reset) resets the Test Access Port (TAP) logic. TRST# must be driven low during power on Reset.	
VCC	I	Power for processor core.	
VCC_SENSE VSS_SENSE	O O	VCC_SENSE and VSS_SENSE provide an isolated, low impedance connection to the processor core power and ground. They can be used to sense or measure voltage near the silicon.	
VCCPLL	I	Power for on-die PLL filter.	
VCCPWRGOOD	I	VCCPWRGOOD (Power Good) is a processor input. The processor requires this signal to be a clean indication that BCLK, $V_{CC}$ , $V_{CCPLL}$ , $V_{TTA}$ and $V_{TTD}$ supplies are stable and within their specifications. 'Clean' implies that the signal will remain low (capable of sinking leakage current), without glitches, from the time that the power supplies are turned on until they come within specification. The signal must then transition monotonically to a high state. VCCPWRGOOD can be driven inactive at any time, but BCLK and power must again be stable before a subsequent rising edge of VCCPWRGOOD. In addition, at the time VCCPWRGOOD is asserted RESET# must be active. The PWRGOOD signal must be supplied to the processor. It should be driven high throughout boundary scan operation.	
VDDPWRGOOD	I	VDDPWRGOOD is an input that indicates the $V_{DDQ}$ power supply is good. The processor requires this signal to be a clean indication that the $V_{DDQ}$ power supply is stable and within specifications. "Clean" implies that the signal will remain low (capable of sinking leakage current), without glitches, from the time that the $V_{DDQ}$ supply is turned on until it comes within specification. The signals must then transition monotonically to a high state. The PWRGOOD signal must be supplied to the processor.	

Table 5-1. Signal Definitions (Sheet 4 of 4)

Name	Type	Description	Notes
VID[7:6] VID[5:3]/CSC[2:0] VID[2:0]/MSID[2:0]	I/O	<p>VID[7:0] (Voltage ID) are used to support automatic selection of power supply voltages (<math>V_{CC}</math>). Refer to the <i>Voltage Regulator-Down (VRD) 11.1 Design Guidelines</i> for more information. The voltage supply for these signals must be valid before the VR can supply <math>V_{CC}</math> to the processor. Conversely, the VR output must be disabled until the voltage supply for the VID signals become valid. The VR must supply the voltage that is requested by the signals, or disable itself.</p> <p>VID7 and VID6 should be tied separately to <math>V_{SS}</math> using a 1 k<math>\Omega</math> resistor during reset (This value is latched on the rising edge of VTPWRGOOD).</p> <p>MSID[2:0] — MSID[2:0] is used to indicate to the processor whether the platform supports a particular TDP. A processor will only boot if the MSID[2:0] pins are strapped to the appropriate setting on the platform (see Table 2-2 for MSID encodings). In addition, MSID protects the platform by preventing a higher power processor from booting in a platform designed for lower power processors.</p> <p>CSC[2:0] — Current Sense Configuration bits, for ISENSE gain setting. See <i>Voltage Regulator-Down (VRD) 11.1 Design Guidelines</i> for gain setting information. This value is latched on the rising edge of VTPWRGOOD.</p>	
VTTA	I	Power for the analog portion of the integrated memory controller, QPI, and Shared Cache.	
VTTD	I	Power for the digital portion of the integrated memory controller, QPI, and Shared Cache.	
VTT_VID[4:2]	O	VTT_VID[2:4] ( $V_{TT}$ Voltage ID) are used to support automatic selection of power supply voltages ( $V_{TT}$ ). Refer to the <i>Voltage Regulator-Down (VRD) 11.1 Design Guidelines</i> for more information.	
VTT_SENSE VSS_SENSE_VTT	O O	VTT_SENSE and VSS_SENSE_VTT provide an isolated, low impedance connection to the processor $V_{TT}$ voltage and ground. They can be used to sense or measure voltage near the silicon.	
VTPWRGOOD	I	The processor requires this input signal to be a clean indication that the $V_{TT}$ power supply is stable and within specifications. 'Clean' implies that the signal will remain low (capable of sinking leakage current), without glitches, from the time that the power supplies are turned on until they come within specification. The signal must then transition monotonically to a high state. Note that it is not valid for VTPWRGOOD to be de-asserted while VCCPWRGOOD is asserted.	

**Note:**

1. DDR{0/1/2} refers to DDR3 Channel 0, DDR3 Channel 1, and DDR3 Channel 2.

§



# 6 Thermal Specifications

---

## 6.1 Package Thermal Specifications

The processor requires a thermal solution to maintain temperatures within its operating limits. Any attempt to operate the processor outside these operating limits may result in permanent damage to the processor and potentially other components within the system. Maintaining the proper thermal environment is key to reliable, long-term system operation.

A complete solution includes both component and system level thermal management features. Component level thermal solutions can include active or passive heatsinks attached to the processor integrated heat spreader (IHS).

This chapter provides data necessary for developing a complete thermal solution. For more information on designing a component level thermal solution, refer to the appropriate processor Thermal and Mechanical Design Guidelines (see [Section 1.2](#)).

### 6.1.1 Thermal Specifications

The processor thermal specification uses the on-die Digital Thermal Sensor (DTS) value reported using the PECL interface for all processor temperature measurements. The DTS is a factory calibrated, analog-to-digital thermal sensor. As a result, it will no longer be necessary to measure the processors case temperature. Consequently, there will be no need for a Thermal Profile specification defining the relationship between the processors  $T_{CASE}$  and power dissipation.

**Note:** Unless otherwise specified, the term “DTS” refers to the DTS value returned by from the PECL interface gettemp command.

**Note:** A thermal solution that was verified compliant to the processor case temperature thermal profile at the customer defined boundary conditions is expected to be compliant with this update. No redesign of the thermal solution should be necessary. A fan speed control algorithm that was compliant to the previous thermal requirements is also expected to be compliant with this specification. The fan speed control algorithm can be updated to use the additional information to optimize acoustics.

To allow the optimal operation and long-term reliability of Intel processor-based systems, the processor thermal solution must deliver the specified thermal solution performance in response to the DTS sensor value. The thermal solution performance will be measured using a Thermal Test Vehicle (TTV). See [Table 6-1](#) and [Figure 6-1](#) or [Figure 6-2](#) for the TTV thermal profile. See [Table 6-4](#) for the required thermal solution performance table when DTS values are greater than  $T_{CONTROL}$ . Thermal solutions not designed to provide this level of thermal capability may affect the long-term reliability of the processor and system. When the DTS value is less than  $T_{CONTROL}$ , the thermal solution performance is not defined and the fans may be slowed down. This is unchanged from the prior specification. For more details on thermal solution design, refer to the appropriate processor Thermal and Mechanical Design Guidelines (see [Section 1.2](#)).

The processors implement a methodology for managing processor temperatures, which is intended to support acoustic noise reduction through fan speed control and to assure processor reliability. Selection of the appropriate fan speed is based on the relative temperature data reported by the processor’s Digital Temperature Sensor (DTS). The

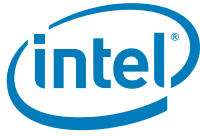

DTS can be read using the Platform Environment Control Interface (PECI) as described in Section 6.3. The temperature reported over Peci is always a negative value and represents a delta below the onset of thermal control circuit (TCC) activation, as indicated by PROCHOT# (see Section 6.2, Processor Thermal Features). Systems that implement fan speed control must be designed to use this data. Systems that do not alter the fan speed only need to ensure the thermal solution provides the  $\Psi_{CA}$  that meets the TTV thermal profile specifications.

A single integer change in the Peci value corresponds to approximately 1 °C change in processor temperature. Although each processors DTS is factory calibrated, the accuracy of the DTS will vary from part to part and may also vary slightly with temperature and voltage. In general, each integer change in Peci should equal a temperature change between 0.9 °C and 1.1 °C.

Analysis indicates that real applications are unlikely to cause the processor to consume maximum power dissipation for sustained time periods. Intel recommends that complete thermal solution designs target the Thermal Design Power (TDP), instead of the maximum processor power consumption. The Adaptive Thermal Monitor feature is intended to help protect the processor in the event that an application exceeds the TDP recommendation for a sustained time period. For more details on this feature, refer to Section 6.2. Refer to the appropriate processor Thermal and Mechanical Design Guidelines (see Section 1.2). for details on system thermal solution design, thermal profiles and environmental considerations.

**Table 6-1. Processor Thermal Specifications**

Processor	Core Frequency	Thermal Design Power (W)	Idle Power (W)	Minimum TTV T <sub>CASE</sub> (°C)	Maximum TTV T <sub>CASE</sub> (°C)	Target Psi-ca Using Processor TTV (°C/W) <sup>5</sup>	Notes
i7-990X	3.46 GHz	130	12	5	See Figure 6-1; Table 6-2	0.222	1, 2, 3, 4, 6
i7-980X	3.33 GHz	130	12	5	See Figure 6-1; Table 6-2	0.222	1, 2, 3, 4, 6
i7-980	3.33 GHz	130	12	5	See Figure 6-2; Table 6-3	0.222	1, 2, 3, 4, 6
i7-970	3.20 GHz	130	12	5	See Figure 6-2; Table 6-3	0.222	1, 2, 3, 4, 6

**Notes:**

1. These values are specified at V<sub>CC\_MAX</sub> for all processor frequencies. Systems must be designed to ensure the processor is not to be subjected to any static V<sub>CC</sub> and I<sub>CC</sub> combination wherein V<sub>CC</sub> exceeds V<sub>CC\_MAX</sub> at specified I<sub>CC</sub>. Refer to the loadline specifications in Chapter 2.
2. Thermal Design Power (TDP) should be used for processor thermal solution design targets. TDP is not the maximum power that the processor can dissipate. TDP is measured at the TCC activation temperature.
3. These specifications are based on initial silicon characterization. These specifications may be further updated as more characterization data becomes available.
4. Power specifications are defined at all VIDs found in Table 2-1. The processor may be shipped under multiple VIDs for each frequency.
5. Target  $\Psi_{ca}$  Using the processor TTV (°C/W) is based on a T<sub>AMBIENT</sub> of 39 °C.
6. Processor idle power is specified under the lowest possible idle state: processor package C6 state. Achieving processor package C6 state is not supported by all chipsets. See the *Intel X58 Express Chipset Datasheet* for more details.

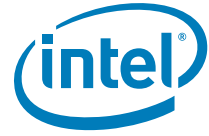

**Figure 6-1. Intel® Core™ i7-900 Desktop Processor Extreme Edition Series Thermal Profile**

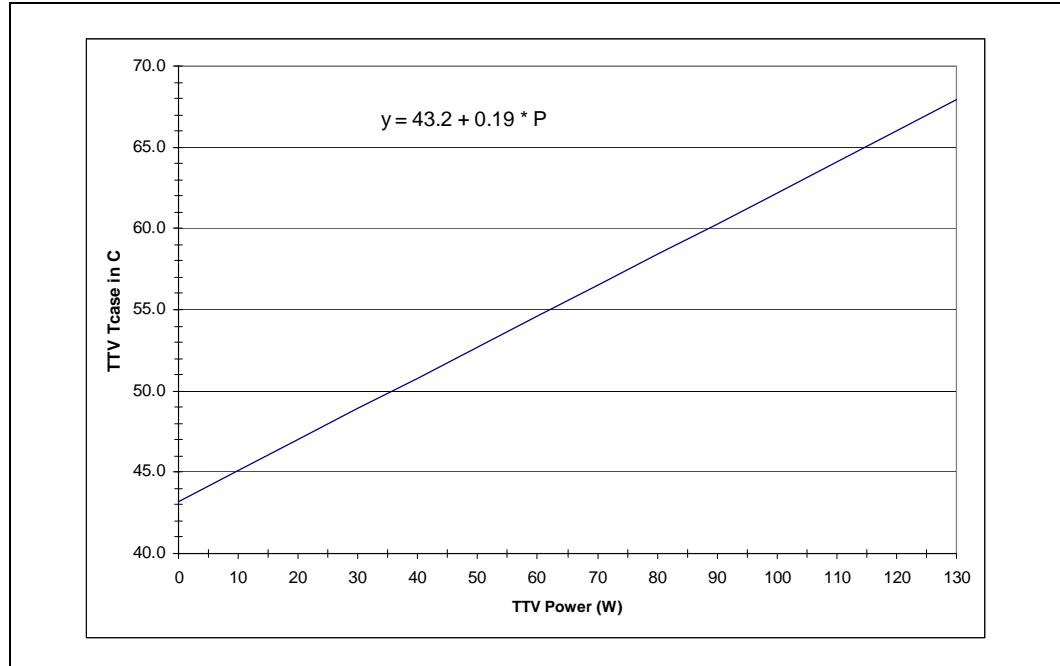

**Notes:**

1. Refer to [Table 6-2](#) for discrete points that constitute the thermal profile.
2. Refer to the appropriate processor Thermal and Mechanical Design Guidelines (see [Section 1.2](#)) for system and environmental implementation details.
3. The thermal profile is based on data from the Thermal Test Vehicle (TTV).

**Table 6-2. Intel® Core™ i7-900 Desktop Processor Extreme Edition Series Thermal Profile**

Power (W)	T <sub>CASE_MAX</sub> (°C)	Power (W)	T <sub>CASE_MAX</sub> (°C)	Power (W)	T <sub>CASE_MAX</sub> (°C)	Power (W)	T <sub>CASE_MAX</sub> (°C)
0	43.2	34	49.7	68	56.1	100	62.2
2	43.6	36	50.0	70	56.5	102	62.6
4	44.0	38	50.4	72	56.9	104	63.0
6	44.3	40	50.8	74	57.3	106	63.3
8	44.7	42	51.2	76	57.6	108	63.7
10	45.1	44	51.6	78	58.0	110	64.1
12	45.5	46	51.9	80	58.4	112	64.5
14	45.9	48	52.3	82	58.8	114	64.9
16	46.2	50	52.7	84	59.2	116	65.2
18	46.6	52	53.1	86	59.5	118	65.6
20	47.0	54	53.5	88	59.9	120	66.0
22	47.4	56	53.8	90	60.3	122	66.4
24	47.8	58	54.2	92	60.7	124	66.8
26	48.1	60	54.6	94	61.1	126	67.1
28	48.5	62	55.0	96	61.4	128	67.5
30	48.9	64	55.4	98	61.8	130	67.9
32	49.3	66	55.7				

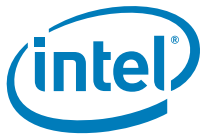
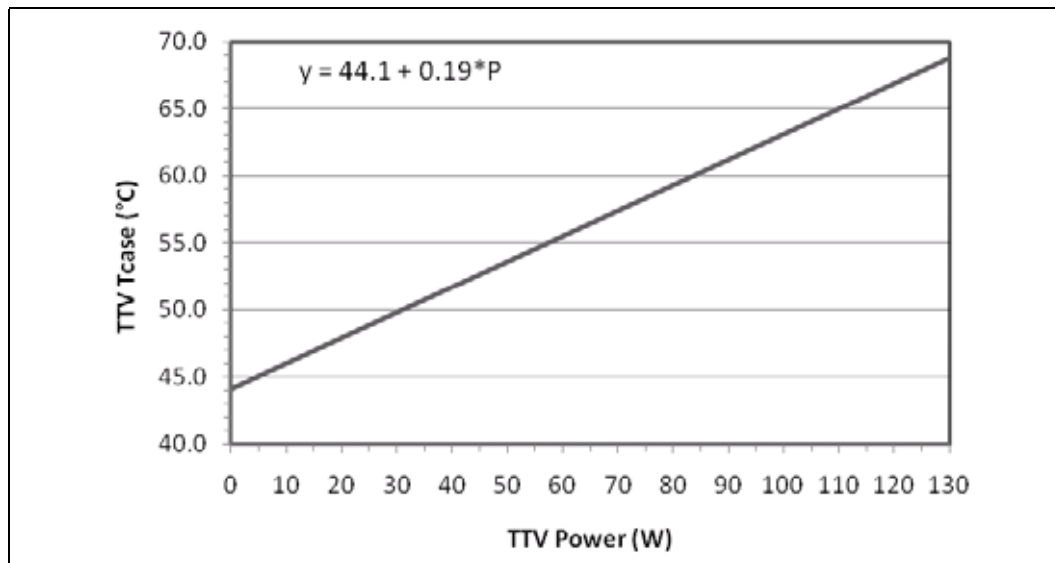

Figure 6-2. Intel® Core™ i7-900 Desktop Processor Series Thermal Profile



**Notes:**

1. Refer to [Table 6-3](#) for discrete points that constitute the thermal profile.
2. Refer to the appropriate processor Thermal and Mechanical Design Guidelines (see [Section 1.2](#)) for system and environmental implementation details.
3. The thermal profile is based on data from the Thermal Test Vehicle (TTV).

Table 6-3. Intel® Core™ i7-900 Desktop Processor Series Thermal Profile

Power (W)	T <sub>CASE_MAX</sub> (°C)	Power (W)	T <sub>CASE_MAX</sub> (°C)	Power (W)	T <sub>CASE_MAX</sub> (°C)	Power (W)	T <sub>CASE_MAX</sub> (°C)
0	44.1	34	50.6	68	57.0	100	63.1
2	44.5	36	50.9	70	57.4	102	63.5
4	44.9	38	51.3	72	57.8	104	63.9
6	45.2	40	51.7	74	58.2	106	64.2
8	45.6	42	52.1	76	58.5	108	64.6
10	46.0	44	52.5	78	58.9	110	65.0
12	46.4	46	52.8	80	59.3	112	65.4
14	46.8	48	53.2	82	59.7	114	65.8
16	47.1	50	53.6	84	60.1	116	66.1
18	47.5	52	54.0	86	60.4	118	66.5
20	47.9	54	54.4	88	60.8	120	66.9
22	48.3	56	54.7	90	61.2	122	67.3
24	48.7	58	55.1	92	61.6	124	67.7
26	49.0	60	55.5	94	62.0	126	68.0
28	49.4	62	55.9	96	62.3	128	68.4
30	49.8	64	56.3	98	62.7	130	68.8
32	50.2	66	56.6				



### 6.1.1.1 Specification for Operation Where Digital Thermal Sensor Exceeds $T_{CONTROL}$

When the DTS value is less than  $T_{CONTROL}$ , the fan speed control algorithm can reduce the speed of the thermal solution fan. This remains the same as with the previous guidance for fan speed control.

During operation where the DTS value is greater than  $T_{CONTROL}$ , the fan speed control algorithm must drive the fan speed to meet or exceed the target thermal solution performance ( $\Psi_{CA}$ ) shown in Table 6-4. The ability to monitor the inlet temperature ( $T_{AMBIENT}$ ) is required to fully implement the specification as the target  $\Psi_{CA}$  is explicitly defined for various ambient temperature conditions. See the appropriate processor Thermal and Mechanical Design Guidelines (see Section 1.2) for details on characterizing the fan speed to  $\Psi_{CA}$  and ambient temperature measurement.

**Table 6-4. Thermal Solution Performance above  $T_{CONTROL}$**

$T_{AMBIENT}^1$	$\Psi_{CA}$ at DTS = $T_{CONTROL}^2$	$\Psi_{CA}$ at DTS = $-1^3$
43.2	0.190	0.190
42.0	0.206	0.199
41.0	0.219	0.207
40.0	0.232	0.215
39.0	0.245	0.222
38.0	0.258	0.230
37.0	0.271	0.238
36.0	0.284	0.245
35.0	0.297	0.253
34.0	0.310	0.261
33.0	0.323	0.268
32.0	0.336	0.276
31.0	0.349	0.284
30.0	0.362	0.292
29.0	0.375	0.299
28.0	0.388	0.307
27.0	0.401	0.315
26.0	0.414	0.322
25.0	0.427	0.330
24.0	0.440	0.338
23.0	0.453	0.345
22.0	0.466	0.353
21.0	0.479	0.361
20.0	0.492	0.368
19.0	0.505	0.376
18.0	0.519	0.384

**Notes:**

1. The ambient temperature is measured at the inlet to the processor thermal solution.
2. This column can be expressed as a function of  $T_{AMBIENT}$  by the following equation:  

$$\Psi_{CA} = 0.19 + (43.2 - T_{AMBIENT}) * 0.013$$
3. This column can be expressed as a function of  $T_{AMBIENT}$  by the following equation:  

$$\Psi_{CA} = 0.19 + (43.2 - T_{AMBIENT}) * 0.0077$$

### 6.1.2 Thermal Metrology

The minimum and maximum TTV case temperatures ( $T_{CASE}$ ) are specified in [Table 6-1](#), and [Table 6-2](#) and are measured at the geometric top center of the thermal test vehicle integrated heat spreader (IHS). [Figure 6-3](#) illustrates the location where  $T_{CASE}$  temperature measurements should be made. For detailed guidelines on temperature measurement methodology and attaching the thermocouple, refer to the appropriate processor Thermal and Mechanical Design Guidelines (see [Section 1.2](#)).

**Figure 6-3. Thermal Test Vehicle (TTV) Case Temperature ( $T_{CASE}$ ) Measurement Location**

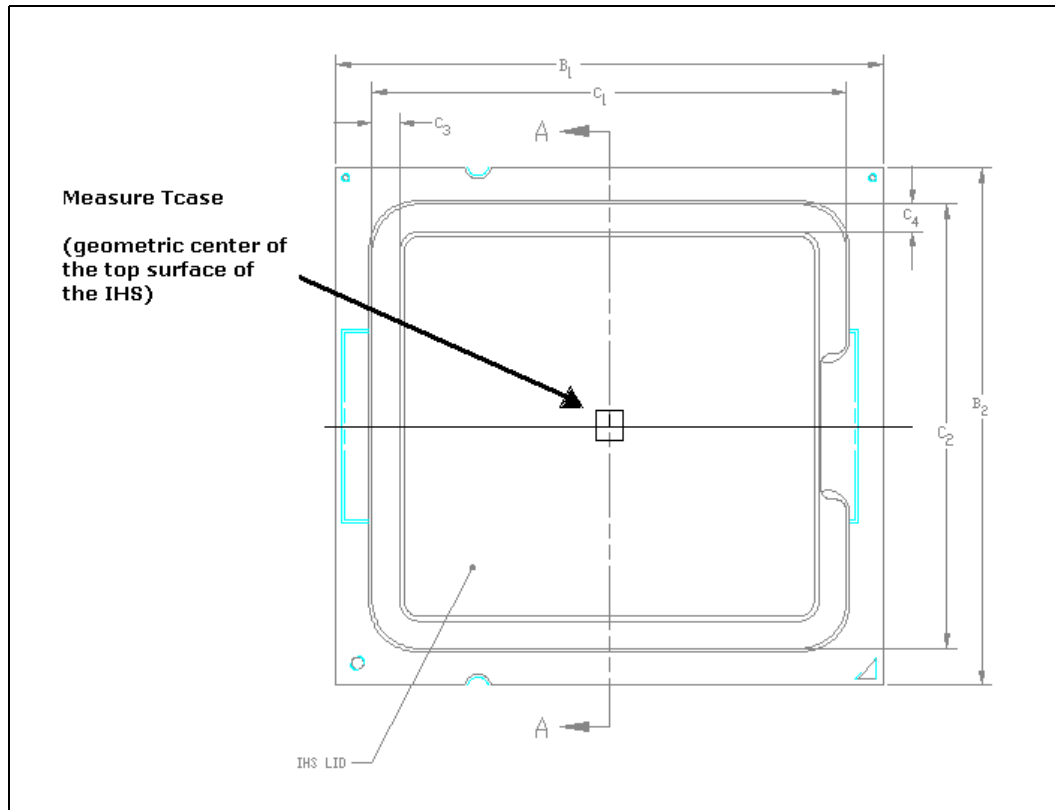

**Notes:**

1. Figure is not to scale and is for reference only.
2. B1: Max = 45.07 mm, Min = 44.93 mm.
3. B2: Max = 42.57 mm, Min = 42.43 mm.
4. C1: Max = 39.1 mm, Min = 38.9 mm.
5. C2: Max = 36.6 mm, Min = 36.4 mm.
6. C3: Max = 2.3 mm, Min = 2.2 mm
7. C4: Max = 2.3 mm, Min = 2.2 mm.
8. Refer to the appropriate Thermal and Mechanical Design Guide (see [Section 1.2](#)) for instructions on thermocouple installation on the processor TTV package.



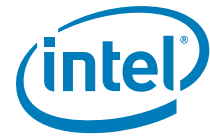

## 6.2 Processor Thermal Features

### 6.2.1 Processor Temperature

The processor contains a software readable field in the IA32\_TEMPERATURE\_TARGET register that contains the minimum temperature at which the TCC will be activated and PROCHOT# will be asserted. The TCC activation temperature is calibrated on a part-by-part basis and normal factory variation may result in the actual TCC activation temperature being higher than the value listed in the register. TCC activation temperatures may change based on processor stepping, frequency or manufacturing efficiencies.

**Note:** There is no specified correlation between DTS temperatures and processor case temperatures; therefore it is not possible to use this feature to ensure the processor case temperature meets the Thermal Profile specifications.

### 6.2.2 Adaptive Thermal Monitor

The Adaptive Thermal Monitor feature provides an enhanced method for controlling the processor temperature when the processor silicon exceeds the Thermal Control Circuit (TCC) activation temperature. Adaptive Thermal Monitor uses TCC activation to reduce processor power using a combination of methods. The first method (Frequency/VID control, similar to Thermal Monitor 2 (TM2) in previous generation processors) involves the processor reducing its operating frequency (using the core ratio multiplier) and input voltage (using the VID signals). This combination of lower frequency and VID results in a reduction of the processor power consumption. The second method (clock modulation, known as Thermal Monitor 1 (TM1) in previous generation processors) reduces power consumption by modulating (starting and stopping) the internal processor core clocks. The processor intelligently selects the appropriate TCC method to use on a dynamic basis. BIOS is not required to select a specific method (as with previous-generation processors supporting TM1 or TM2). The temperature at which Adaptive Thermal Monitor activates the Thermal Control Circuit is factory calibrated and is not user configurable. Snooping and interrupt processing are performed in the normal manner while the TCC is active.

When the TCC activation temperature is reached, the processor will initiate TM2 in attempt to reduce its temperature. If TM2 is unable to reduce the processor temperature, then TM1 will be also be activated. TM1 and TM2 will work together (clocks will be modulated at the lowest frequency ratio) to reduce power dissipation and temperature.

With a properly designed and characterized thermal solution, it is anticipated that the TCC would only be activated for very short periods of time when running the most power intensive applications. The processor performance impact due to these brief periods of TCC activation is expected to be so minor that it would be immeasurable. An under-designed thermal solution that is not able to prevent excessive activation of the TCC in the anticipated ambient environment may cause a noticeable performance loss, and in some cases may result in a  $T_{CASE}$  that exceeds the specified maximum temperature and may affect the long-term reliability of the processor. In addition, a thermal solution that is significantly under-designed may not be capable of cooling the processor even when the TCC is active continuously. Refer to the appropriate processor Thermal and Mechanical Design Guidelines (see [Section 1.2](#)) for information on designing a compliant thermal solution.

The Thermal Monitor does not require any additional hardware, software drivers, or interrupt handling routines. The following sections provide more details on the different TCC mechanisms used by the processor.

### 6.2.2.1 Frequency/VID Control

When the Digital Temperature Sensor (DTS) reaches a value of 0 (DTS temperatures reported using PECI may not equal zero when PROCHOT# is activated, see [Section 6.3](#) for further details), the TCC will be activated and the PROCHOT# signal will be asserted. This indicates the processor temperature has met or exceeded the factory calibrated trip temperature and it will take action to reduce the temperature.

Upon activation of the TCC, the processor will stop the core clocks, reduce the core ratio multiplier by 1 ratio and restart the clocks. All processor activity stops during this frequency transition, which occurs within 2  $\mu$ s. Once the clocks have been restarted at the new lower frequency, processor activity resumes while the voltage requested by the VID lines is stepped down to the minimum possible for the particular frequency. Running the processor at the lower frequency and voltage will reduce power consumption and should allow the processor to cool off. If after 1 ms the processor is still too hot (the temperature has not dropped below the TCC activation point, DTS still = 0 and PROCHOT is still active), then a second frequency and voltage transition will take place. This sequence of temperature checking and Frequency/VID reduction will continue until either the minimum frequency has been reached or the processor temperature has dropped below the TCC activation point.

If the processor temperature remains above the TCC activation point even after the minimum frequency has been reached, then clock modulation (described below) at that minimum frequency will be initiated.

There is no end user software or hardware mechanism to initiate this automated TCC activation behavior.

A small amount of hysteresis has been included to prevent rapid active/inactive transitions of the TCC when the processor temperature is near the TCC activation temperature. Once the temperature has dropped below the trip temperature, and the hysteresis timer has expired, the operating frequency and voltage transition back to the normal system operating point using the intermediate VID/frequency points. Transition of the VID code will occur first, to insure proper operation as the frequency is increased. Refer to [Table 6-4](#) for an illustration of this ordering.

Figure 6-4. Frequency and Voltage Ordering

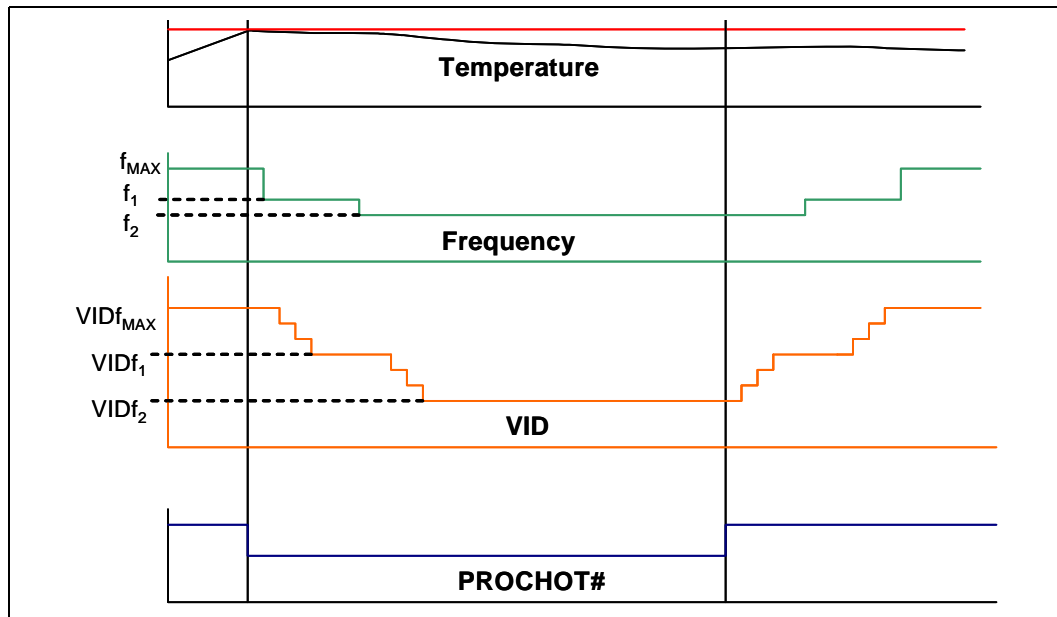



### 6.2.2.2 Clock Modulation

Clock modulation is a second method of thermal control available to the processor. Clock modulation is performed by rapidly turning the clocks off and on at a duty cycle that should reduce power dissipation by about 50% (typically a 30–50% duty cycle). Clocks often will not be off for more than 32 us when the TCC is active. Cycle times are independent of processor frequency. The duty cycle for the TCC, when activated by the Thermal Monitor, is factory configured and cannot be modified.

It is possible for software to initiate clock modulation with configurable duty cycles.

A small amount of hysteresis has been included to prevent rapid active/inactive transitions of the TCC when the processor temperature is near its maximum operating temperature. Once the temperature has dropped below the maximum operating temperature, and the hysteresis timer has expired, the TCC goes inactive and clock modulation ceases.

### 6.2.2.3 Immediate Transition to combined TM1 and TM2

As mentioned above, when the TCC is activated, the processor will sequentially step down the ratio multipliers and VIDs in an attempt to reduce the silicon temperature. If the temperature continues to increase and exceeds the TCC activation temperature by approximately 5 °C before the lowest ratio/VID combination has been reached, then the processor will immediately transition to the combined TM1/TM2 condition. The processor will remain in this state until the temperature has dropped below the TCC activation point. Once below the TCC activation temperature, TM1 will be discontinued and TM2 will be exited by stepping up to the appropriate ratio/VID state.

### 6.2.2.4 Critical Temperature Flag

If TM2 is unable to reduce the processor temperature, then TM1 will be also be activated. TM1 and TM2 will then work together to reduce power dissipation and temperature. It is expected that only a catastrophic thermal solution failure would create a situation where both TM1 and TM2 are active.

If TM1 and TM2 have both been active for greater than 20 ms and the processor temperature has not dropped below the TCC activation point, then the Critical Temperature Flag in the IA32\_THERM\_STATUS MSR will be set. This flag is an indicator of a catastrophic thermal solution failure and that the processor cannot reduce its temperature. Unless immediate action is taken to resolve the failure, the processor will probably reach the Thermtrip temperature (see [Section 6.2.3](#)) within a short time. To prevent possible permanent silicon damage, Intel recommends removing power from the processor within ½ second of the Critical Temperature Flag being set.

### 6.2.2.5 PROCHOT# Signal

An external signal, PROCHOT# (processor hot), is asserted when the processor core temperature has exceeded its specification. If Adaptive Thermal Monitor is enabled (note that it must be enabled for the processor to be operating within specification), the TCC will be active when PROCHOT# is asserted.

The processor can be configured to generate an interrupt upon the assertion or de-assertion of PROCHOT#.

Although the PROCHOT# signal is an output by default, it may be configured as bi-directional. When configured in bi-directional mode, it is either an output indicating the processor has exceeded its TCC activation temperature or it can be driven from an

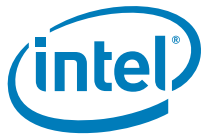

external source (such as, a voltage regulator) to activate the TCC. The ability to activate the TCC using PROCHOT# can provide a means for thermal protection of system components.

As an output, PROCHOT# (Processor Hot) will go active when the processor temperature monitoring sensor detects that one or more cores has reached its maximum safe operating temperature. This indicates that the processor Thermal Control Circuit (TCC) has been activated, if enabled. As an input, assertion of PROCHOT# by the system will activate the TCC for all cores. TCC activation when PROCHOT# is asserted by the system will result in the processor immediately transitioning to the minimum frequency and corresponding voltage (using Freq/VID control). Clock modulation is not activated in this case. The TCC will remain active until the system de-asserts PROCHOT#.

Use of PROCHOT# in bi-directional mode can allow VR thermal designs to target maximum sustained current instead of maximum current. Systems should still provide proper cooling for the VR, and rely on PROCHOT# only as a backup in case of system cooling failure. The system thermal design should allow the power delivery circuitry to operate within its temperature specification even while the processor is operating at its Thermal Design Power.

### 6.2.3 THERMTRIP# Signal

Regardless of whether or not Adaptive Thermal Monitor is enabled, in the event of a catastrophic cooling failure, the processor will automatically shut down when the silicon has reached an elevated temperature (refer to the THERMTRIP# definition in [Table 5-1](#)). THERMTRIP# activation is independent of processor activity. The temperature at which THERMTRIP# asserts is not user configurable and is not software visible.

## 6.3 Platform Environment Control Interface (PECI)

### 6.3.1 Introduction

The Platform Environment Control Interface (PECI) is a one-wire interface that provides a communication channel between the Intel processor and chipset components to external monitoring devices. The processor implements a PECI interface to allow communication of processor thermal and other information to other devices on the platform. The processor provides a digital thermal sensor (DTS) for fan speed control. The DTS is calibrated at the factory to provide a digital representation of relative processor temperature. Instantaneous temperature readings from the DTS are available using the IA32\_THERM\_STATUS MSR; averaged DTS values are read using the PECI interface.

The PECI physical layer is a self-clocked one-wire bus that begins each bit with a driven, rising edge from an idle level near zero volts. The duration of the signal driven high depends on whether the bit value is a logic '0' or logic '1'. PECI also includes variable data transfer rate established with every message. The single wire interface provides low board routing overhead for the multiple load connections in the congested routing area near the processor and chipset components. Bus speed, error checking, and low protocol overhead provides adequate link bandwidth and reliability to transfer critical device operating conditions and configuration information.

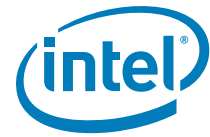

### 6.3.1.1 Fan Speed Control with Digital Thermal Sensor

Fan speed control solutions use a value stored in the static variable,  $T_{\text{CONTROL}}$ . The DTS temperature data that is delivered over PECI (in response to a GetTemp0() command), is compared to this  $T_{\text{CONTROL}}$  reference. The DTS temperature is reported as a relative value versus an absolute value. The temperature reported over PECI is always a negative value and represents a delta below the onset of thermal control circuit (TCC) activation, as indicated by PROCHOT#. Therefore, as the temperature approaches TCC activation, the value approaches zero degrees.

### 6.3.1.2 Processor Thermal Data Sample Rate and Filtering

The processor digital thermal sensor (DTS) provides an improved capability to monitor device hot spots that inherently leads to more varying temperature readings over short time intervals. To reduce the sample rate requirements on PECI and improve thermal data stability versus time the processor DTS implements an averaging algorithm that filters the incoming data. This filter is expressed mathematically as:

$$\text{PECI}(t) = \text{PECI}(t-1) + 1 / (2^{X}) * [\text{Temp} - \text{PECI}(t-1)]$$

Where: PECI(t) is the new averaged temperature, PECI(t-1) is the previous averaged temperature; Temp is the raw temperature data from the DTS; X is the Thermal Averaging Constant (TAC)

**Note:** Only values read using the PECI interface are averaged. Temperature values read using the IA32\_THERM\_STATUS MSR are not averaged.

The Thermal Averaging Constant is a BIOS configurable value that determines the time in milliseconds over which the DTS temperature values are averaged. Short averaging times will make the averaged temperature values respond more quickly to DTS changes. Long averaging times will result in better overall thermal smoothing but also incur a larger time lag between fast DST temperature changes and the value read using PECI. Refer to the appropriate processor Thermal and Mechanical Design Guidelines (see [Section 1.2](#)) for further details on the Data Filter and the Thermal Averaging Constant.

Within the processor, the DTS converts an analog signal into a digital value representing the temperature relative to TCC activation. The conversions are in integers with each single number change corresponding to approximately 1 °C. DTS values reported using the internal processor MSR will be in whole integers.

As a result of the averaging function described above, DTS values reported over PECI will include a 6-bit fractional value. Under typical operating conditions, where the temperature is close to  $T_{\text{CONTROL}}$ , the fractional values may not be of interest. But when the temperature approaches zero, the fractional values can be used to detect the activation of the TCC. An averaged temperature value between 0 and 1 can only occur if the TCC has been activated during the averaging window. As TCC activation time increases, the fractional value will approach zero. Fan control circuits can detect this situation and take appropriate action as determined by the system designers. Of course, fan control chips can also monitor the PROCHOT# pin to detect TCC activation using a dedicated input pin on the package. Further details on how the Thermal Averaging Constant influences the fractional temperature values are available in the Thermal Design Guide.

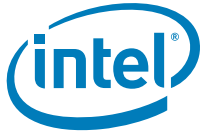

## 6.3.2 PECCI Specifications

### 6.3.2.1 PECCI Device Address

The PECCI register resides at address 30h.

### 6.3.2.2 PECCI Command Support

The processor supports the PECCI commands listed in [Table 6-5](#).

**Table 6-5. Supported PECCI Command Functions and Codes**

Command Function	Code	Comments
Ping()	N/A	This command targets a valid PECCI device address followed by zero Write Length and zero Read Length.
GetTemp0()	01h	Write Length: 1 Read Length: 2 Returns the temperature of the processor in Domain 0

### 6.3.2.3 PECCI Fault Handling Requirements

PECCI is largely a fault tolerant interface, including noise immunity and error checking improvements over other comparable industry standard interfaces. The PECCI client is as reliable as the device that it is embedded in, and thus given operating conditions that fall under the specification. The PECCI will always respond to requests and the protocol itself can be relied upon to detect any transmission failures. There are, however, certain scenarios where the PECCI is known to be unresponsive. Prior to a power on RESET# and during RESET# assertion, PECCI is not ensured to provide reliable thermal data. System designs should implement a default power-on condition that ensures proper processor operation during the time frame when reliable data is not available using PECCI.

To protect platforms from potential operational or safety issues due to an abnormal condition on PECCI, the host controller should take action to protect the system from possible damaging states. If the host controller cannot complete a valid PECCI transactions of GetTemp0() with a given PECCI device over 3 consecutive failed transactions or a one second maximum specified interval, then it should take appropriate actions to protect the corresponding device and/or other system components from overheating. The host controller may also implement an alert to software in the event of a critical or continuous fault condition.

### 6.3.2.4 PECCI GetTemp0() Error Code Support

The error codes supported for the processor GetTemp() command are listed in [Table 6-6](#).

**Table 6-6. GetTemp0() Error Codes**

Error Code	Description
8000h	General sensor error



## 6.4 Storage Conditions Specifications

Environmental storage condition limits define the temperature and relative humidity limits to which the device is exposed to while being stored. The specified storage conditions are for component level prior to board attach (see following notes on post board attach limits).

Table 6-7 specifies absolute maximum and minimum storage temperature limits that represent the maximum or minimum device condition beyond which damage, latent or otherwise, may occur. The table also specifies sustained storage temperature, relative humidity, and time-duration limits. At conditions outside sustained limits, but within absolute maximum and minimum ratings, quality and reliability may be affected.

**Table 6-7. Storage Condition Ratings**

Symbol	Parameter	Min	Max	Notes
T <sub>abs storage</sub>	The minimum/maximum device storage temperature beyond which damage (latent or otherwise) may occur when subjected to for any length of time.	-55 °C	125 °C	1, 2, 3, 4, 5
T <sub>sustained storage</sub>	The minimum/maximum device storage temperature for a sustained period of time	-5 °C	40 °C	1, 2, 3, 4, 5
RH <sub>sustained storage</sub>	The maximum device storage relative humidity for a sustained period of time	—	60% @ 24 °C	1, 2, 3, 4, 5
Time <sub>sustained storage</sub>		0 months	6 months	1, 2, 3, 4, 5

**Notes:**

- Storage conditions are applicable to storage environments only. In this scenario, the processor must not receive a clock, and no lands can be connected to a voltage bias. Storage within these limits will not affect the long-term reliability of the device. For functional operation, refer to the processor case temperature specifications.
- These ratings apply to the Intel component and do not include the tray or packaging.
- Failure to adhere to this specification can affect the long-term reliability of the processor.
- Non operating storage limits for post board attach: Storage condition limits for the component, once attached to the application board, are not specified.
- Device storage temperature qualification methods follow JESD22-A119 (low temp) and JESD22-A103 (high temp) standards.



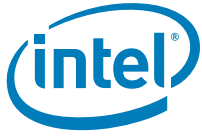



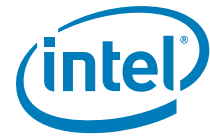

# 7 Features

## 7.1 Power-On Configuration (POC)

Several configuration options can be configured by hardware. For electrical specifications on these options, refer to [Chapter 2](#). Note that request to execute BIST is not selected by hardware but is passed across the Intel QPI link during initialization.

The sampled information configures the processor for subsequent operation. These configuration options cannot be changed except by another reset. All resets reconfigure the processor; for reset purposes, the processor does not distinguish between a "warm" reset and a "power-on" reset.

**Table 7-1. Power On Configuration Signal Options**

Configuration Option	Signal
MSID	VID[2:0]/MSID[2:0] <sup>1, 2</sup>
CSC	VID[5:3]/CSC[2:0] <sup>1, 2</sup>

**Notes:**

1. Latched when VTPWRGOOD is asserted and all internal power good conditions are met.
2. See the signal definitions in [Table 6-1](#) for the description of MSID and CSC.

## 7.2 Clock Control and Low Power States

The processor supports low power states at the individual thread, core, and package level for optimal power management. The processor implements software interfaces for requesting low power states: MWAIT instruction extensions with sub-state hints, the HLT instruction (for C1 and C1E) and P\_LVLx reads to the ACPI P\_BLK register block mapped in the processor's I/O address space. The P\_LVLx I/O reads are converted to equivalent MWAIT C-state requests inside the processor and do not directly result in I/O reads to the system. The P\_LVLx I/O Monitor address does not need to be set up before using the P\_LVLx I/O read interface.

Software may make C-state requests by using a legacy method involving I/O reads from the ACPI-defined processor clock control registers, referred to as P\_LVLx. This feature is designed to provide legacy support for operating systems that initiate C-state transitions using access to pre-defined ICH registers. The base P\_LVLx register is P\_LVL2, corresponding to a C3 request. P\_LVL3 is C6.

P\_LVL2 is defined in the PMG\_IO\_CAPTURE MSR. P\_LVLx is limited to a subset of C-states. For Example, P\_LVL8 is not supported and will not cause an I/O redirection to a C8 request. Instead, it will fall through like a normal I/O instruction. The range of I/O addresses that may be converted into C-state requests is also defined in the PMG\_IO\_CAPTURE MSR, in the 'C-state Range' field. This field may be written by BIOS to restrict the range of I/O addresses that are trapped and redirected to MWAIT instructions. Note that when I/O instructions are used, no MWAIT substates can be defined, as therefore the request defaults to have a sub-state or zero, but always assumes the 'break on IF==0' control that can be selected using ECX with an MWAIT instruction.

Figure 7-1. Power State

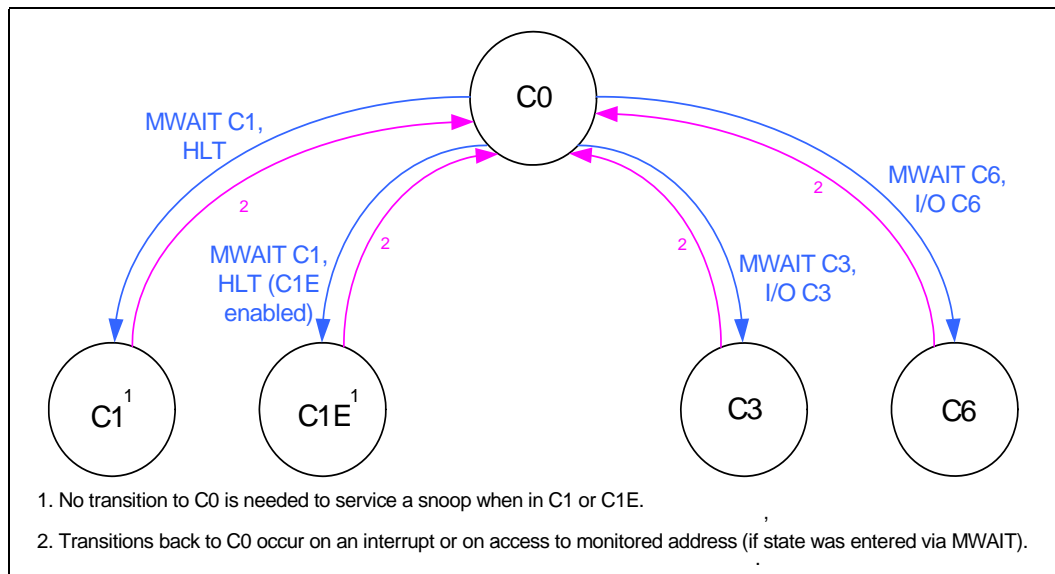

## 7.2.1 Thread and Core Power State Descriptions

Individual threads may request low power states. Core power states are automatically resolved by the processor as shown in Table 7-2.

Table 7-2. Coordination of Thread Power States at the Core Level

Core State		Thread1 State			
		C0	C1 <sup>1</sup>	C3	C6
Thread0 State	C0	C0	C0	C0	C0
	C1 <sup>1</sup>	C0	C1 <sup>1</sup>	C1 <sup>1</sup>	C1 <sup>1</sup>
	C3	C0	C1 <sup>1</sup>	C3	C3
	C6	C0	C1 <sup>1</sup>	C3	C6

**Notes:**

1. If enabled, state will be C1E.

### 7.2.1.1 C0 State

This is the normal operating state in the processor.

### 7.2.1.2 C1/C1E State

C1/C1E is a low power state entered when all threads within a core execute a HLT or MWAIT(C1E) instruction. The processor thread will transition to the C0 state upon occurrence of an interrupt or an access to the monitored address if the state was entered using the MWAIT instruction. RESET# will cause the processor to initialize itself.

A System Management Interrupt (SMI) handler will return execution to either Normal state or the C1 state. See the *Intel® 64 and IA-32 Architecture Software Developer's Manuals, Volume III: System Programmer's Guide* for more information.

While in C1/C1E state, the processor will process bus snoops and snoops from the other threads.



### 7.2.1.3 C3 State

Individual threads of the processor can enter the C3 state by initiating a P\_LVL2 I/O read to the P\_BLK or an MWAIT(C3) instruction. Before entering core C3, the processor flushes the contents of its caches. Except for the caches, the processor core maintains all its architectural state while in the C3 state. All of the clocks in the processor core are stopped in the C3 state.

Because the core's caches are flushed, the processor keeps the core in the C3 state when the processor detects a snoop on the Intel QPI Link or when another logical processor in the same package accesses cacheable memory. The processor core will transition to the C0 state upon occurrence of an interrupt. RESET# will cause the processor core to initialize itself.

### 7.2.1.4 C6 State

Individual threads of the processor can enter the C6 state by initiating a P\_LVL3 read to the P\_BLK or an MWAIT(C6) instruction. Before entering Core C6, the processor saves core state data (such as, registers) to the last level cache. This data is retired after exiting core C6. The processor achieves additional power savings in the core C6 state.

## 7.2.2 Package Power State Descriptions

The package supports C0, C3, and C6 power states. Note that there is no package C1 state. The package power state is automatically resolved by the processor depending on the core power states and permission from the rest of the system as described in the following sections.

### 7.2.2.1 Package C0 State

This is the normal operating state for the processor. The processor remains in the Normal state when at least one of its cores is in the C0 or C1 state or when another component in the system has not granted permission to the processor to go into a low power state. Individual components of the processor may be in low power states while the package is in C0.

### 7.2.2.2 Package C1/C1E State

The package will enter the C1/C1E low power state when at least one core is in the C1/C1E state and the rest of the cores are in the C1/C1E or lower power state. The processor will also enter the C1/C1E state when all cores are in a power state lower than C1/C1E but the package low power state is limited to C1/C1E using the PMG\_CST\_CONFIG\_CONTROL MSR. In the C1E state, the processor will automatically transition to the lowest power operating point (lowest supported voltage and associated frequency). When entering the C1E state, the processor will first switch to the lowest bus ratio and then transition to the lower VID. No notification to the system occurs upon entry to C1/C1E.

### 7.2.2.3 Package C3 State

The package will enter the C3 low power state when all cores are in the C3 or lower power state and the processor has been granted permission by the other component(s) in the system to enter the C3 state. The package will also enter the C3 state when all cores are in an idle state lower than C3 but other component(s) in the system have only granted permission to enter C3.

If Intel QPI L1 has been granted, the processor will disable some clocks and PLLs and for processors with an integrated memory controller, the DRAM will be put into self-refresh.

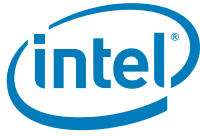

### 7.2.2.4 Package C6 State

The package will enter the C6 low power state when all cores are in the C6 or lower power state and the processor has been granted permission by the other component(s) in the system to enter the C6 state. The package will also enter the C6 state when all cores are in an idle state lower than C6 but the other component(s) have only granted permission to enter C6.

If Intel QPI L1 has been granted, the processor will disable some clocks and PLLs and the shared cache will enter a deep sleep state. Additionally, for processors with an integrated memory controller, the DRAM will be put into self-refresh.

## 7.3 Sleep States

The processor supports the ACPI sleep states S0, S1, S3, and S4/S5 as shown in Table 7-3. For information on ACPI S-states and related terminology, refer to ACPI Specification. The S-state transitions are coordinated by the processor in response PM Request (PMReq) messages from the chipset. The processor itself will never request a particular S-state.

Table 7-3. Processor S-States

S-State	Power Reduction	Allowed Transitions
S0	Normal Code Execution	S1 (using PMReq)
S1	Cores in C1E like state, processor responds with CmpD(S1) message.	S0 (using reset or PMReq) S3, S4 (using PMReq)
S3	Memory put into self-refresh, processor responds with CmpD(S3) message.	S0 (using reset)
S4/S5	Processor responds with CmpD(S4/S5) message.	S0 (using reset)

**Notes:**

1. If the chipset requests an S-state transition, which is not allowed, a machine check error will be generated by the processor.

## 7.4 ACPI P-States (Intel® Turbo Boost Technology)

The processor supports ACPI P-States. A new feature is that the P0 ACPI state will be a request for Turbo Boost Technology. Turbo Boost Technology opportunistically and automatically allows the processor to run faster than its marked frequency if the processor is operating below power, thermal, and current specifications. Maximum turbo frequency is dependant on the processor component and number of active cores. No special hardware support is necessary for Turbo Boost Technology. BIOS and the operating system can enable or disable Turbo Boost Technology.

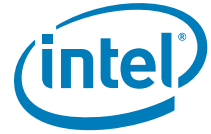

## 7.5 Enhanced Intel SpeedStep<sup>®</sup> Technology

The processor features Enhanced Intel SpeedStep Technology. Following are the key features of Enhanced Intel SpeedStep Technology:

- Multiple voltage and frequency operating points provide optimal performance at the lowest power.
- Voltage and frequency selection is software controlled by writing to processor MSRs:
  - If the target frequency is higher than the current frequency,  $V_{CC}$  is ramped up in steps by placing new values on the VID pins and the PLL then locks to the new frequency.
  - If the target frequency is lower than the current frequency, the PLL locks to the new frequency and the  $V_{CC}$  is changed through the VID pin mechanism.
  - Software transitions are accepted at any time. If a previous transition is in progress, the new transition is deferred until the previous transition completes.
- The processor controls voltage ramp rates internally to ensure smooth transitions.
- Low transition latency and large number of transitions possible per second:
  - Processor core (including shared cache) is unavailable for less than 5  $\mu$ s during the frequency transition.





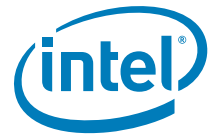

# 8 Boxed Processor Specifications

## 8.1 Introduction

The processor will also be offered as an Intel boxed processor. Intel boxed processors are intended for system integrators who build systems from baseboards and standard components. The boxed processor will be supplied with a cooling solution. This chapter documents baseboard and system requirements for the cooling solution that will be supplied with the boxed processor. This chapter is particularly important for OEMs that manufacture baseboards for system integrators.

**Note:** Unless otherwise noted, all figures in this chapter are dimensioned in millimeters and inches [in brackets]. [Figure 8-1](#) shows a mechanical representation of a boxed processor.

**Note:** Drawings in this section reflect only the specifications on the Intel boxed processor product. These dimensions should not be used as a generic keep-out zone for all cooling solutions. It is the system designers' responsibility to consider their proprietary cooling solution when designing to the required keep-out zone on their system platforms and chassis. Refer to the appropriate processor Thermal and Mechanical Design Guidelines (see [Section 1.2](#)) for further guidance. Contact your local Intel Sales Representative for this document.

**Figure 8-1. Mechanical Representation of the Boxed Processor**

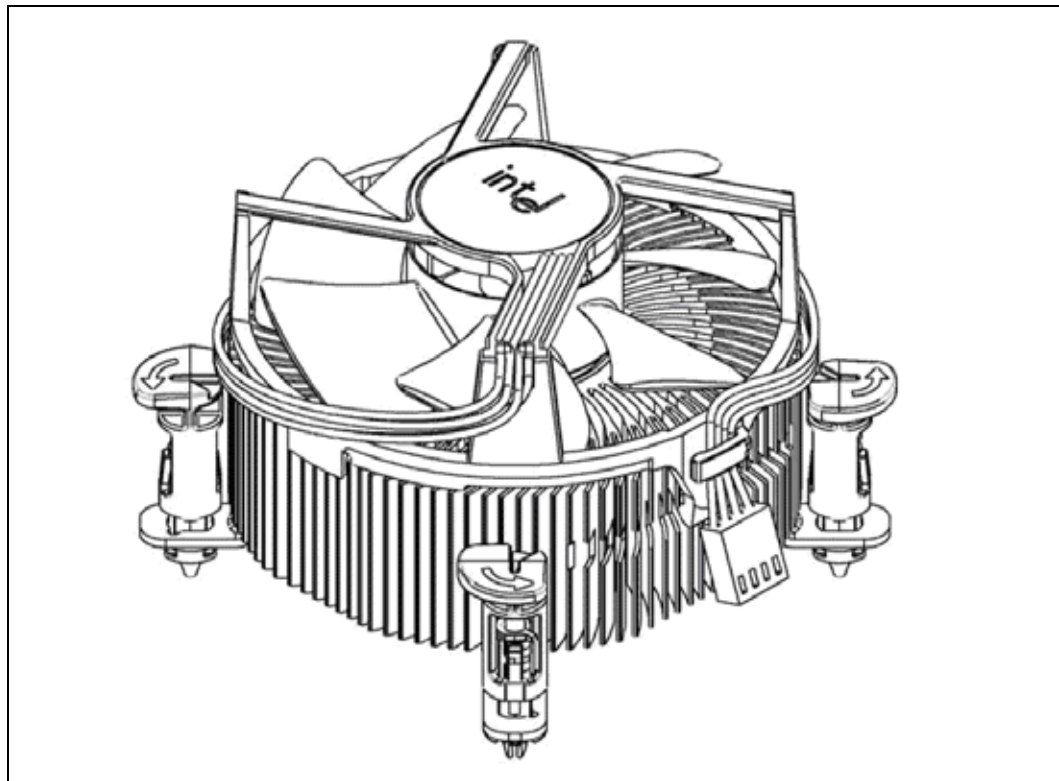

**Note:** The airflow of the fan heatsink is into the center and out of the sides of the fan heatsink.

## 8.2 Mechanical Specifications

### 8.2.1 Boxed Processor Cooling Solution Dimensions

This section covers the mechanical specifications of the boxed processor. The boxed processor will be shipped with an unattached fan heatsink. [Figure 8-1](#) shows a mechanical representation of the boxed processor.

Clearance is required around the fan heatsink to ensure unimpeded airflow for proper cooling. The physical space requirements and dimensions for the boxed processor with assembled fan heatsink are shown in [Figure 8-2](#) (side view), and [Figure 8-3](#) (top view). The airspace requirements for the boxed processor fan heatsink must also be incorporated into new baseboard and system designs. Airspace requirements are shown in [Figure 8-7](#) and [Figure 8-8](#). Note that some figures have centerlines shown (marked with alphabetic designations) to clarify relative dimensioning.

**Figure 8-2. Space Requirements for the Boxed Processor (side view)**

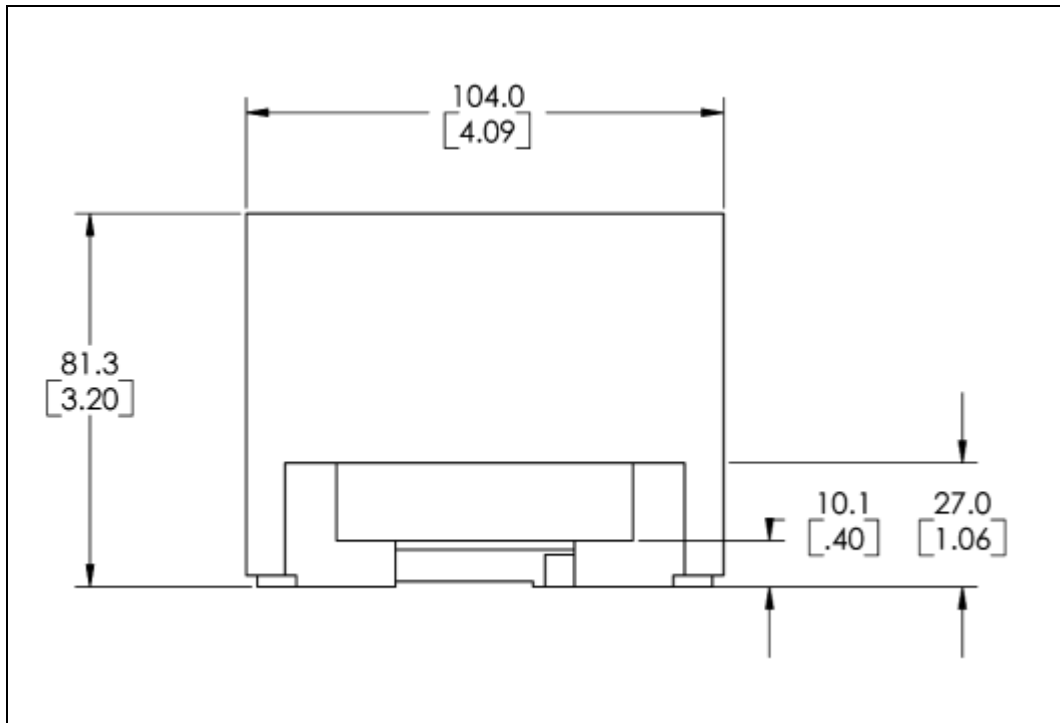



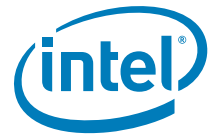

**Figure 8-3. Space Requirements for the Boxed Processor (top view)**

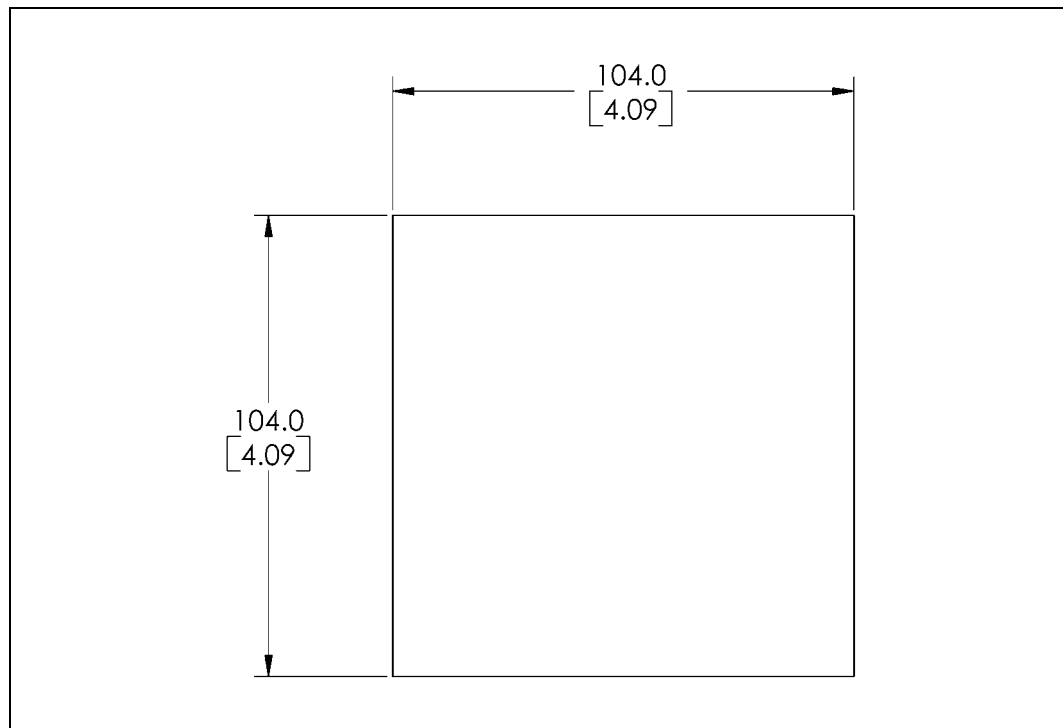

**Notes:**

1. Diagram does not show the attached hardware for the clip design and is provided only as a mechanical representation.

**Figure 8-4. Space Requirements for the Boxed Processor (overall view)**

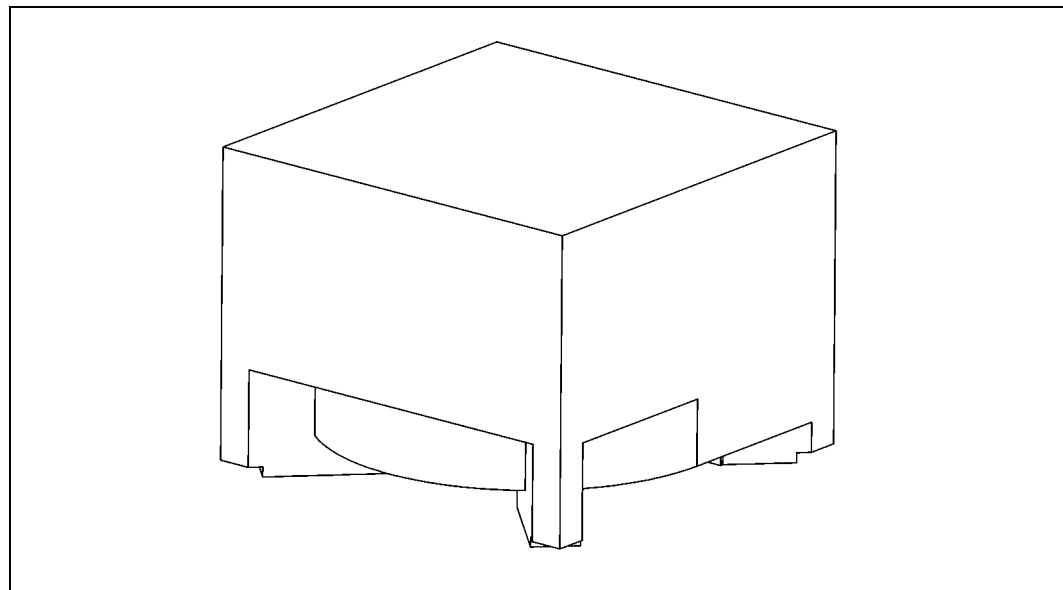

### 8.2.2 Boxed Processor Fan Heatsink Weight

The boxed processor fan heatsink will not weigh more than 550 grams. See [Chapter 6](#) and the appropriate processor Thermal and Mechanical Design Guidelines (see [Section 1.2](#)) for details on the processor weight and heatsink requirements.

### 8.2.3 Boxed Processor Retention Mechanism and Heatsink Attach Clip Assembly

The boxed processor thermal solution requires a heatsink attach clip assembly to secure the processor and fan heatsink in the baseboard socket. The boxed processor will ship with the heatsink attach clip assembly.

## 8.3 Electrical Requirements

### 8.3.1 Fan Heatsink Power Supply

The boxed processor's fan heatsink requires a +12 V power supply. A fan power cable will be shipped with the boxed processor to draw power from a power header on the baseboard. The power cable connector and pinout are shown in [Figure 8-5](#). Baseboards must provide a matched power header to support the boxed processor. [Table 8-1](#) contains specifications for the input and output signals at the fan heatsink connector.

The fan heatsink outputs a SENSE signal that is an open-collector output that pulses at a rate of 2 pulses per fan revolution. A baseboard pull-up resistor provides  $V_{OH}$  to match the system board-mounted fan speed monitor requirements, if applicable. Use of the SENSE signal is optional. If the SENSE signal is not used, pin 3 of the connector should be tied to GND.

The fan heatsink receives a PWM signal from the motherboard from the 4th pin of the connector labeled as CONTROL.

The boxed processor's fan heatsink requires a constant +12 V supplied to pin 2 and does not support variable voltage control or 3-pin PWM control.

The power header on the baseboard must be positioned to allow the fan heatsink power cable to reach it. The power header identification and location should be documented in the platform documentation, or on the system board itself. [Figure 8-6](#) shows the location of the fan power connector relative to the processor socket. The baseboard power header should be positioned within 110 mm [4.33 inches] from the center of the processor socket.

**Figure 8-5. Boxed Processor Fan Heatsink Power Cable Connector Description**

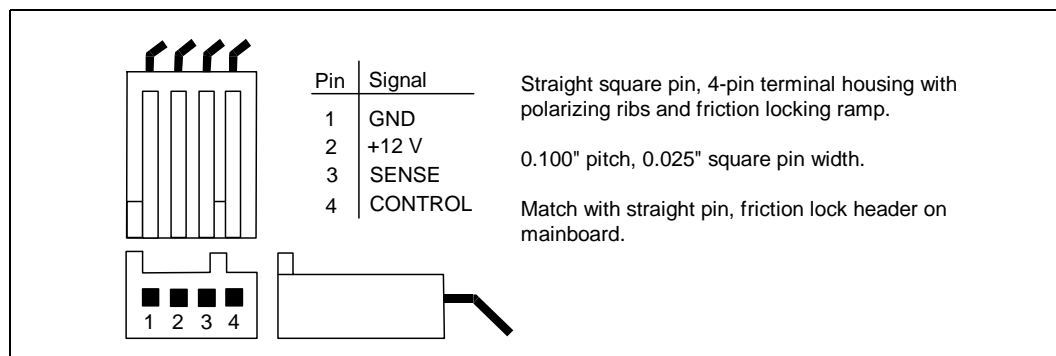

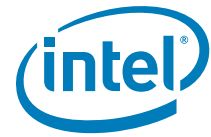

**Table 8-1. Fan Heatsink Power and Signal Specifications**

Description	Min	Typ	Max	Unit	Notes
+12 V: 12 volt fan power supply	10.8	12	13.2	V	-
IC:					
- Peak steady-state fan current draw	—	—	3.0	A	-
- Average steady-state fan current draw	—	—	2.0	A	-
SENSE: SENSE frequency	—	2	—	pulses per fan revolution	1
CONTROL	21	25	28	kHz	2, 3

**Notes:**

1. Baseboard should pull this pin up to 5 V with a resistor.
2. Open drain type, pulse width modulated.
3. Fan will have pull-up resistor for this signal to maximum of 5.25 V.

**Figure 8-6. Baseboard Power Header Placement Relative to Processor Socket**

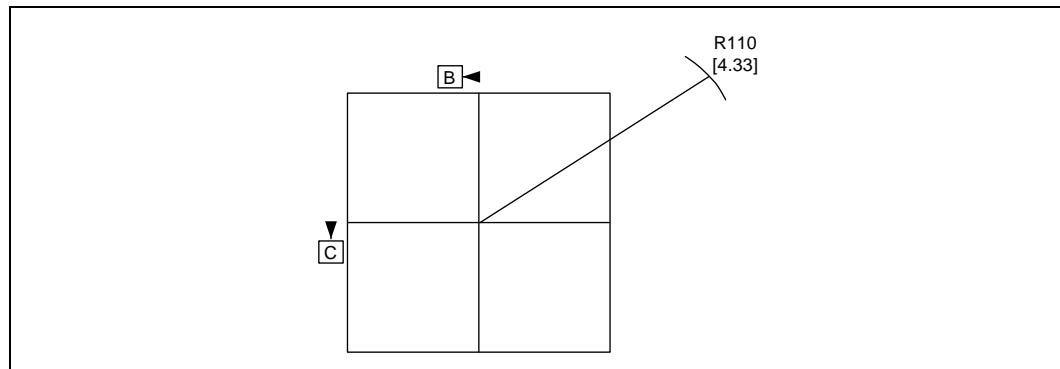

## 8.4 Thermal Specifications

This section describes the cooling requirements of the fan heatsink solution used by the boxed processor.

### 8.4.1 Boxed Processor Cooling Requirements

The boxed processor may be directly cooled with a fan heatsink. However, meeting the processor's temperature specification is also a function of the thermal design of the entire system, and ultimately the responsibility of the system integrator. The processor temperature specification is found in [Chapter 6](#) of this document. The boxed processor fan heatsink is able to keep the processor temperature within the specifications (see [Table 6-1](#)) in chassis that provide good thermal management. For the boxed processor fan heatsink to operate properly, it is critical that the airflow provided to the fan heatsink is unimpeded. Airflow of the fan heatsink is into the center and out of the sides of the fan heatsink. Airspace is required around the fan to ensure that the airflow through the fan heatsink is not blocked. Blocking the airflow to the fan heatsink reduces the cooling efficiency and decreases fan life. [Figure 8-7](#) and [Figure 8-8](#) illustrate an acceptable airspace clearance for the fan heatsink. The air temperature entering the fan should be kept below 40 °C. Again, meeting the processor's temperature specification is the responsibility of the system integrator.

Figure 8-7. Boxed Processor Fan Heatsink Airspace Keepout Requirements (top view)

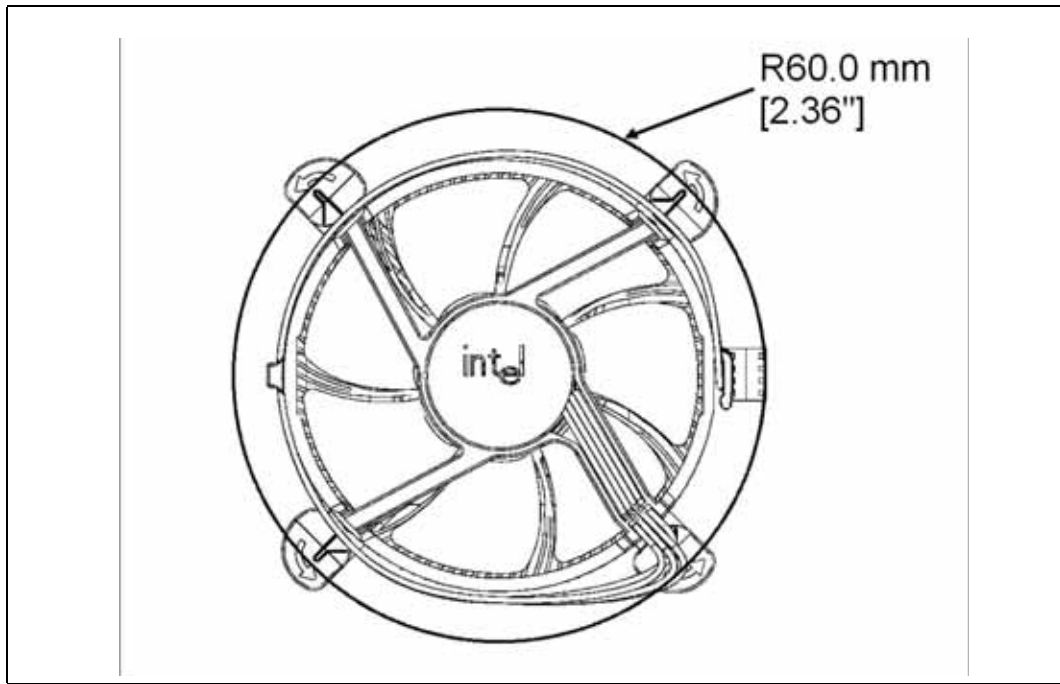
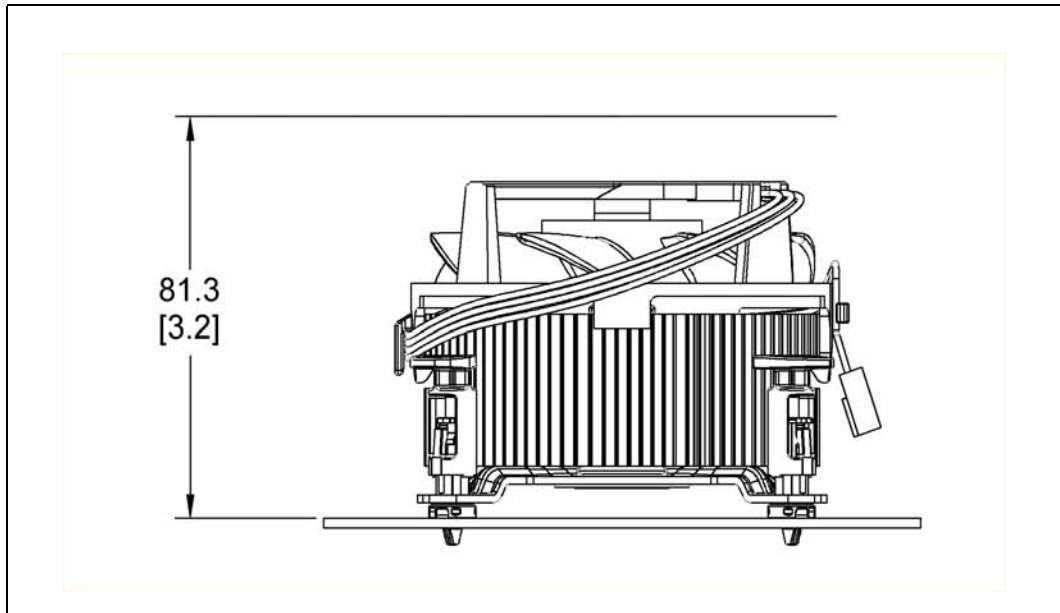
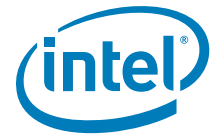

Figure 8-8. Boxed Processor Fan Heatsink Airspace Keepout Requirements (side view)





### 8.4.2 Variable Speed Fan

If the boxed processor fan heatsink 4-pin connector is connected to a 3-pin motherboard header, it will operate as follows:

The boxed processor fan will operate at different speeds over a short range of internal chassis temperatures. This allows the processor fan to operate at a lower speed and noise level, while internal chassis temperatures are low. If the internal chassis temperature increases beyond a lower set point, the fan speed will rise linearly with the internal temperature until the higher set point is reached. At that point, the fan speed is at its maximum. As fan speed increases, so does fan noise levels. Systems should be designed to provide adequate air around the boxed processor fan heatsink that remains cooler than the lower set point. These set points, represented in Figure 8-9 and Table 8-2, can vary by a few degrees from fan heatsink to fan heatsink. The internal chassis temperature should be kept below 40 °C. Meeting the processor's temperature specification (see Chapter 6) is the responsibility of the system integrator.

The motherboard must supply a constant +12 V to the processor's power header to ensure proper operation of the variable speed fan for the boxed processor. Refer to Table 8-1 for the specific requirements.

**Figure 8-9. Boxed Processor Fan Heatsink Set Points**

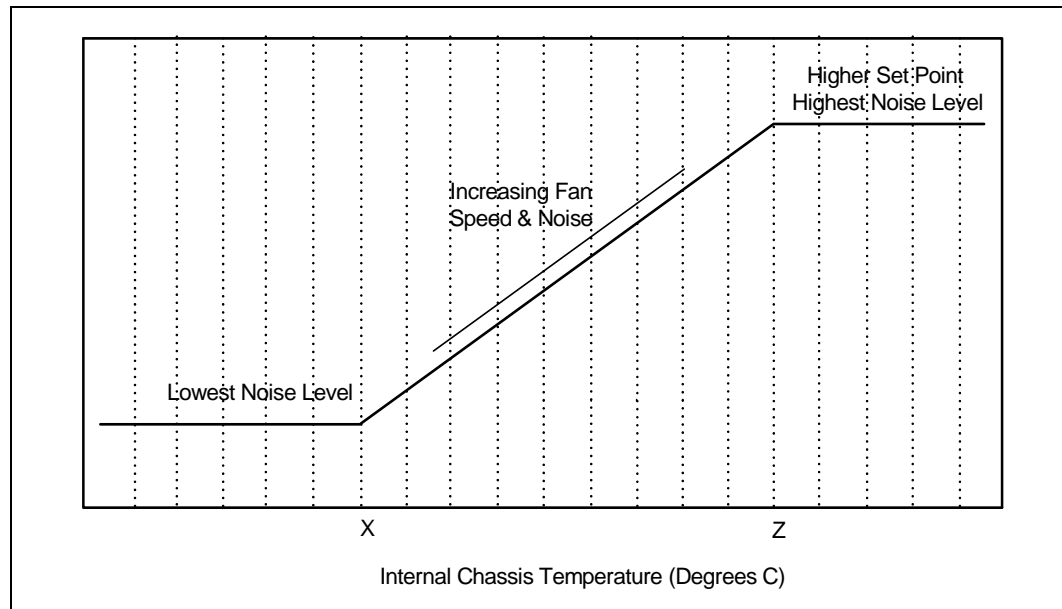
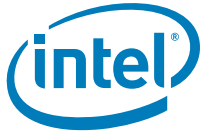

**Table 8-2. Fan Heatsink Power and Signal Specifications**

Boxed Processor Fan Heatsink Set Point (°C)	Boxed Processor Fan Speed	Notes
$X \leq 30$	When the internal chassis temperature is below or equal to this set point, the fan operates at its lowest speed. Recommended maximum internal chassis temperature for nominal operating environment.	1
$Z \geq 40$	When the internal chassis temperature is above or equal to this set point, the fan operates at its highest speed. Recommended maximum internal chassis temperature for worst-case operating environment.	-

**Notes:**

1. Set point variance is approximately  $\pm 1$  °C from fan heatsink to fan heatsink.



If the boxed processor fan heatsink 4-pin connector is connected to a 4-pin motherboard header and the motherboard is designed with a fan speed controller with PWM output (CONTROL see [Table 8-1](#)) and remote thermal diode measurement capability, the boxed processor will operate as follows:

As processor power has increased, the required thermal solutions have generated increasingly more noise. Intel has added an option to the boxed processor that allows system integrators to have a quieter system in the most common usage.

The 4th wire PWM solution provides better control over chassis acoustics. This is achieved by more accurate measurement of processor die temperature through the processor's Digital Thermal Sensors (DTS) and PECI. Fan RPM is modulated through the use of an ASIC located on the motherboard that sends out a PWM control signal to the 4th pin of the connector labeled as CONTROL. The fan speed is based on actual processor temperature instead of internal ambient chassis temperatures.

If the new 4-pin active fan heat sink solution is connected to an older 3-pin baseboard processor fan header, it will default back to thermistor controlled. Under thermistor controlled mode, the fan RPM is automatically varied based on the Tinlet temperature measured by a thermistor located at the fan inlet.

For more details on specific motherboard requirements for 4-wire based fan speed control, see the appropriate processor Thermal and Mechanical Design Guidelines (see [Section 1.2](#)).

## §