

Viterbi IP Core User Guide

Updated for Intel® Quartus® Prime Design Suite: **17.1**



UG-VITERBI | 2017.11.06

Latest document on the web: [PDF](#) | [HTML](#)



Contents

1 About the Viterbi IP Core.....	3
1.1 Intel® DSP IP Core Features.....	3
1.2 Viterbi IP Core Features.....	4
1.3 DSP IP Core Device Family Support.....	4
1.4 DSP IP Core Verification.....	5
1.5 Viterbi IP Core Release Information.....	5
1.6 Viterbi IP Core Performance and Resource Utilization.....	5
2 Viterbi IP Core Getting Started.....	9
2.1 Installing and Licensing Intel FPGA IP Cores.....	9
2.1.1 Intel FPGA IP Evaluation Mode.....	9
2.1.2 Viterbi IP Core Intel FPGA IP Evaluation Mode Timeout Behavior.....	12
2.2 IP Catalog and Parameter Editor.....	12
2.3 Generating IP Cores (Intel Quartus Prime Pro Edition).....	14
2.3.1 IP Core Generation Output (Intel Quartus Prime Pro Edition).....	15
2.4 Simulating Intel FPGA IP Cores.....	18
2.5 DSP Builder for Intel FPGAs Design Flow.....	18
3 Viterbi IP Core Functional Description.....	19
3.1 Decoder.....	19
3.2 Convolutional Encoder.....	19
3.3 Trellis Coded Modulation.....	19
3.3.1 Half-Rate Convolutional Codes.....	20
3.3.2 Trellis Decoder.....	22
3.3.3 About Converting Received Signals.....	23
3.3.4 Trellis Termination.....	25
3.3.5 Trellis Initialization	25
3.4 Viterbi IP Core Parameters.....	25
3.4.1 Architecture.....	25
3.4.2 Code Sets.....	28
3.4.3 Viterbi Parameters.....	28
3.4.4 Test Data.....	30
3.5 Viterbi IP Core Interfaces and Signals.....	31
3.5.1 Avalon-ST Interfaces in DSP IP Cores.....	31
3.5.2 Global Signals.....	32
3.5.3 Avalon-ST Sink Signals.....	32
3.5.4 Avalon Source-ST Signals.....	33
3.5.5 Configuration Signals.....	34
3.5.6 Status Signals.....	34
3.5.7 Viterbi IP Core Timing Diagrams.....	35
A Viterbi IP Core User Guide Document Archives.....	37
5 Document Revision History.....	38



1 About the Viterbi IP Core

Related Links

- [Introduction to Intel FPGA IP Cores](#)
Provides general information about all Intel FPGA IP cores, including parameterizing, generating, upgrading, and simulating IP cores.
- [Creating Version-Independent IP and Qsys Simulation Scripts](#)
Create simulation scripts that do not require manual updates for software or IP version upgrades.
- [Project Management Best Practices](#)
Guidelines for efficient management and portability of your project and IP files.
- [Viterbi IP Core User Guide Document Archives](#) on page 37
Provides a list of user guides for previous versions of the Viterbi IP core.

1.1 Intel® DSP IP Core Features

- Avalon® Streaming (Avalon-ST) interfaces
- DSP Builder for Intel® FPGAs ready
- Testbenches to verify the IP core
- IP functional simulation models for use in Intel-supported VHDL and Verilog HDL simulators



1.2 Viterbi IP Core Features

- High-speed parallel architecture:
 - Performance of over 250 megabits per second (Mbps)
 - Fully parallel operation
 - Optimized block decoding and continuous decoding
- Low to medium-speed, hybrid architecture:
 - Configurable number of add compare and select (ACS) units
 - Memory-based architecture
 - Wide range of performance; wide range of logic area
- Fully parameterized Viterbi decoder, including:
 - Number of coded bits
 - Constraint length
 - Number of soft bits
 - Traceback length
 - Polynomial for each coded bit
- Variable constraint length
- Trellis coded modulation (TCM) option

1.3 DSP IP Core Device Family Support

Intel offers the following device support levels for Intel FPGA IP cores:

- Advance support—the IP core is available for simulation and compilation for this device family. FPGA programming file (.poF) support is not available for Quartus Prime Pro Stratix 10 Edition Beta software and as such IP timing closure cannot be guaranteed. Timing models include initial engineering estimates of delays based on early post-layout information. The timing models are subject to change as silicon testing improves the correlation between the actual silicon and the timing models. You can use this IP core for system architecture and resource utilization studies, simulation, pinout, system latency assessments, basic timing assessments (pipeline budgeting), and I/O transfer strategy (data-path width, burst depth, I/O standards tradeoffs).
- Preliminary support—Intel verifies the IP core with preliminary timing models for this device family. The IP core meets all functional requirements, but might still be undergoing timing analysis for the device family. You can use it in production designs with caution.
- Final support—Intel verifies the IP core with final timing models for this device family. The IP core meets all functional and timing requirements for the device family. You can use it in production designs.

Table 1. DSP IP Core Device Family Support

Device Family	Support
Arria® II GX	Final
Arria II GZ	Final
<i>continued...</i>	



Device Family	Support
Arria V	Final
Intel Arria 10	Final
Cyclone® IV	Final
Cyclone V	Final
Intel Cyclone 10	Final
Intel MAX® 10 FPGA	Final
Stratix® IV GT	Final
Stratix IV GX/E	Final
Stratix V	Final
Intel Stratix 10	Advance
Other device families	No support

1.4 DSP IP Core Verification

Before releasing a version of an IP core, Intel runs comprehensive regression tests to verify its quality and correctness. Intel generates custom variations of the IP core to exercise the various parameter options and thoroughly simulates the resulting simulation models with the results verified against master simulation models.

1.5 Viterbi IP Core Release Information

Use the release information when licensing the IP core.

Table 2. Release Information

Item	Description
Version	17.1
Release Date	November 2017
Ordering Code	IP-VITERBI/HS (parallel architecture) IP-VITERBI/SS (hybrid architecture)

Intel verifies that the current version of the Quartus Prime software compiles the previous version of each IP core. Intel does not verify that the Quartus Prime software compiles IP core versions older than the previous version. The *Intel FPGA IP Release Notes* lists any exceptions.

Related Links

- [Intel FPGA IP Release Notes](#)
- [Errata for Viterbi IP core in the Knowledge Base](#)

1.6 Viterbi IP Core Performance and Resource Utilization

This typical expected performance uses different architectures and constraint length, L, combinations, and ACS units, A, and the Quartus Prime software. Performance largely depends on constraint length, L.



Hybrid Architecture

The typical expected performance for a hybrid Viterbi IP core uses the Quartus Prime software with the Arria V (5AGXFB3H4F40C4), Cyclone V (5CGXFC7D6F31C6), and Stratix V (5SGSMD4H2F35C2) devices and the following parameters:

- $v = 6 \times L$
- $softbits = 3$
- $N = 2$

where:

- v is the traceback length
- L is the constraint length
- N is the number of coded bits
- A is the number of ACS units

Table 3. Typical Performance

Parameters		Device	ALM	f _{MAX} (MHz)	Memory		Registers	
L	A				M10K	M20K	Primary	Secondary
5	1	Arria 10	401	383	--	3	422	40
5	1	Arria V	323	201	5	--	390	60
5	1	Cyclone V	324	172	5	--	390	53
5	1	Stratix V	316	432	--	5	388	44
7	1	Arria 10	521	370	--	4	559	50
7	1	Arria V	427	207	6	--	507	58
7	1	Cyclone V	427	185	6	--	507	74
7	1	Stratix V	417	438	--	6	506	51
7	2	Arria 10	622	363	--	4	670	51
7	2	Arria V	529	215	6	--	625	71
7	2	Cyclone V	532	180	6	--	625	74
7	2	Stratix V	502	408	--	6	625	56
7	4	Arria 10	835	366	--	4	885	101
7	4	Arria V	744	204	6	--	856	99
7	4	Cyclone V	746	173	6	--	856	100
7	4	Stratix V	652	382	--	6	856	82
9	1	Arria 10	932	343	--	9	970	88
	1	Arria V	792	190	11	--	927	90
9	1	Cyclone V	794	176	11	--	926	96
9	1	Stratix V	777	393	--	11	924	94
9	16	Arria V	2,118	188	17	--	2,743	309

continued...



Parameters		Device	ALM	f _{MAX} (MHz)	Memory		Registers	
L	A				M10K	M20K	Primary	Secondary
9	16	Cyclone V	2,119	163	17	--	2,744	275
9	16	Stratix V	1,887	348	--	17	2,738	198
9	2	Arria 10	1,029	363	--	9	1,091	74
9	2	Arria V	889	205	11	--	1,053	98
9	2	Cyclone V	889	180	11	--	1,053	96
9	2	Stratix V	883	377	--	11	1,053	115
9	4	Arria 10	1,240	298	--	9	1,321	87
9	4	Arria V	1,097	201	11	--	1,302	137
9	4	Cyclone V	1,096	159	11	--	1,302	126
9	4	Stratix V	1,021	390	--	11	1,302	119
9	8	Arria V	1,465	197	13	--	1,788	193
9	8	Cyclone V	1,465	163	13	--	1,789	191
9	8	Stratix V	1,398	351	--	13	1,790	154

Parallel Architecture

The typical expected performance for a parallel Viterbi IP core uses the Quartus Prime software with the Arria V (5AGXFB3H4F40C4), Cyclone V (5CGXFC7D6F31C6), and Stratix V (5SGSMD4H2F35C2) devices. The following parameters apply:

- $v = 6 \times L$
- $N = 2$

where:

- v is the traceback length
- L is the constraint length
- N is the number of coded bits

Table 4. Typical Performance

Parameters				Device	ALMs	f _{MAX} (MHz)	Memory		Registers	
softbits	L	Optimization	Best State Finder				M10K	M20K	Primary	Secondary
5	3	—	On	Arria 10	420	400	--	5	500	63
7	3	—	On	Arria 10	453	351	--	5	534	75
3	3	—	Off	Arria 10	396	423	--	5	473	39
5	3	—	Off	Arria 10	420	400	--	5	500	63
7	3	—	Off	Arria 10	453	351	--	5	534	75
3	7	Block	Off	Arria 10	1,454	354	--	3	817	154
3	7	Block	Off	Arria V	1,537	201	5	--	1,166	168
3	7	Block	Off	Cyclone V	1,544	149	5	--	1,167	88

continued...



Parameters				Device	ALMs	fMAX (MHz)	Memory		Registers	
softbits	L	Optimization	Best State Finder				M10K	M20K	Primary	Secondary
3	7	Block	Off	Stratix V	1,521	352	--	3	1,167	154
3	3	—	Off	Arria V	378	237	5	--	456	67
3	3	—	Off	Cyclone V	378	200	5	--	456	84
3	3	—	Off	Stratix V	378	405	--	5	455	45
5	3	—	Off	Arria V	397	210	5	--	483	68
5	3	—	Off	Cyclone V	397	188	5	--	484	81
5	3	—	Off	Stratix V	396	406	--	5	482	92
3	3	—	On	Arria V	378	237	5	--	456	67
3	3	—	On	Cyclone V	378	200	5	--	456	84
3	3	—	On	Stratix V	378	405	--	5	455	45
5	3	—	On	Arria V	397	210	5	--	483	68
5	3	—	On	Cyclone V	397	188	5	--	484	81
5	3	—	On	Stratix V	396	406	--	5	482	92
7	3	—	On	Arria V	424	219	5	--	518	82
7	3	—	On	Cyclone V	424	185	5	--	519	76
7	3	—	On	Stratix V	424	408	--	5	517	69
7	3	—	Off	Arria V	424	219	5	--	518	82
7	3	—	Off	Cyclone V	424	185	5	--	519	76
7	3	—	Off	Stratix V	424	408	--	5	517	69
7	4	—	Off	Arria V	424	219	5	--	518	82
7	4	—	Off	Cyclone V	424	185	5	--	519	76
7	4	—	Off	Stratix V	424	408	--	5	517	69
3	7	Continuous	Off	Arria 10	1,180	365	--	5	829	178
3	7	Continuous	Off	Arria V	1,222	187	9	--	1,137	250
3	7	Continuous	Off	Cyclone V	1,223	157	9	--	1,137	187
3	7	Continuous	Off	Stratix V	1,220	325	--	5	1,137	168



2 Viterbi IP Core Getting Started

1.

2.1 Installing and Licensing Intel FPGA IP Cores

The Intel Quartus Prime software installation includes the Intel FPGA IP library. This library provides many useful IP cores for your production use without the need for an additional license. Some Intel FPGA IP cores require purchase of a separate license for production use. The Intel FPGA IP Evaluation Mode allows you to evaluate these licensed Intel FPGA IP cores in simulation and hardware, before deciding to purchase a full production IP core license. You only need to purchase a full production license for licensed Intel IP cores after you complete hardware testing and are ready to use the IP in production.

The Intel Quartus Prime software installs IP cores in the following locations by default:

Figure 1. IP Core Installation Path

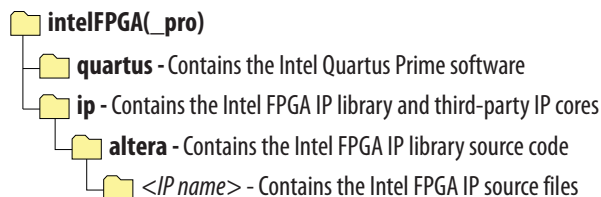

Table 5. IP Core Installation Locations

Location	Software	Platform
<drive>:\intelFPGA_pro\quartus\ip\altera	Intel Quartus Prime Pro Edition	Windows*
<drive>:\intelFPGA\quartus\ip\altera	Intel Quartus Prime Standard Edition	Windows
<home directory>:/intelFPGA_pro/quartus/ip/altera	Intel Quartus Prime Pro Edition	Linux*
<home directory>:/intelFPGA/quartus/ip/altera	Intel Quartus Prime Standard Edition	Linux

2.1.1 Intel FPGA IP Evaluation Mode

The free Intel FPGA IP Evaluation Mode allows you to evaluate licensed Intel FPGA IP cores in simulation and hardware before purchase. Intel FPGA IP Evaluation Mode supports the following evaluations without additional license:

Intel Corporation. All rights reserved. Intel, the Intel logo, Altera, Arria, Cyclone, Enpirion, MAX, Nios, Quartus and Stratix words and logos are trademarks of Intel Corporation or its subsidiaries in the U.S. and/or other countries. Intel warrants performance of its FPGA and semiconductor products to current specifications in accordance with Intel's standard warranty, but reserves the right to make changes to any products and services at any time without notice. Intel assumes no responsibility or liability arising out of the application or use of any information, product, or service described herein except as expressly agreed to in writing by Intel. Intel customers are advised to obtain the latest version of device specifications before relying on any published information and before placing orders for products or services.

*Other names and brands may be claimed as the property of others.

ISO
9001:2008
Registered



- Simulate the behavior of a licensed Intel FPGA IP core in your system.
- Verify the functionality, size, and speed of the IP core quickly and easily.
- Generate time-limited device programming files for designs that include IP cores.
- Program a device with your IP core and verify your design in hardware.

Intel FPGA IP Evaluation Mode supports the following operation modes:

- Tethered—Allows running the design containing the licensed Intel FPGA IP indefinitely with a connection between your board and the host computer. Tethered mode requires a serial joint test action group (JTAG) cable connected between the JTAG port on your board and the host computer, which is running the Intel Quartus Prime Programmer for the duration of the hardware evaluation period. The Programmer only requires a minimum installation of the Intel Quartus Prime software, and requires no Intel Quartus Prime license. The host computer controls the evaluation time by sending a periodic signal to the device via the JTAG port. If all licensed IP cores in the design support tethered mode, the evaluation time runs until any IP core evaluation expires. If all of the IP cores support unlimited evaluation time, the device does not time-out.
- Untethered—Allows running the design containing the licensed IP for a limited time. The IP core reverts to untethered mode if the device disconnects from the host computer running the Intel Quartus Prime software. The IP core also reverts to untethered mode if any other licensed IP core in the design does not support tethered mode.

When the evaluation time expires for any licensed Intel FPGA IP in the design, the design stops functioning. All IP cores that use the Intel FPGA IP Evaluation Mode time out simultaneously when any IP core in the design times out. When the evaluation time expires, you must reprogram the FPGA device before continuing hardware verification. To extend use of the IP core for production, purchase a full production license for the IP core.

You must purchase the license and generate a full production license key before you can generate an unrestricted device programming file. During Intel FPGA IP Evaluation Mode, the Compiler only generates a time-limited device programming file (*<project name>_time_limited.sof*) that expires at the time limit.



Figure 2. Intel FPGA IP Evaluation Mode Flow

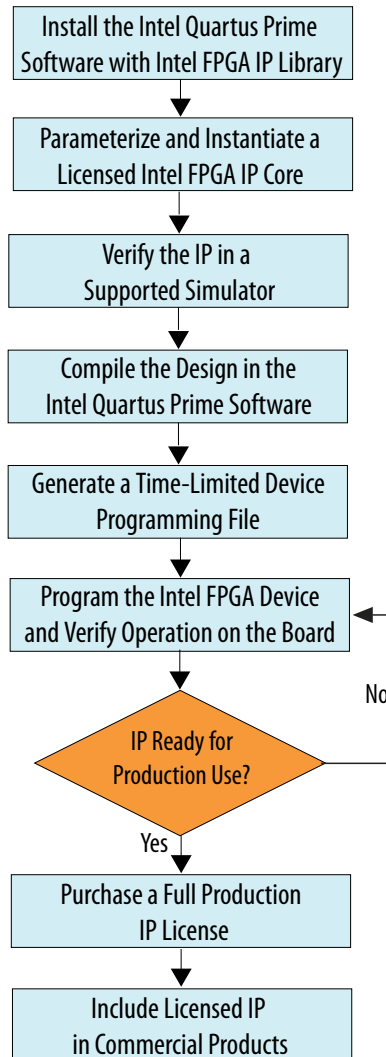

Note: Refer to each IP core's user guide for parameterization steps and implementation details.

Intel licenses IP cores on a per-seat, perpetual basis. The license fee includes first-year maintenance and support. You must renew the maintenance contract to receive updates, bug fixes, and technical support beyond the first year. You must purchase a full production license for Intel FPGA IP cores that require a production license, before generating programming files that you may use for an unlimited time. During Intel FPGA IP Evaluation Mode, the Compiler only generates a time-limited device programming file (*<project name>_time_limited.sof*) that expires at the time limit. To obtain your production license keys, visit the [Self-Service Licensing Center](#) or contact your local [Intel FPGA representative](#).

The [Intel FPGA Software License Agreements](#) govern the installation and use of licensed IP cores, the Intel Quartus Prime design software, and all unlicensed IP cores.



Related Links

- [Intel Quartus Prime Licensing Site](#)
- [Intel FPGA Software Installation and Licensing](#)

2.1.2 Viterbi IP Core Intel FPGA IP Evaluation Mode Timeout Behavior

All IP cores in a device time out simultaneously when the most restrictive evaluation time is reached. If there is more than one IP core in a design, the time-out behavior of the other IP cores may mask the time-out behavior of a specific IP core .

For IP cores, the untethered time-out is 1 hour; the tethered time-out value is indefinite. Your design stops working after the hardware evaluation time expires. The Quartus Prime software uses Intel FPGA IP Evaluation Mode Files (.ocp) in your project directory to identify your use of the Intel FPGA IP Evaluation Mode evaluation program. After you activate the feature, do not delete these files..

When the evaluation time expires the decbit signal goes low .

Related Links

[AN 320: OpenCore Plus Evaluation of Megafunctions](#)

2.2 IP Catalog and Parameter Editor

The IP Catalog displays the IP cores available for your project. Use the following features of the IP Catalog to locate and customize an IP core:

- Filter IP Catalog to **Show IP for active device family** or **Show IP for all device families**. If you have no project open, select the **Device Family** in IP Catalog.
- Type in the Search field to locate any full or partial IP core name in IP Catalog.
- Right-click an IP core name in IP Catalog to display details about supported devices, to open the IP core's installation folder, and for links to IP documentation.
- Click **Search for Partner IP** to access partner IP information on the web.

The parameter editor prompts you to specify an IP variation name, optional ports, and output file generation options. The parameter editor generates a top-level Intel Quartus Prime IP file (.ip) for an IP variation in Intel Quartus Prime Pro Edition projects.

The parameter editor generates a top-level Quartus IP file (.qip) for an IP variation in Intel Quartus Prime Standard Edition projects. These files represent the IP variation in the project, and store parameterization information.



Figure 3. IP Parameter Editor (Intel Quartus Prime Pro Edition)

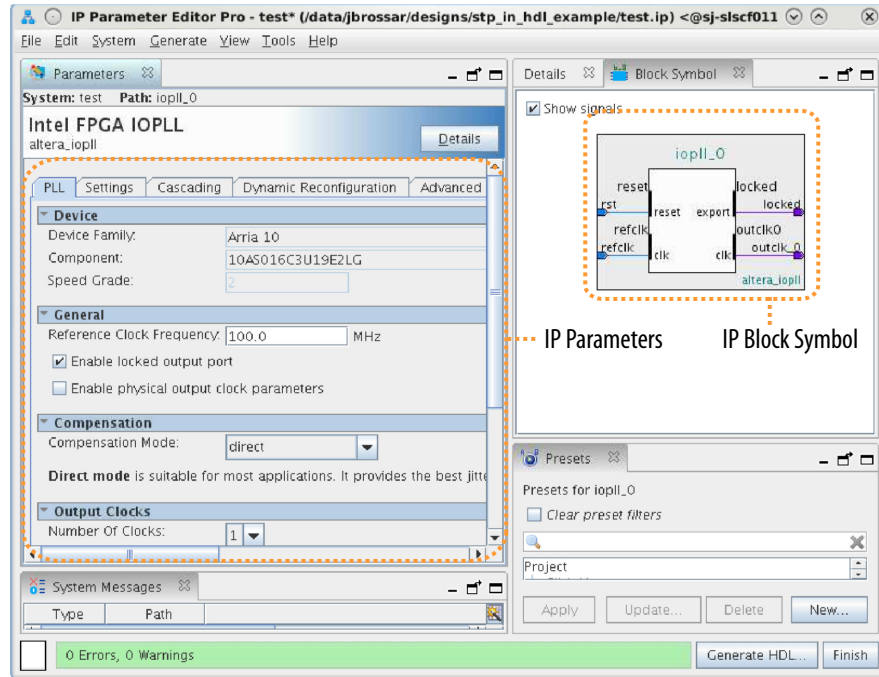
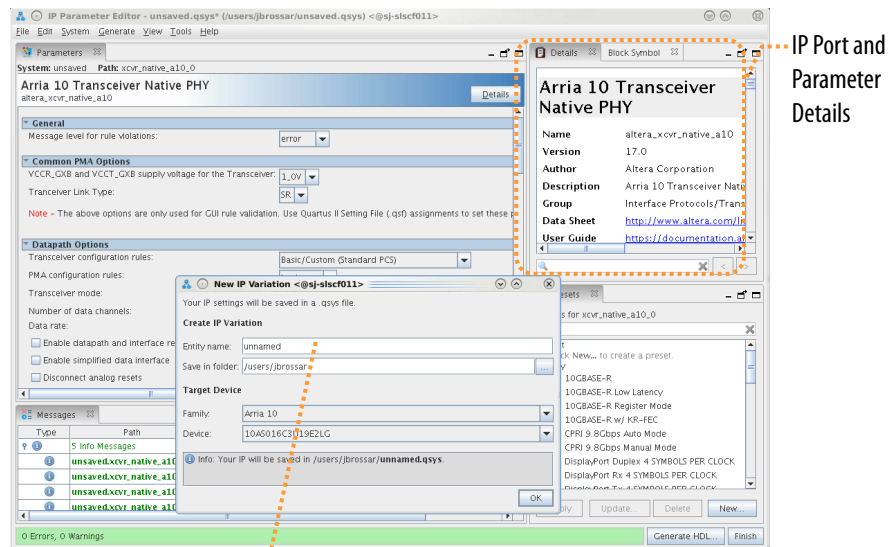

Figure 4. IP Parameter Editor (Intel Quartus Prime Standard Edition)



Specify IP Variation Name and Target Device

IP Port and Parameter Details

2.3 Generating IP Cores (Intel Quartus Prime Pro Edition)

Quickly configure Intel FPGA IP cores in the Intel Quartus Prime parameter editor. Double-click any component in the IP Catalog to launch the parameter editor. The parameter editor allows you to define a custom variation of the IP core. The parameter editor generates the IP variation synthesis and optional simulation files, and adds the .ip file representing the variation to your project automatically.

Figure 5. IP Parameter Editor (Intel Quartus Prime Pro Edition)

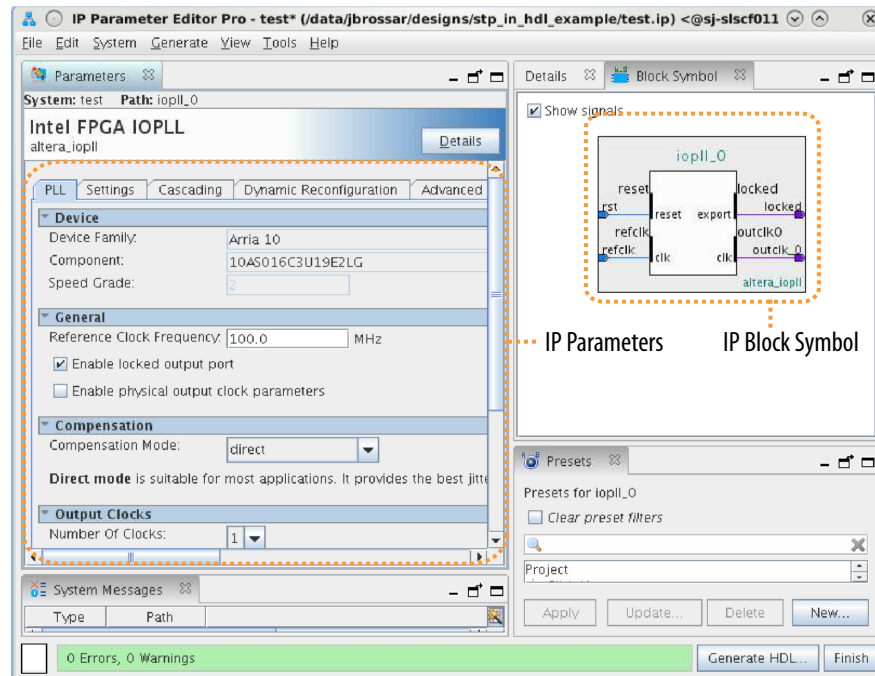

Follow these steps to locate, instantiate, and customize an IP core in the parameter editor:

1. Create or open an Intel Quartus Prime project (.qpf) to contain the instantiated IP variation.
2. In the IP Catalog (**Tools > IP Catalog**), locate and double-click the name of the IP core to customize. To locate a specific component, type some or all of the component's name in the IP Catalog search box. The New IP Variation window appears.
3. Specify a top-level name for your custom IP variation. Do not include spaces in IP variation names or paths. The parameter editor saves the IP variation settings in a file named *<your_ip>.ip*. Click **OK**. The parameter editor appears.
4. Set the parameter values in the parameter editor and view the block diagram for the component. The **Parameterization Messages** tab at the bottom displays any errors in IP parameters:
 - Optionally, select preset parameter values if provided for your IP core. Presets specify initial parameter values for specific applications.
 - Specify parameters defining the IP core functionality, port configurations, and device-specific features.
 - Specify options for processing the IP core files in other EDA tools.



Note: Refer to your IP core user guide for information about specific IP core parameters.

5. Click **Generate HDL**. The **Generation** dialog box appears.
6. Specify output file generation options, and then click **Generate**. The synthesis and simulation files generate according to your specifications.
7. To generate a simulation testbench, click **Generate > Generate Testbench System**. Specify testbench generation options, and then click **Generate**.
8. To generate an HDL instantiation template that you can copy and paste into your text editor, click **Generate > Show Instantiation Template**.
9. Click **Finish**. Click **Yes** if prompted to add files representing the IP variation to your project.
10. After generating and instantiating your IP variation, make appropriate pin assignments to connect ports.

Note: Some IP cores generate different HDL implementations according to the IP core parameters. The underlying RTL of these IP cores contains a unique hash code that prevents module name collisions between different variations of the IP core. This unique code remains consistent, given the same IP settings and software version during IP generation. This unique code can change if you edit the IP core's parameters or upgrade the IP core version. To avoid dependency on these unique codes in your simulation environment, refer to *Generating a Combined Simulator Setup Script*.

2.3.1 IP Core Generation Output (Intel Quartus Prime Pro Edition)

The Intel Quartus Prime software generates the following output file structure for individual IP cores that are not part of a Platform Designer system.

Figure 6. Individual IP Core Generation Output (Intel Quartus Prime Pro Edition)

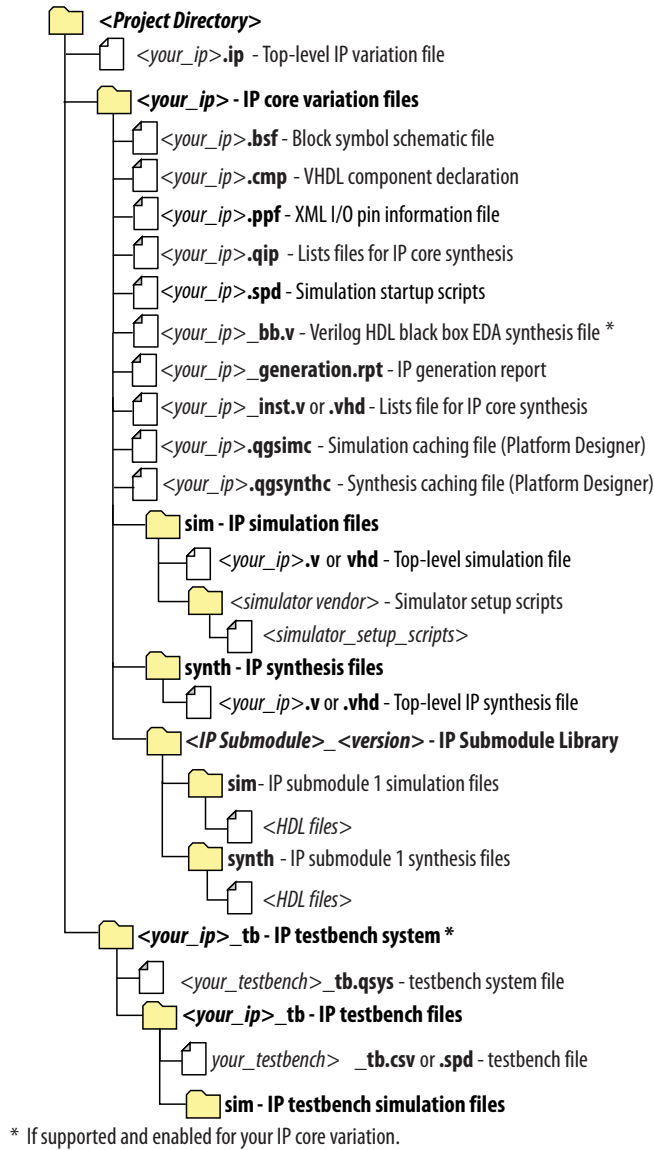

Table 6. Output Files of Intel FPGA IP Generation

File Name	Description
<your_ip>.ip	Top-level IP variation file that contains the parameterization of an IP core in your project. If the IP variation is part of a Platform Designer system, the parameter editor also generates a .qsys file.
<your_ip>.cmp	The VHDL Component Declaration (.cmp) file is a text file that contains local generic and port definitions that you use in VHDL design files.
<your_ip>_generation.rpt	IP or Platform Designer generation log file. Displays a summary of the messages during IP generation.

continued...



File Name	Description
<your_ip>.qgsimc (Platform Designer systems only)	Simulation caching file that compares the .qsys and .ip files with the current parameterization of the Platform Designer system and IP core. This comparison determines if Platform Designer can skip regeneration of the HDL.
<your_ip>.qgsynth (Platform Designer systems only)	Synthesis caching file that compares the .qsys and .ip files with the current parameterization of the Platform Designer system and IP core. This comparison determines if Platform Designer can skip regeneration of the HDL.
<your_ip>.qip	Contains all information to integrate and compile the IP component.
<your_ip>.csv	Contains information about the upgrade status of the IP component.
<your_ip>.bsf	A symbol representation of the IP variation for use in Block Diagram Files (.bdf).
<your_ip>.spd	Input file that ip-make-simscript requires to generate simulation scripts. The .spd file contains a list of files you generate for simulation, along with information about memories that you initialize.
<your_ip>.ppf	The Pin Planner File (.ppf) stores the port and node assignments for IP components you create for use with the Pin Planner.
<your_ip>_bb.v	Use the Verilog blackbox (_bb.v) file as an empty module declaration for use as a blackbox.
<your_ip>_inst.v or _inst.vhd	HDL example instantiation template. Copy and paste the contents of this file into your HDL file to instantiate the IP variation.
<your_ip>.regmap	If the IP contains register information, the Intel Quartus Prime software generates the .regmap file. The .regmap file describes the register map information of master and slave interfaces. This file complements the .sopcinfo file by providing more detailed register information about the system. This file enables register display views and user customizable statistics in System Console.
<your_ip>.svd	Allows HPS System Debug tools to view the register maps of peripherals that connect to HPS within a Platform Designer system. During synthesis, the Intel Quartus Prime software stores the .svd files for slave interface visible to the System Console masters in the .sof file in the debug session. System Console reads this section, which Platform Designer queries for register map information. For system slaves, Platform Designer accesses the registers by name.
<your_ip>.v <your_ip>.vhd	HDL files that instantiate each submodule or child IP core for synthesis or simulation.
mentor/	Contains a msim_setup.tcl script to set up and run a ModelSim simulation.
aldec/	Contains a Riviera*-PRO script rivierapro_setup.tcl to setup and run a simulation.
/synopsys/vcs /synopsys/vcsmx	Contains a shell script vcs_setup.sh to set up and run a VCS* simulation. Contains a shell script vcsmx_setup.sh and synopsys_sim.setup file to set up and run a VCS MX* simulation.
/cadence	Contains a shell script ncsim_setup.sh and other setup files to set up and run an NCSIM simulation.
/submodules	Contains HDL files for the IP core submodule.
<IP submodule>/	Platform Designer generates /synth and /sim sub-directories for each IP submodule directory that Platform Designer generates.



2.4 Simulating Intel FPGA IP Cores

The Intel Quartus Prime software supports IP core RTL simulation in specific EDA simulators. IP generation creates simulation files, including the functional simulation model, any testbench (or example design), and vendor-specific simulator setup scripts for each IP core. Use the functional simulation model and any testbench or example design for simulation. IP generation output may also include scripts to compile and run any testbench. The scripts list all models or libraries you require to simulate your IP core.

The Intel Quartus Prime software provides integration with many simulators and supports multiple simulation flows, including your own scripted and custom simulation flows. Whichever flow you choose, IP core simulation involves the following steps:

1. Generate simulation model, testbench (or example design), and simulator setup script files.
2. Set up your simulator environment and any simulation scripts.
3. Compile simulation model libraries.
4. Run your simulator.

2.5 DSP Builder for Intel FPGAs Design Flow

DSP Builder for Intel FPGAs shortens digital signal processing (DSP) design cycles by helping you create the hardware representation of a DSP design in an algorithm-friendly development environment.

This IP core supports DSP Builder for Intel FPGAs. Use the DSP Builder for Intel FPGAs flow if you want to create a DSP Builder for Intel FPGAs model that includes an IP core variation; use IP Catalog if you want to create an IP core variation that you can instantiate manually in your design.

Related Links

[Using MegaCore Functions chapter in the DSP Builder for Intel FPGAs Handbook.](#)

3 Viterbi IP Core Functional Description

3.1 Decoder

The Viterbi decoder can be a continuous or block decoder.

The continuous decoder processes a number of symbols greater than the traceback length. When the decoder traces back the number of bits (traceback length), it delivers output bits. This behavior changes when you assert the end of packet (EOP) signal. The decoder then switches to block decoding, starting traceback from the last symbol or state. The `tr_init_state` signal indicates the end state that starts the traceback operation. For block decoding Intel recommends you indicate the end state of the tail bits (usually zero) and set the `tb_type` signal to 1.

3.2 Convolutional Encoder

The viterbi IP core convolutional encoder.

Figure 7. Convolutional Encoder

$L = 5$, $N = 2$ and polynomials $GA = 19$ and $GB = 29$. GA in decimal is 19, which is equal to 10011 in binary. The most significant bit of the binary representation is the connection at the input data bit; the least significant bit (LSB) represents the connection at the end of the shift register chain. The XOR function implements the modulo-2 adding operation

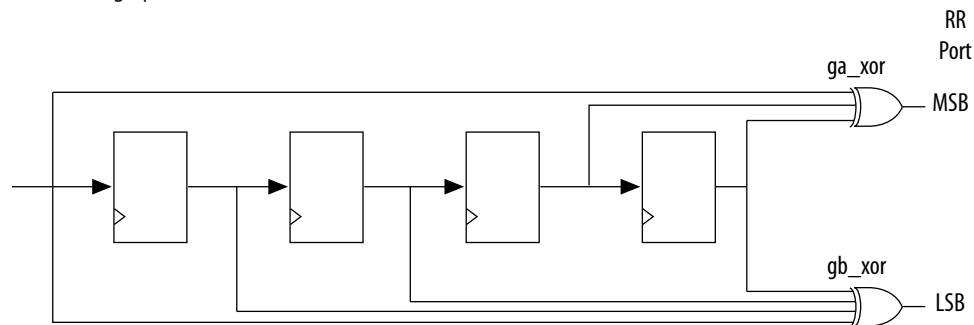

3.3 Trellis Coded Modulation

Trellis coded modulation (TCM) combines modulation and encoding processes to achieve better efficiency without increasing the bandwidth.

Bandwidth-constrained channels operate in the region $R/W > 1$, where R = data rate and W = bandwidth available. For such channels, digital communication systems use bandwidth efficient multilevel phase modulation. For example, phase shift keying (PSK), phase amplitude modulation (PAM), or quadrature amplitude modulation (QAM).

When you apply TCM to a bandwidth-constrained channel, you see a performance gain without expanding the signal bandwidth. An increase in the number of signal phases from four to eight requires approximately 4dB in additional signal power to maintain the same error rate. Hence, if TCM is to provide a benefit, the performance gain of the rate 2/3 code must overcome this 4dB penalty. If the modulation is an integral part of the encoding process and is designed in conjunction with the code to increase the minimum Euclidian distance between the pairs of coded signals, the loss from the expansion of the signal set is easily overcome and significant coding gain is achieved with relatively simple codes.

Any bandwidth-constrained system benefits from this technique, for example, satellite modem systems. The TCM Viterbi decoder only supports $N = 2$ (only mother code rates of 1/2).

3.3.1 Half-Rate Convolutional Codes

A 1/2 rate convolutional code encodes one information bit and leaves the second information bit uncoded.

Figure 8. Half-Rate Convolutional Code

With an eight-point signal constellation (e.g. eight-PSK), the two bits select one of the four subsets in the signal constellation. The remaining information bit selects one of the two points within each subset.

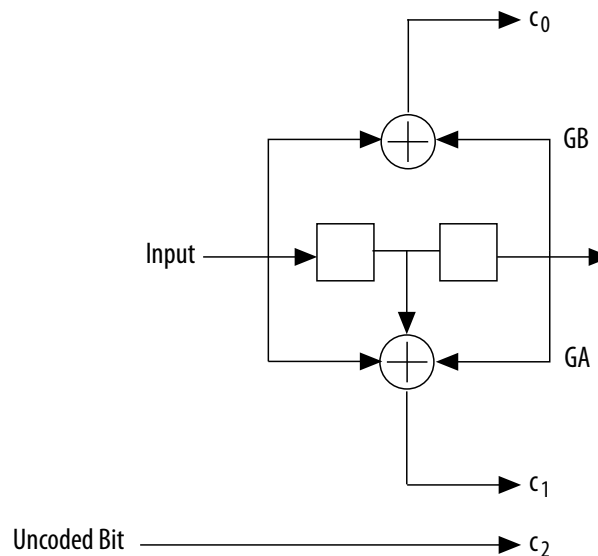
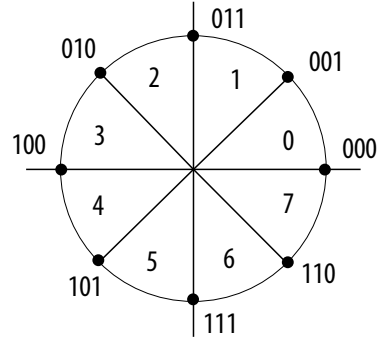



Figure 9. Mapping of Coded Bits and Sector Numbers

The specific mapping is not important. You can derive other mappings by permutating subsets in a way that preserves the main property of increased minimum distance among the subsets. However, you can create any other mapping, including symbol mappings for 8-PSK, 16-PSK and others.



If you create another mapping, you must correctly connect the branch metrics created outside the IP core to the input ports and correctly configure the polynomials GA and GB for the trellis generation.

Figure 10. Four-State Trellis

The four-state trellis is the trellis for the 1/2 rate convolution encoder with the addition of parallel paths in each transition to accommodate the uncoded bit c_2 . The decoder uses the coded bits (c_1, c_0) to select one of the four subsets that contain two signal points each. It uses the uncoded bit to select one of the two signal points within each subset.

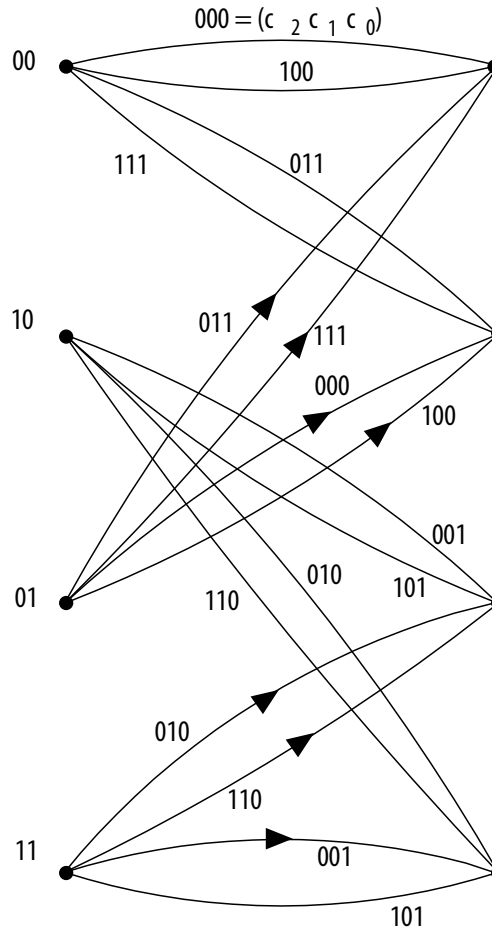

3.3.2 Trellis Decoder

The decoder processes an arriving symbol to obtain four branch metric values and a sector number. The branch metrics enter the Viterbi decoder in trellis mode and it obtains the encoded bit.

The encoder re-encodes this bit stream and the decoder uses the output of this encoder with the sector number information to retrieve the uncoded bit. The testbench implements all the logic. The wizard generates the branch metric values and sector number values, so you need no logic to create these values. The testbench reads the sector number when it needs it. It has no delay functionality nor rotation. The wizard-created data introduces no phase error so the phase is aligned. In a real system, you must calculate the phase. For a TCM code the BER block does not produce a meaningful output (`numerr`), because the BER block does not compute errors at the input for TCM codes.



Figure 11. Implementation of the Viterbi Decoder as a Trellis Decoder

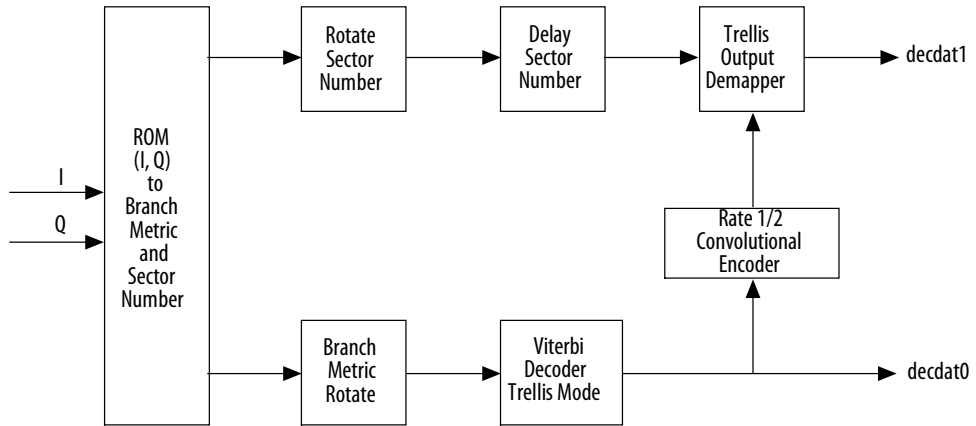

3.3.3 About Converting Received Signals

The Viterbi decoder calculates the distances to the nearest four symbol points as an unsigned number in the range 0...00 to 1...11 (number of softbits).

Where the range is equal to the radius of the symbol map. The decoder works with accumulative metrics (not Euclidean metrics), so the decoder inverts these distances (000 becomes 111; 001 becomes 110).

Figure 12. Conversion of Received Symbol into Four Branch Metrics and a Sector Number

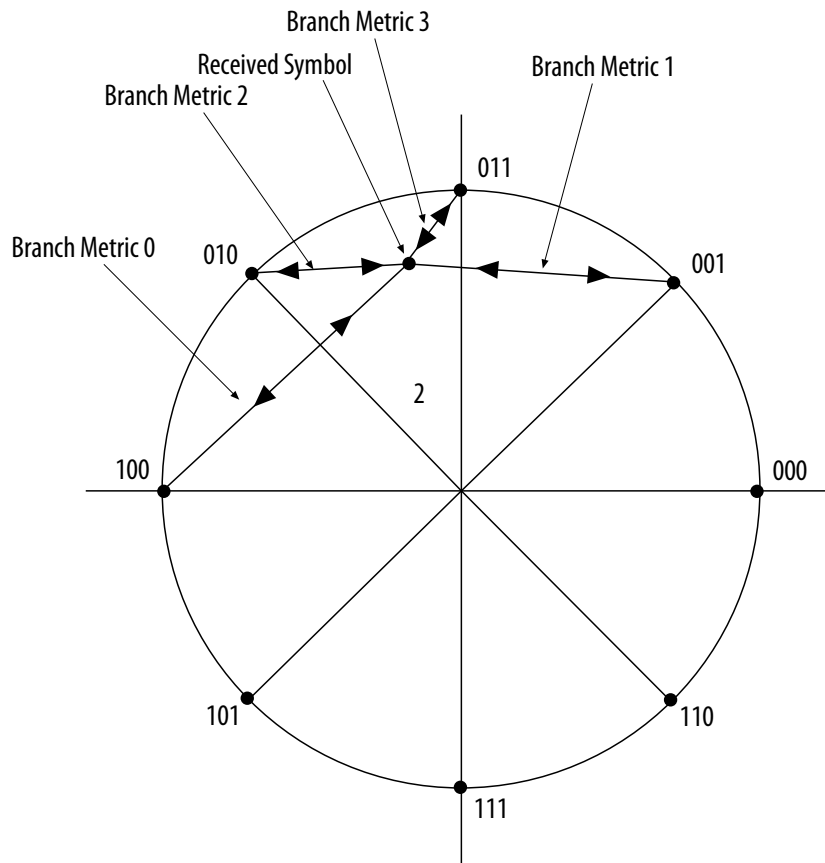

For example, consider a received symbol that lands in sector number 2 with the following distances to the four nearest symbol map points:

- 1111
- 1101
- 1011
- 0001

Where the distance of the radius for 4 softbits is 1111. The distances are inverted to obtain the following branch metrics:

- Branch metric 0 = 0000
- Branch metric 1 = 0010
- Branch metric 2 = 0100
- Branch metric 3 = 1110

The decoder uses the coded bits (c_1 , c_0) to select the branch metric number, which it uses to decide where to connect the branch metrics to the rr input of the Viterbi decoder. Branch metric 3 goes to the most significant bits (MSB) of rr ; branch metric 0 goes to the least significant bits (LSB) of rr .

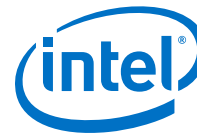

3.3.4 Trellis Termination

Block decoders must properly decode the last bits of the block and adapt to the convolutional encoder.

Tail-biting feeds the convolutional encoder with a block and terminates it with $(L - 1)$ unknown bits taken from the end of the block. Tail-biting sets the initial state of the convolutional encoder with the last $(L - 1)$ information bits. Tail-biting is decoded by replicating the block at the decoder or double feeding the block into the decoder. By decoding in the middle point, the trellis is forced into the state that is both the initial state and the end state. From the first decoding block, you can take the last half of the block; from the second decoded block (or second pass through the decoder), you can obtain the first half of the bits of the block.

Note: In tail-biting, the block size must be large enough to train the decoder, otherwise you may see BER loss.

Alternatively, if you initialize the convolutional encoder to zero, the initial state of the trellis is zero. The decoder knows the last $(L - 1)$ bits to the convolutional encoder. They bring the convolutional encoder to a known end state. The decoder then uses this information to set the end state of the trellis with `tr_init_state`, which is derived from the last $(L - 1)$ bits of the block in reverse order. For example, for a block that ends in: ...000101 If $L = 5$ and the decoder knows the last $(L - 1) = 4$ bits, it sets `tr_init_state` as 0101, which reversed and in binary is 1010, or 10 in decimal. The wizard generates `tr_init_state` as if it knows the last $(L - 1)$ bits of each block.

3.3.5 Trellis Initialization

The parallel decoder always starts its trellis from state zero for a new block.

However, the hybrid decoder allows you to set the initial state (usually zero) with `bm_init_state`. This signal ranges from 0 to $2(L - 1) - 1$, which are the trellis states. The `bm_init_value` signal initializes the state metric of the state indicated by `bm_init_state`. The decoder initializes all other states with zero. The appropriate value for this port is approximately $2^{(bmgwide - 2)}$ or any value between $2^{(N + softbits)}$ to $2^{(bmgwide - 1)}$. Continuous decoders never reset the state metrics, which creates a possible difference if the same block of data is sent several times. Initially, the decoder sets the state metrics so that the state metric for state 0 is 0, and all others infinity. For any subsequent blocks, the state metrics contain whatever they have when the previous block ends.

3.4 Viterbi IP Core Parameters

3.4.1 Architecture

Table 7. Architecture Parameters

Parameter	Value	Description
Viterbi architecture	Hybrid or Parallel	Selects the hybrid or parallel architecture.
BER	On or Off	Specifies the BER estimator option, refer to "BER Estimator" on page 3-7.
Node Sync	On or Off	Specifies the node synchronization option (only available when BER option is on).
Optimizations	None, Continuous, or Block	Specifies the optimization for the parallel decoder. if you select None you can turn on Best State Finder . However, to use less logic, turn off Best State Finder .

3.4.1.1 BER Estimator

The BER estimator option uses a re-encode and compare approach for estimating the number of errors in the input data.

Figure 13. BER Block Diagram

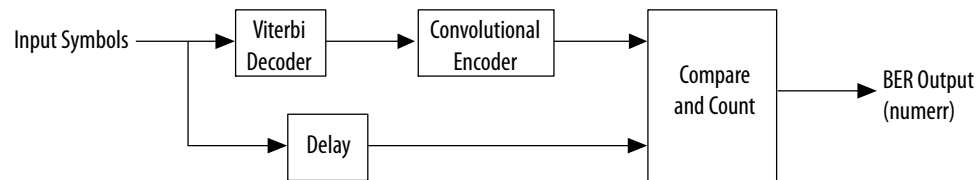

In cases where the signal-to-noise ratio is sufficiently high to allow the decoder to decode an error-free output, the BER estimation is very close to the actual channel BER. When the decoder is not decoding an error-free output, the estimated BER is higher and more random than the actual channel BER, which introduces a degree of uncertainty directly proportional to the output errors.

Note: For a TCM code, the BER block does not produce a meaningful output (`numerr`) because the BER block does not compute errors at the input for TCM codes.



Figure 14. Graph Comparing Actual BER with Estimated BER

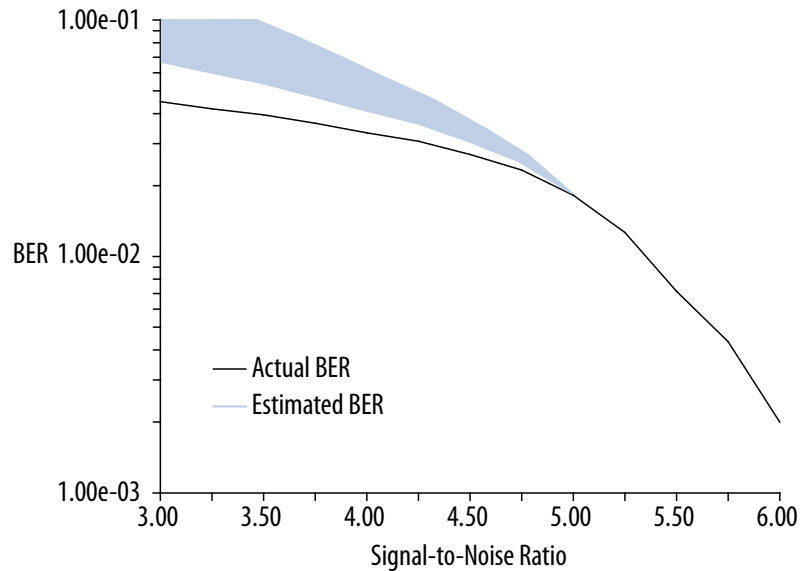

3.4.1.2 Node Synchronization

If you are not using external synchronization, you may not know the order of your N bits. The node synchronization option allows you to rotate the rr inputs until the decoder is in synchronization. To use node synchronization, you observe the BER and keep changing state_node_sync to rotate the rr inputs until you get the correct value for the BER.

Figure 15. Node Synchronization Block Diagram

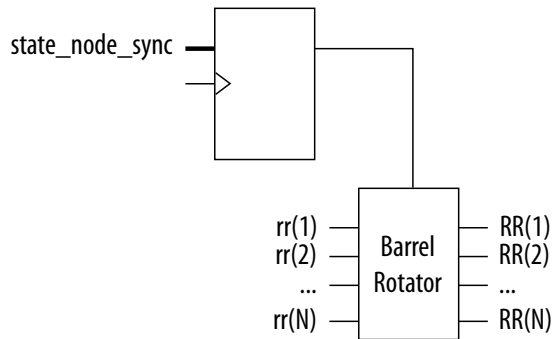

The following equation represents node synchronization:

$$RR[i] = rr[((state_node_sync + i - 1) \bmod N) + 1]$$

where i is 1 to N.

RR and rr are treated as an array of width N of busses softbits wide. The range of valid values for state_node_sync is 0 to (N - 1).



3.4.2 Code Sets

Table 8. Code Sets Parameters

Parameter	Value	Description
Number of Code Sets	1 to 8	The Viterbi IP core supports multiple code definitions. The multiple code set option allows up to eight code sets, where a code set comprises a code rate and associated generating polynomials.
Number of coded bits. (<i>N</i>)	2 to 7 (hybrid) 2 to 4 (parallel)	For every bit to be encoded, <i>N</i> bits are output. With the multiple code set option there are up to 5 different <i>N</i> parameters, which can be in any order. Valid only for Viterbi mode. For TCM mode only <i>N</i> = 2 is supported
Constraint length (<i>L</i>)	3 to 9	The constraint length. Defines the number of states in the convolutional encoder, where number of states = $2(L - 1)$. You can choose different values of <i>L</i> for each code set.
Decimal or Octal	-	Decimal or octal base representation for the generator polynomials. The design file representation is decimal, but you have the option of entering in either decimal or octal base.
Mode	V or T	Viterbi (V) or TCM mode (T).
GA, GB, GC, GD, GE, GF, GG	-	The generator polynomials. If you use the multiple code set option, the wizard enters a different set of polynomials in the respective <i>gi</i> group. The wizard provides default values that you can overwrite by any valid polynomial. (The wizard does not check whether the entered values are valid.) The parallel architecture uses only GA, GB, GC, and GD.

For multiple code sets, the first code definition corresponds to the first line and is selected with `sel_code` input = 0; the second line is selected with `sel_code` = 1; the third with `sel_code` = 2 and so on. For each code definition you can select *N*, the polynomials, the constraint length *L*, and the mode (Viterbi or TCM). You can mix different constraint lengths with different TCM and Viterbi modes. The test data, which the wizard creates, tests each of the code definitions. You can see these tests in the simulation with the testbench or if you look at the `block_period_stim.txt` file.

In hybrid mode, for constraint lengths of 3 and 4, the bitwidth of `tr_init_state` is 4, but the MegaCore function ignores the redundant higher bits.

For multiple constraint lengths, some of the last decoded bits may be incorrect, because of the Viterbi algorithm. To avoid this effect, give a lower BER, and reduce the probability of being on the wrong trellis path, set **Optimization** to **None** and turn on **Best State Finder**.

3.4.3 Viterbi Parameters

Parameter	Value	Description
Maximum constraint length (<i>L</i> _{MAX})	5 to 9 (hybrid) 3 to 9 (parallel)	The maximum constraint length <i>L</i> _{MAX} .
ACS Units (<i>A</i>)	1, 2, 4, 8, or 16	The number of ACS units, which adds a degree of parallelism (hybrid architecture only). The range of values available depends upon the value of maximum constraint length <i>L</i> _{MAX} .
<i>continued...</i>		



Parameter	Value	Description
Traceback (v)	8 (minimum)	The traceback length, which is the number of stages in the trellis that are traced back to obtain a decoded bit. It is typically set to $6 \times L$ for unpunctured codes, and up to $15 \times L$ for highly punctured codes.
Softbits (softbits)	1 to 16	The number of soft decision bits per symbol. When softbits is set to 1 bit, the decoder acts as a hard decision decoder, and still allows for erased symbols to be entered using the eras_sym input.
Bmgwide	-	The precision of the state metric accumulation. The parameter editor selects and displays the optimum value, which depends on N_{MAX} , L_{MAX} and, softbits.

3.4.3.1 Soft Symbol Input

The number of soft decision bits per symbol, *softbits*, represent $2^{softbits} - 1$ soft 0s and $2^{softbits} - 1$ soft 1s. The input values represent received signal amplitudes. If the input is in log-likelihood format, a transformation is required and you must use extra softbits to retain signal integrity. The decoder marks depunctured values separately. The decoder allows a hard-decision input when *softbits* = 1.

Table 9. Soft Symbol Input Representation

softbits = 3

Soft Symbol	Meaning
011	Strongest '0'
010	Strong '0'
001	Weak '0'
000	Weakest '0'
111	Weakest '1'
110	Weak '1'
101	Strong '1'
100	Strongest '1'

3.4.3.2 State Metrics

The Viterbi decoder state metrics are accumulative not Euclidean and are based on maximum metrics rather than minimum metrics.

As the metrics grow, normalize them to avoid overflow. When a normalization occurs the decoder subtracts $2^{(bmgwide - 1)}$ from all metrics and increases the normalization register by +1. The total metric value for the best path = (number of normalizations) $\times (2^{(bmgwide - 1)}) + bestmet$. The total metric value for the best path, the number of symbols processed, and the number of errors in the BER block indicate the quality of the channel and whether you have a suitable value for softbits. The output bestadd indicates the state that has the best metric.

3.4.3.3 Throughput Calculator

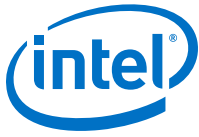

The throughput calculator uses the following equation:

$$\text{Hybrid throughput} = f_{\text{MAX}}/Z$$

where:

- — $Z = 10$, if $\log_2 C = 3$
- $Z = 2\log_2 C$, if $\log_2 C > 3$
- $\log_2 C = L_{\text{MAX}} - 2 - \log_2 A$
- L_{MAX} is the maximum constraint length
- A is ACS units
- Parallel throughput = f_{MAX}

3.4.3.4 Latency Calculator

The latency calculator gives you an approximate indication of the latency of your Viterbi decoder.

Latency is the number of clock cycles it takes the decoder to process r the data and output it. Latency is from the first symbol to enter the IP core (*sink_sop*) up to the first symbol to leave (*source_sop*). The latency depends on the parameters. For the precise latency, perform simulation. The latency calculator uses the following formula for the hybrid architecture:

$$\text{Number of clock cycles} = Z \times V$$

where:

- — V is the traceback length value that is in the input *tb_length*
- $Z = 10$, if $\log_2 C = 3$
- $Z = 2\log_2 C$, if $\log_2 C > 3$
- $\log_2 C = L_{\text{MAX}} - 2 - \log_2 A$, where A is ACS units

For the parallel architecture the number of clock cycles is approximately $4V$.

3.4.4 Test Data

Parameter	Description
Number of bits per block	The number of bits per block. The number of bits per block \times the number of blocks must be less than 50,000,000.
Signal to noise ratio (dB)	The signal to noise ratio, which must be between 1 and 100.
Number of blocks	The number of blocks. The number of bits per block \times the number of blocks must be less than 50,000,000.
Pattern A	Enter the puncturing pattern A.
Pattern B	Enter the puncturing pattern B.

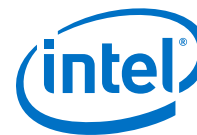

3.4.4.1 External Puncturing

Both parallel and hybrid architectures support external puncturing.

All punctured codes are based on a mother code of rate 1/2. For external depuncturing you must depuncture the received data stream external to the decoder and input the data into the decoder n symbols at a time.

Table 10. Puncturing Schemes

You can define these schemes and their rate. CA refers to the most significant (first transmitted bit, first received symbol); CB refers to the least significant (last transmitted bit, last received symbol)

Punctured Rate	Puncturing Scheme								
	Bit	Multiplier							
2/3	CA	1	0						
	CB	1	1						
3/4	CA	1	0	1					
	CB	1	1	0					
4/5	CA	1	0	0	0				
	CB	1	1	1	1				
5/6	CA	1	0	1	0	1			
	CB	1	1	0	1	0			
6/7	CA	1	0	0	1	0	1		
	CB	1	1	1	0	1	0		
7/8	CA	1	1	1	1	0	1	0	
	CB	1	0	0	0	1	0	1	

3.5 Viterbi IP Core Interfaces and Signals

The Viterbi Avalon-ST interface supports backpressure, which is a flow control mechanism, where a sink can indicate to a source to stop sending data.

The ready latency on the Avalon-ST input interface is 1.

You may achieve a higher clock rate by driving the source ready signal `source_rdy` of the Viterbi high, and not connecting the sink ready signal `sink_rdy`.

3.5.1 Avalon-ST Interfaces in DSP IP Cores

Avalon-ST interfaces define a standard, flexible, and modular protocol for data transfers from a source interface to a sink interface.

The input interface is an Avalon-ST sink and the output interface is an Avalon-ST source. The Avalon-ST interface supports packet transfers with packets interleaved across multiple channels.

Avalon-ST interface signals can describe traditional streaming interfaces supporting a single stream of data without knowledge of channels or packet boundaries. Such interfaces typically contain data, ready, and valid signals. Avalon-ST interfaces can also support more complex protocols for burst and packet transfers with packets



interleaved across multiple channels. The Avalon-ST interface inherently synchronizes multichannel designs, which allows you to achieve efficient, time-multiplexed implementations without having to implement complex control logic.

Avalon-ST interfaces support backpressure, which is a flow control mechanism where a sink can signal to a source to stop sending data. The sink typically uses backpressure to stop the flow of data when its FIFO buffers are full or when it has congestion on its output.

Related Links

[Avalon Interface Specifications](#)

3.5.2 Global Signals

Signal Name	Description
clk	The main system clock. The whole MegaCore function operates on the rising edge of clk.
reset	Reset. The entire decoder is asynchronously reset when reset is asserted high. The reset signal resets the entire system. You must deassert the reset signal synchronously with respect to the rising edge of clk.

3.5.3 Avalon-ST Sink Signals

Signal Name	Avalon-ST Name	Direction	Description
eras_sym[Nmax:1]	dat	Input	When asserted, eras_sym indicates an erased symbol. Both rr and eras_sym are Avalon-ST dat inputs
rr	dat	Input	Data input, which takes in n symbols, each softbits wide per clock. In TCM mode the rr width is (2N × softbits:1); in Viterbi mode the rr width is (nmax × softbits:1). Both rr and eras_sym are Avalon-ST dat inputs
sink_eop	eop	Input	End of packet (block) signal. sink_eop delineates the packet boundaries on the rr bus. When sink_eop is high, the end of the packet is present on the dat bus. sink_eop is asserted on the last transfer of every packet. This signal applies to block decoding only.
sink_rdy	ready	Output	Data transfer enable signal. The interface sink drives sink_rdy and controls the flow of data across the interface. sink_rdy behaves as a read enable from sink to source. When the source observes sink_rdy asserted on the clk rising edge, it can drive the Avalon-ST data interface signals and assert sink_val as early as the next clock cycle, if data is available. In the hybrid architecture, sink_rdy is asserted for one clock cycle at a time. If data is not available at the time, you have to wait for the next sink_rdy pulse.
sink_sop	sop	Input	Start of packet (block) signal. sop delineates the packet boundaries on the rr bus. When sink_sop is high, the start of the packet is present on the rr bus. sink_sop is asserted on the first transfer of every packet. This signal applies to block decoding only.
sink_val	val	Input	Data valid signal. sink_val indicates the validity of the data signals. sink_val is updated on every clock edge where sink_rdy is sampled asserted, and holds its current value along with the dat

continued...



Signal Name	Avalon-ST Name	Direction	Description
			bus where <code>sink_rdy</code> is sampled deasserted. When <code>sink_val</code> is asserted, the Avalon-ST data interface signals are valid. When <code>sink_val</code> is deasserted, the Avalon-ST data interface signals are invalid and you must disregard them. To determine whether new data has been received, the sink qualifies the <code>sink_val</code> signal with the previous state of the <code>sink_rdy</code> signal.
<code>sink_data</code>	<code>data</code>	Input	<p>In Qsys systems, this Avalon-ST-compliant data bus includes all the Avalon-ST input data and configuration signals. The signals are in the following order from MSB to LSB:</p> <ul style="list-style-type: none"> • <code>In</code> • <code>State_node_sync</code> • <code>Ber_clear</code> • <code>Sel_code</code> • <code>Tb_type</code> • <code>Tb_length</code> • <code>Tr_init_state</code> • <code>Bm_init_state</code> • <code>Bm_init_value</code> • <code>Eras_symRr</code>

3.5.4 Avalon Source-ST Signals

Signal	Avalon-ST Name	Direction	Description
<code>decbit</code>	<code>dat</code>	Output	The decbit signal contains output bits when <code>source_val</code> is asserted.
<code>source_eop</code>	<code>eop</code>	Output	End of packet (block) signal. if you select continuous optimization, this signal is left open and you must remove it from the testbench.
<code>source_rdy</code>	<code>ready</code>	Input	Data transfer enable signal. The sink interface drives <code>source_rdy</code> and uses it to control the flow of data across the interface. <code>ena</code> behaves as a read enable from sink to source. When the source observes <code>source_rdy</code> asserted on the <code>clk</code> rising edge it drives, on the following <code>clk</code> rising edge, the Avalon-ST data interface signals and asserts <code>source_val</code> . The sink captures the data interface signals on the following <code>clk</code> rising edge. If the source is unable to provide new data, it deasserts <code>source_val</code> for one or more clock cycles until it is prepared to drive valid data interface signals.
<code>source_sop</code>	<code>sop</code>	Output	Start of packet (block) signal. if you select continuous optimization, this signal is left open and you must remove it from the testbench.
<code>source_val</code>	<code>val</code>	Output	Data valid signal. The IP core asserts <code>source_val</code> high for one clock cycle, whenever there is a valid output on the <code>decbit</code> signal.
<code>out_data</code>	<code>data</code>	Output	<p>In Qsys systems, this Avalon-ST-compliant data bus includes all the Avalon-ST output data and configuration signals. The signals are in the following order from MSB to LSB:</p> <ul style="list-style-type: none"> • <code>Numerr</code> • <code>BestAdd</code> • <code>BestMet</code> • <code>Normalizations</code> • <code>Decbit</code>

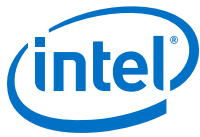

3.5.5 Configuration Signals

Signal Name	Description
ber_clear	Reset for the BER counter. Only for the BER block option.
bm_init_state[(L-1):1]	Specifies the state in which to initialize with the value from the <code>bm_init_value[]</code> bus. All other state metrics are set to zero. The IP core latches <code>bm_init_state</code> when <code>sink_sop</code> is asserted. Hybrid architecture only.
bm_init_value[(L-1):1]	Specifies the value of the metric that initializes the start state. All other metrics are set to 0. <code>bm_init_value</code> must be larger than $(L \times 2^{(softbits - 1)})$. The IP core latches <code>bm_init_value</code> when <code>sink_sop</code> is asserted. Hybrid architecture only.
sel_code[log2(Ncodes):1]	Selects the codeword. '0' selects the first codeword, '1' selects the second, and so on. The bus size increases according to the number of codes specified. The IP core latches <code>sel_code</code> when <code>sink_sop</code> is asserted.
state_node_sync[log2(Nmax):1]	Specifies the node synchronization rotation to <code>rr</code> . The IP core latches <code>state_node_sync</code> signal when <code>sink_sop</code> is asserted. Available only when you turn on Node Sync .
tb_length[]	Traceback length. The maximum width of <code>tb_length</code> is equal to the maximum value of parameter <code>v</code> . The IP core latches <code>tb_length</code> input when <code>sink_sop</code> is asserted. This IP core disables this signal if you select the continuous optimization: you must then remove it from the testbench. Not available for parallel architectures with block optimization.
tb_type	Parallel architectures only. Altera recommends that you set <code>tb_type</code> high always for future compatibility. In block decoding when <code>tb_type</code> is low, the decoder starts from state 0; when <code>tb_type</code> is high, the decoder uses the state specified in <code>tr_init_state[(L-1):1]</code> . For block decoding set <code>tb_type</code> high. The IP core latches <code>tb_type</code> when <code>sink_eop</code> is asserted. If you select None or Continuous optimization, the IP core connects this input to zero.
tr_init_state[(L-1):1]	Specifies the state to start the traceback from, when <code>tb_type</code> is asserted high. The IP core latches <code>tr_init_state</code> when <code>sink_eop</code> is asserted. If you select continuous optimization, this input is removed from the top level design and connected to zero in the inner core.

3.5.6 Status Signals



Signal	Description
bestadd[(L-1):1]	The best address state. The address corresponding to the best metric as it is being found by the best state finder. The metric of this state is shown in <code>bestmet</code> . If you select Continuous or None optimization and turn off best state finder, the IP core leaves this signal open. For parallel decoders, the IP core removes this signal.
bestmet[bmgwide:1]	The best metric. The <code>bestmet</code> signal shows the best state metric for every trellis step as the best state finder finds it. The state that contains this best metric is shown in <code>bestadd</code> . If you select Continuous or None for optimization and turn off best state finder, the IP core leave this signal open, For parallel decoders, the IP core removes this signal.
normalizations[8:1]	The normalizations bus indicates in real time the number of normalizations that occur since you activated <code>sink_sop</code> .
numerr[]	The <code>numerr</code> bus contains the number of errors detected during a block. The IP core updates it each time it detects an error, so you can see the location of individual errors. It is reset when <code>source_sop</code> asserted; it is valid two-clock cycles after <code>source_sop</code> . The wizard automatically sets the width of this bus. If you do not select a BER block, the IP cores leaves this signal open. Only available when you select the BER estimator option

3.5.7 Viterbi IP Core Timing Diagrams

Figure 16. Hybrid Decoder Input Timing Diagram

The `sink_rdy` signal is asserted for one clock cycle in every Z clock cycles. If the decoder becomes full because data is not being collected on the source side, it may deassert `sink_rdy` until it can accept new data. The decoder only accepts data, if `sink_rdy` is asserted.

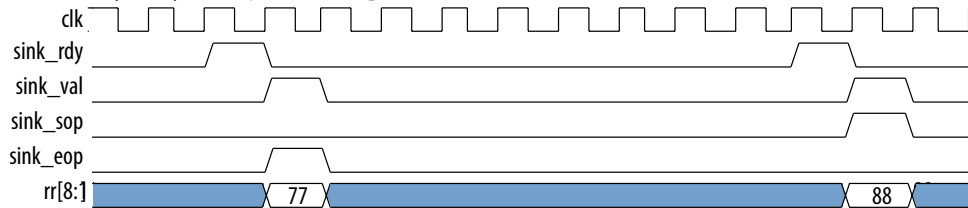

Figure 17. Parallel Decoder Input Timing Diagram

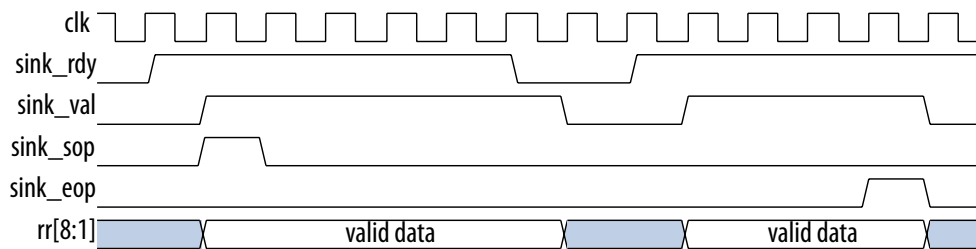

Figure 18. Output Timing - Example 1

The `source_val` signal is asserted initially for 8 or 16 clock cycles. It is then asserted for the number of clock cycles corresponding to the amount of remaining data, if `source_rdy` remains asserted. The typical ending of a block or packet in the Avalon-ST interface is on the source (Viterbi) to the sink (user) side connection.

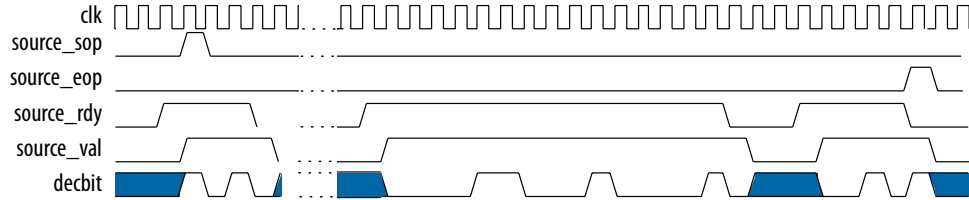

Figure 19. Output Timing - Example 2

With a different ending.

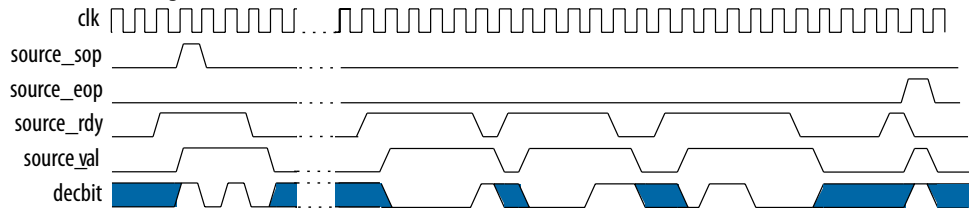
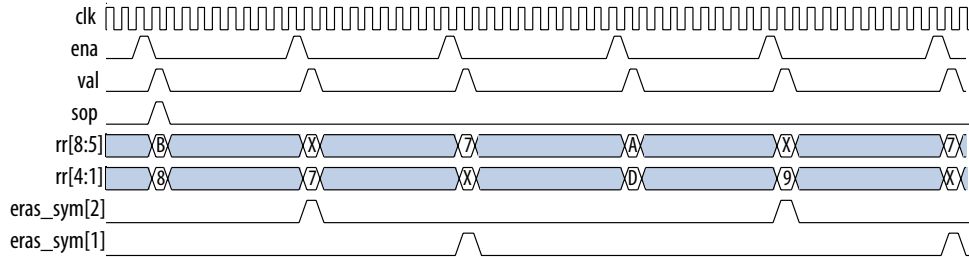

Figure 20. Depuncturing Timing Diagram

This depuncturing timing diagram shows `eras_sym` for the pattern 110110 (puncturing rate 3/4). By changing the `eras_sym` pattern you can implement virtually any depuncturing pattern you require.





A Viterbi IP Core User Guide Document Archives

If an IP core version is not listed, the user guide for the previous IP core version applies.

IP Core Version	User Guide
15.0	Viterbi IP Core User Guide v15.0
14.1	Viterbi IP Core User Guide v14.1

Intel Corporation. All rights reserved. Intel, the Intel logo, Altera, Arria, Cyclone, Enpirion, MAX, Nios, Quartus and Stratix words and logos are trademarks of Intel Corporation or its subsidiaries in the U.S. and/or other countries. Intel warrants performance of its FPGA and semiconductor products to current specifications in accordance with Intel's standard warranty, but reserves the right to make changes to any products and services at any time without notice. Intel assumes no responsibility or liability arising out of the application or use of any information, product, or service described herein except as expressly agreed to in writing by Intel. Intel customers are advised to obtain the latest version of device specifications before relying on any published information and before placing orders for products or services.

*Other names and brands may be claimed as the property of others.

**ISO
9001:2008
Registered**



5 Document Revision History

Viterbi IP Core User Guide revision history.

Date	Version	Changes
November 2017	2017.11.06	<ul style="list-style-type: none"> Changed descriptions of <code>tb_type</code> and <code>tb_length</code> signals Removed product ID and vendor ID. Added support for Intel Cyclone 10 devices
2014.12.15	14.1	<ul style="list-style-type: none"> Removed Arria 10 specific wizard comments Added final support for Arria 10 and MAX 10 devices
August 2014	14.0 Arria 10 Edition	<ul style="list-style-type: none"> Added support for Arria 10 devices. Added new <code>sink_data</code> and <code>out_data</code> bus description. Added Arria 10 generated files description. Removed table with generated file descriptions
June 2014	14.0	<ul style="list-style-type: none"> Removed support for Cyclone III and Stratix III devices. Added support for MAX 10 FPGAs Added instructions for using IP Catalog
November 2013	13.1	<ul style="list-style-type: none"> Removed support for the following devices: <ul style="list-style-type: none"> Arria Cyclone II HardCopy[®] II HardCopy III HardCopy IV Stratix Stratix II Stratix GX Stratix II GX Added full support for the following devices: <ul style="list-style-type: none"> Arria V Stratix V
November 2012	12.1	Added support for Arria V GZ devices.
May 2011	11.0	<ul style="list-style-type: none"> Updated support level to final support for Arria II GX, Arria II GZ, Cyclone III LS, and Cyclone IV GX devices. Updated support level to HardCopy Compilation for HardCopy III, HardCopy IV E, and HardCopy IV GX devices
December 2010	10.1	<ul style="list-style-type: none"> Added preliminary support for Arria II GZ devices. Updated support level to final support for Stratix IV GT devices.
July 2010	10.0	Added preliminary support for Stratix V devices.

Intel Corporation. All rights reserved. Intel, the Intel logo, Altera, Arria, Cyclone, Enpirion, MAX, Nios, Quartus and Stratix words and logos are trademarks of Intel Corporation or its subsidiaries in the U.S. and/or other countries. Intel warrants performance of its FPGA and semiconductor products to current specifications in accordance with Intel's standard warranty, but reserves the right to make changes to any products and services at any time without notice. Intel assumes no responsibility or liability arising out of the application or use of any information, product, or service described herein except as expressly agreed to in writing by Intel. Intel customers are advised to obtain the latest version of device specifications before relying on any published information and before placing orders for products or services.

*Other names and brands may be claimed as the property of others.

ISO
9001:2008
Registered