



Power Delivery Network (PDN) Tool User Guide



101 Innovation Drive
San Jose, CA 95134
www.altera.com

Document Version: 2.0
Document Date: March 2009

Copyright © 2009 Altera Corporation. All rights reserved. Altera, The Programmable Solutions Company, the stylized Altera logo, specific device designations, and all other words and logos that are identified as trademarks and/or service marks are, unless noted otherwise, the trademarks and service marks of Altera Corporation in the U.S. and other countries. All other product or service names are the property of their respective holders. Altera products are protected under numerous U.S. and foreign patents and pending applications, maskwork rights, and copyrights. Altera warrants performance of its semiconductor products to current specifications in accordance with Altera's standard warranty, but reserves the right to make changes to any products and services at any time without notice. Altera assumes no responsibility or liability arising out of the application or use of any information, product, or service described herein except as expressly agreed to in writing by Altera Corporation. Altera customers are advised to obtain the latest version of device specifications before relying on any published information and before placing orders for products or services.

UG-01036



Chapter 1. Power Delivery Network (PDN) Tool User Guide

| | |
|---|--------|
| Introduction | 1-1 |
| Application of the Tool | 1-1 |
| PDN Decoupling Methodology Review | 1-1 |
| PDN Circuit Topology | 1-1 |
| Setting Up the PDN Tool | 1-2 |
| Pre-Layout Instructions | 1-3 |
| Tabs in the PDN Tool | 1-9 |
| Summary | 1-19 |
| Document Revision History | Info-1 |
| How to Contact Altera | Info-1 |
| Typographic Conventions | Info-2 |

Introduction

PCB designers must estimate the number, value, and type of decoupling capacitors required to develop an efficient PCB decoupling strategy during the early design phase, without going through extensive pre-layout simulations. The Altera's Power Delivery Network (PDN) tool provides these critical pieces of information.

The PDN tool is a Microsoft Excel-based spreadsheet tool used to calculate an impedance profile based on user inputs. For a given power supply, the spreadsheet requires only basic design information, such as the board stackup, transient current information, and ripple specifications to come up with the impedance profile and the optimum number of capacitors to meet the desired impedance target. The results obtained through the spreadsheet tool are intended only as a preliminary estimate and not as a specification. For an accurate impedance profile, Altera® recommends a post-layout simulation approach using any of the available EDA tools, such as Sigriety PowerSI, Ansoft SIWave, Cadence Allegro PCB PI, etc.

This version of the PDN tool is a general purpose tool for helping with the PCB decoupling design. Altera has family-specific PDN tools for its FPGA devices that help reduce over-design in PCB decoupling by taking the effects of device-related parameters into consideration.



For the availability of the PDN tool that targets your device, refer to the Altera website at www.altera.com.

Application of the Tool

The purpose of the tool is to design a robust power delivery network by determining an optimum number, type, and value of decoupling capacitors required to meet the desired target impedance up to the target frequency. This spreadsheet tool is useful for exploring the various what-if scenarios during the early design phase, without extensive and time consuming pre-layout analysis.

PDN Decoupling Methodology Review

The PDN tool is based on a lumped equivalent model representation of the power delivery network topology. [Figure 1-1](#) shows a schematic representation of the circuit topology, modeled as part of the tool.

PDN Circuit Topology

For first order analysis, the voltage regulator module (VRM) can be simply modeled as a series-connected resistor and inductor, as shown in [Figure 1-1](#). At low frequencies, up to approximately 50 KHz, the VRM has a very low impedance and is capable of responding to the instantaneous current requirements of the FPGA. The ESR and ESL values can be obtained from the VRM manufacturer.

Beyond lower frequencies, the VRM impedance is primarily inductive, making it incapable of meeting the transient current requirement. The on-board discrete decoupling capacitors must provide the required low impedance from low to high frequencies, depending on the capacitor intrinsic parasitics (R_{cN} , C_{cN} , L_{cN}) and the capacitor mounting inductance (L_{mntN}). The interplanar capacitance between the power-ground planes typically has lower inductance than the discrete decoupling capacitor network, making it more effective at higher frequencies (tens of MHz). The effectiveness of the decoupling capacitors is limited by the PCB spreading inductance and the ball grid array (BGA) via inductance that a given capacitor encounters with respect to the FPGA. To simplify the circuit topology, the PDN tool models the distributed nature of PCB spreading, BGA inductance, and resistance with a single lumped inductor and resistor.

Figure 1-1. PDN Circuit Topology

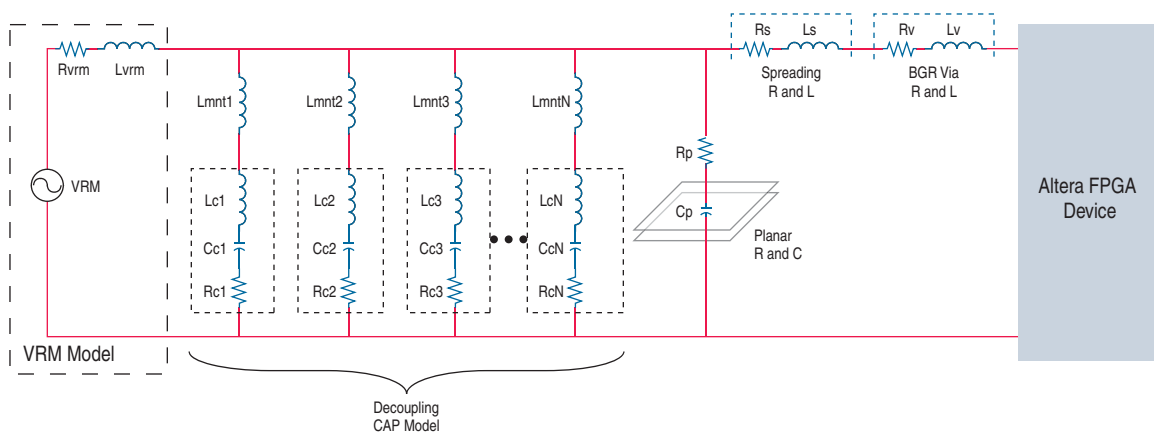

Setting Up the PDN Tool

Figure 1-2 shows the various tabs of the PDN tool spreadsheet.

Figure 1-2. Tabs in the PDN Tool

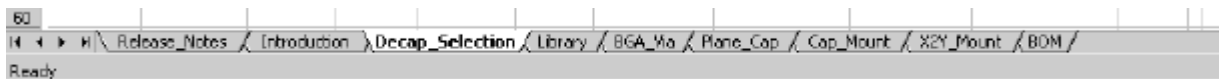

Table 1-1 describes the PDN tool tabs.

Table 1-1. Description of Tabs in PDN Tool (Sheet 1 of 2)

| Tab | Description |
|------------------------|--|
| Release Notes | This tab provides the legal disclaimers, the revision history of the tool, and the user agreement. |
| Introduction | This tab shows the schematic representation of the circuit that is modeled as part of the PDN tool. The tab also provides a brief Quick Start instruction on using the tool. |
| Decap Selection | This tab provides an interface to input the various parameters and observe the resultant impedance profile. This is the main user interface to the tool. |

Table 1-1. Description of Tabs in PDN Tool (Sheet 2 of 2)

| Tab | Description |
|------------------|---|
| Library | This tab points to various libraries (capacitor, dielectric materials, and so on) that are called by other tabs. You can change the default values listed as part of these libraries. |
| BGA Via | This tab provides an interface to calculate the BGA mounting inductance based on design-specific via parameters and the number of vias. |
| Plane Cap | This tab provides an interface to calculate the plane capacitance based on design-specific parameters. |
| Cap Mount | This tab provides an interface to input design-specific parameters for calculating the capacitor mounting inductance for two different capacitor orientations (Via on Side [VOS] and Via on End [VOE]). |
| X2Y Mount | This tab provides an interface to input design-specific parameters for calculating the capacitor mounting inductance for X2Y type capacitors. |
| BOM | The Bill of Materials (BOM) tab provides a summary of the final capacitor count required to meet the target impedance. |

The PDN tool is designed to provide an accurate estimate on the number and types of capacitors required to design a robust PDN, regardless of where you are in the design phase. The accuracy of the results is highly dependent on the user inputs for the various parameters.



You can explore the tool by following the **Quick Start** instructions listed in the **Introduction** tab.

In the pre-layout phase of the design cycle, when no specific information about the board stackup and board layout is known, you can follow the “[Pre-Layout Instructions](#)” on page 1-3 to explore the solution space when finalizing key design parameters, such as stackup, plane size, capacitor count, capacitor orientation, and so on.

If you have finalized the board stackup and have access to board database and layout information, you can step through the various tabs and enter the required information to arrive at a very accurate decoupling scheme.

Pre-Layout Instructions

In the pre-layout phase, you can ignore the **Plane Cap**, **Cap Mount**, **X2Y Mount**, and **BGA Via** tabs and go directly to the **Library** tab when you do not have layout information. [Figure 1-3](#) shows the fields located in the **Library** tab for entering the various parameters.

If available, enter the values shown in [Figure 1-3](#) in the **Library** tab. To use the default values, go directly to the **Decap Selection** tab to begin the analysis.

Figure 1-3. Library Tab

Library

Save Custom Restore Custom Restore Default

| Decoupling Cap [µF] | 0201 | | 0402 | | 0603 | | 0805 | | 1206 | | Custom | |
|---------------------|---------|----------|---------|----------|---------|----------|---------|----------|---------|----------|---------|----------|
| | ESR [Ω] | ESL [nH] | ESR [Ω] | ESL [nH] | ESR [Ω] | ESL [nH] | ESR [Ω] | ESL [nH] | ESR [Ω] | ESL [nH] | ESR [Ω] | ESL [nH] |
| 0.001 | 0.001 | 0.300 | 0.161 | 0.400 | 0.261 | 0.500 | 0.276 | 0.600 | 0.415 | 1.000 | 0.001 | 0.300 |
| 0.0022 | 0.003 | 0.300 | 0.175 | 0.400 | 0.186 | 0.500 | 0.173 | 0.600 | 0.263 | 1.000 | 0.001 | 0.300 |
| 0.0047 | 0.072 | 0.300 | 0.093 | 0.400 | 0.134 | 0.500 | 0.118 | 0.600 | 0.177 | 1.000 | 0.001 | 0.300 |
| 0.01 | 0.052 | 0.300 | 0.060 | 0.400 | 0.097 | 0.500 | 0.079 | 0.600 | 0.117 | 1.000 | 0.001 | 0.300 |
| 0.022 | 0.029 | 0.300 | 0.043 | 0.400 | 0.063 | 0.500 | 0.051 | 0.600 | 0.076 | 1.000 | 0.001 | 0.300 |
| 0.047 | 0.026 | 0.300 | 0.038 | 0.400 | 0.050 | 0.500 | 0.033 | 0.600 | 0.050 | 1.000 | 0.001 | 0.300 |
| 0.1 | 0.026 | 0.300 | 0.028 | 0.400 | 0.036 | 0.500 | 0.022 | 0.600 | 0.033 | 1.000 | 0.001 | 0.300 |
| 0.22 | 0.018 | 0.300 | 0.020 | 0.400 | 0.026 | 0.500 | 0.014 | 0.600 | 0.021 | 1.000 | 0.001 | 0.300 |
| 0.47 | 0.014 | 0.300 | 0.016 | 0.400 | 0.023 | 0.500 | 0.009 | 0.600 | 0.014 | 1.000 | 0.001 | 0.300 |
| 1 | 0.010 | 0.300 | 0.012 | 0.400 | 0.017 | 0.500 | 0.007 | 0.600 | 0.009 | 1.000 | 0.001 | 0.300 |
| 2.2 | 0.008 | 0.300 | 0.009 | 0.400 | 0.012 | 0.500 | 0.006 | 0.600 | 0.006 | 1.000 | 0.001 | 0.300 |
| 4.7 | 0.006 | 0.300 | 0.007 | 0.400 | 0.008 | 0.500 | 0.004 | 0.600 | 0.005 | 1.000 | 0.001 | 0.300 |
| User1 | 0.001 | 0.300 | 0.002 | 0.400 | 0.003 | 0.500 | 0.004 | 0.600 | 0.005 | 1.000 | 0.001 | 0.300 |
| User2 | 0.001 | 0.300 | 0.002 | 0.400 | 0.003 | 0.500 | 0.004 | 0.600 | 0.005 | 1.000 | 0.001 | 0.300 |
| User3 | 0.001 | 0.300 | 0.002 | 0.400 | 0.003 | 0.500 | 0.004 | 0.600 | 0.005 | 1.000 | 0.001 | 0.300 |
| User4 | 0.001 | 0.300 | 0.002 | 0.400 | 0.003 | 0.500 | 0.004 | 0.600 | 0.005 | 1.000 | 0.001 | 0.300 |

| Bulk Cap [µF] | Bulk | | | Custom | | |
|---------------|---------|----------|----------|---------|----------|----------|
| | ESR [Ω] | ESL [nH] | msl [nH] | ESR [Ω] | ESL [nH] | msl [nH] |
| 10 | 0.190 | 2.200 | 1500 | 0.000 | 2.300 | 1.700 |
| 22 | 0.167 | 2.200 | 1500 | 0.000 | 2.300 | 1.700 |
| 47 | 0.140 | 2.200 | 1500 | 0.000 | 2.300 | 1.700 |
| 100 | 0.060 | 2.300 | 1600 | 0.000 | 2.300 | 1.700 |
| 220 | 0.056 | 2.300 | 1600 | 0.000 | 2.300 | 1.700 |
| 330 | 0.049 | 2.300 | 1.700 | 0.000 | 2.300 | 1.700 |
| 470 | 0.049 | 2.300 | 1.700 | 0.000 | 2.300 | 1.700 |
| User5 | 0.030 | 2.300 | 1.700 | 0.000 | 2.300 | 1.700 |
| User6 | 0.030 | 2.300 | 1.700 | 0.000 | 2.300 | 1.700 |

| VRM | ESR [Ω] | | ESL [nH] | |
|----------|---------|----------|----------|----------|
| | ESR [Ω] | ESL [nH] | ESR [Ω] | ESL [nH] |
| Ignore | 10E-50 | 10E-50 | | |
| Linear | 0.001 | 30.00 | | |
| Switcher | 0.001 | 30.00 | | |
| Custom | 0.001 | 30.00 | | |

| Spreading R and L | R [Ω] | | Ls [nH] | |
|-------------------|--------|---------|---------|---------|
| | R [Ω] | Ls [nH] | R [Ω] | Ls [nH] |
| Ignore | 0 | 0 | | |
| Low | 0.0005 | 0.015 | | |
| Medium | 0.001 | 0.030 | | |
| High | 0.002 | 0.045 | | |
| Custom | 0.002 | 0.020 | | |

| Dielectric Material | Er | |
|---------------------|------|----|
| | Er | Er |
| FR4 | 4.50 | |
| Nelco 1000-6 | 4.70 | |
| Nelco 1000-13EPS | 3.40 | |
| Isola FR406 | 3.90 | |
| Isola FR408 | 3.70 | |
| Isola FR370HR | 4.54 | |
| Getek | 3.60 | |
| Rogers 4350B | 3.48 | |
| Custom | 3.90 | |

| QZY Cap | 0603 | | 0805 | | 1206 | | 1216 | |
|---------|---------|----------|---------|----------|---------|----------|---------|----------|
| | ESR [Ω] | ESL [nH] | ESR [Ω] | ESL [nH] | ESR [Ω] | ESL [nH] | ESR [Ω] | ESL [nH] |
| 0.001 | 0.095 | 0.054 | | | | | | |
| 0.0022 | 0.064 | 0.054 | | | | | | |
| 0.0047 | 0.041 | 0.054 | | | | | | |
| 0.01 | 0.030 | 0.054 | | | | | | |
| 0.022 | 0.020 | 0.054 | | | | | | |
| 0.047 | 0.017 | 0.054 | | | | | | |
| 0.1 | 0.010 | 0.054 | | | | | | |
| 0.22 | 0.007 | 0.054 | | | | | | |
| 0.33 | 0.008 | 0.054 | | | | | | |
| 0.47 | 0.008 | 0.054 | | | | | | |
| 1 | 0.005 | 0.054 | | | | | | |
| 0.10 | | | 0.007 | 0.056 | | | | |
| 0.22 | | | | | 0.008 | 0.054 | | |
| 0.47 | | | | | 0.006 | 0.054 | | |
| 1 | | | | | | | 0.003 | 0.054 |
| 0.1 | | | | | | | 0.01 | 0.054 |

Note: Default capacitor ESR and ESL values have been derived using Spice tools provided by various device vendors. These tools may be obtained directly from the vendor website, a few of which are listed here: www.lamtec.com, www.aus.com, www.murata.com, www.vishay.com, and www.papco.com among others. All other default values are typical values only. For best accuracy, default values may be overridden and saved with custom values determined by the user.

Notes to Figure 1-3:

The numbers in Figure 1-3 correspond to the following steps 1, 2, 3, 4, 5.

- (1) Enter the ESR, ESL, and L_{mount} values for the capacitors under the **Custom** field.
- (2) Enter the effective BGA via (loop) parasitics for the power supply being decoupled.
- (3) Enter the plane capacitance seen by the power/ground plane pair on the board for the power supply under Plane Cap.
- (4) Enter the VRM parasitics, if available, under the Custom row.
- (5) Enter the effective spreading inductance seen by the decoupling capacitors in the Custom row.

For more information on the **Decap Selection** tab, refer to “Decap Selection Tab” on page 1-16.

Figure 1-4 shows the various components (VRM, Spreading, BGA Via, and Plane Cap) of the PDN. In the **Decap Selection** tab, select the option most applicable for your design to begin the analysis for a given power supply. In this example, use the values populated in the **Custom** field in the **Library** tab, choose the **Custom** setting for the various parameters in the **Decap Selection** tab.

Figure 1-4. Options for the PDN Components

| Summary | Options | R (Ω) | L (nH) | C (μ F) |
|-----------|-----------|----------------|---------|--------------|
| VRM | Linear | 1.0E-03 | 1.0E+01 | N/A |
| Spreading | Low | 0.0005 | 0.0150 | N/A |
| BGA Via | Calculate | 0.0002 | 0.0261 | N/A |
| Plane Cap | Calculate | 0.0019 | N/A | 0.0630 |
| | Ignore | | | |
| | Calculate | | | |
| | Custom | | | |

The following information helps you accurately calculate the Z_{TARGET} for any power rail:

- The maximum transient current requirements for all devices in the system that are powered by the power rail under consideration. You can obtain this information from the manufacturers of the respective devices.
- 👉 Altera provides the PowerPlay Early Power Estimator (EPE) tool to estimate power consumption for all its FPGA and CPLD devices. You can download the EPE tool from the [PowerPlay Early Power Estimator Downloads](#) for your target Altera device. You can also use the Quartus® II PowerPlay Power Analyzer for an accurate estimation when the design is implemented.
- The maximum allowable AC ripple on the power rail as a percentage of the supply voltage. You can obtain this information from the power supply tolerance specifications of the devices being supplied by the power rail under consideration.
- Information regarding the Frequency Target (F_{TARGET}) to which the board PDN decoupling needs to be effective.

The upper limit of the frequency target for a given supply can be determined from the plot where the series combination of the plane spreading inductance and the BGA via inductance ($Z_{\text{SPREAD}} + Z_{\text{VIA}}$) profile crosses the Z_{TARGET} profile. Figure 1-5 shows the upper limit of frequency target calculation.

Figure 1-5. Frequency Target Calculation

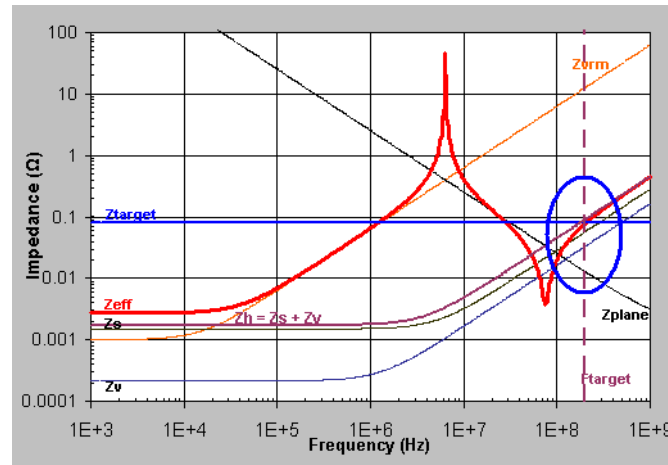

Decoupling using PCB capacitors becomes ineffective at high frequency. There is a cut-off frequency that you must decouple the power supply up to. This frequency ranges from tens of MHz to higher depending on the parameters, such as parasitic inductance, OPD capacitors, and ODC, of selected power rail. Altera has new family-specific PDN tools released that provide a suggested cut-off frequency, $F_{\text{EFFECTIVE}}$, as the guide line for PCB decoupling.

For information regarding the availability of the PDN tool that targets your device, refer to the Altera website at www.altera.com.

You must determine the proper F_{TARGET} in case the information regarding the PCB decoupling cut-off frequency is not available. You must decouple the power supply up to this frequency and expect the package and die parasitics to take over the decoupling for higher frequencies. For most supplies, this frequency is around 80 MHz for any power supply with reasonable Z_{TARGET} . Expect this frequency to be even lower, in the range of 50 MHz for the core power supply. Expect the device to take over at a frequency lower than the maximum frequency target that can be achieved on an optimally designed board (specifically for the Stratix® II GX, Stratix III, and Stratix IV device families).

After all this information is available, Z_{TARGET} can be calculated as:

Equation 1-1.

$$Z_{\text{TARGET}} = \left[\frac{\text{VoltageRail} \cdot \frac{\% \text{Ripple}}{100}}{\text{MaxTransientCurrent}} \right]$$

For example, to reliably decouple a 0.9-volt power rail up to 50 MHz with 5% AC ripple and a maximum current of 4 A, (assuming 50% of which is transient current), Z_{TARGET} can be calculated as:

Equation 1-2.

$$Z_{TARGET} = \left[\frac{(0.9)(0.05)}{4 \times 0.5} \right] = 0.0225$$

Figure 1-6 shows the Z_{TARGET} calculation from the PDN tool.

Figure 1-6. Z_{TARGET} Calculation

| Summary | Options | R (Ω) | L (nH) | C (μF) |
|-----------|-----------|---------|---------|--------|
| VRM | Linear | 1.0E-03 | 1.0E+01 | N/A |
| Spreading | Low | 0.0005 | 0.0150 | N/A |
| BGA Via | Calculate | 0.0027 | 0.3304 | N/A |
| Plane Cap | Calculate | 0.0019 | N/A | 0.0630 |

| Target Impedance | Units | Value | Legend |
|----------------------|-------|--------|---------|
| Supply Voltage (Min) | V | 1.1 | N/A |
| I max | A | 3 | N/A |
| Transient Current | % | 50 | N/A |
| Vripple (+/-) | % | 5 | N/A |
| Frequency target | MHz | 80 | Ftarget |
| Ztarget = ΔV / ΔI | Ω | 0.0367 | Ztarget |

To achieve a very low impedance profile (Z_{eff}) below the target impedance (Z_{TARGET}) up to the desired frequency, the power delivery network relies on the VRM, the on-board discrete decoupling capacitors, inter-plane capacitance, and a low value of spreading and mounting inductances.

Figure 1-7 shows one of the capacitor combinations that you can select to ensure that the effective impedance remains below 0.0225 Ω until the frequency range of interest (50 MHz). There are many combinations, but the ideal solution is to minimize the quantity and the type of capacitors required to achieve a flat impedance profile below the target impedance.

Figure 1-7. Decoupling Example

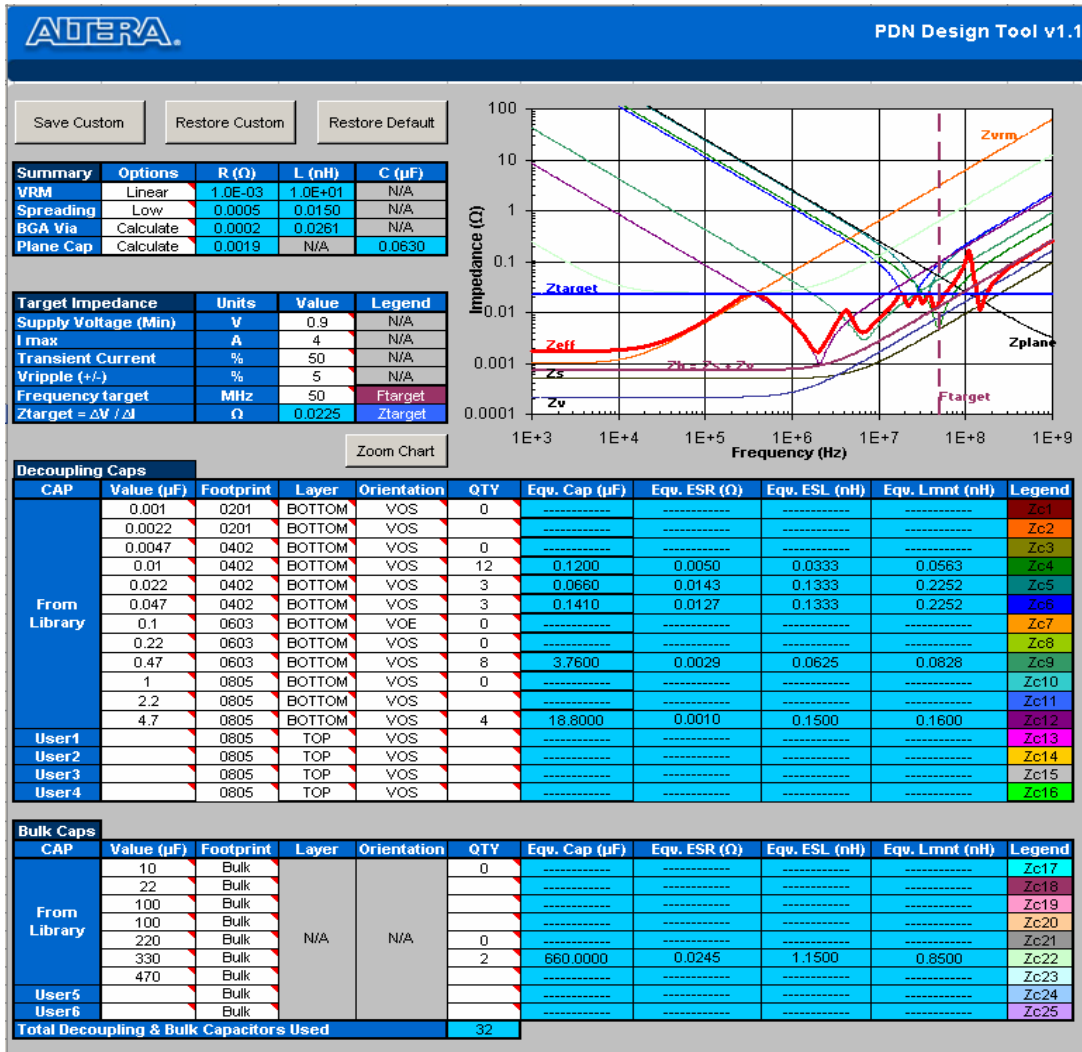

Tabs in the PDN Tool

This section describes the various tabs in detail. You can input design-specific information in the various tabs to arrive at a very accurate PDN profile for a given power supply.

Library Tab

Figure 1-8 shows the Library tab.

Figure 1-8. Library Tab

The screenshot shows the 'Library' tab of the PDN Design Tool v1.1. It contains several tables for configuring different components:

- Decoupling Cap (µ):** A large table with columns for capacitor values (0.001 to 1000) and rows for different capacitor types (0201, 0402, 0603, 0805, 1206, Custom). Each cell contains ESR (Ω), ESL (nH), and Lmnt (nH) values.
- Bulk Cap (µF):** A table with columns for capacitor values (10, 22, 47, 100, 220, 330, 470) and rows for Bulk and Custom types. Each cell contains ESR (Ω), ESL (nH), and Lmnt (nH) values.
- BGA Via & Plane Cap:** A small table with columns for BGA Via and Plane Cap, and rows for Custom and Default values. Each cell contains ESR (Ω), ESL (nH), and C (µF) values.
- VRM:** A table with columns for ESR (Ω) and ESL (nH), and rows for Ignore, Linear, Switcher, and Custom types.
- Spreading R and L:** A table with columns for Rs (Ω) and Ls (nH), and rows for Ignore, Low, Medium, High, and Custom types.
- Dielectric Material:** A table with columns for Er and rows for FR4, Nelco 4000-6, Nelco 4000-13EPS, Isola FR405, Isola FR408, Isola FR370HR, Getek, Rogers 4350B, and Custom types.
- X2Y Cap:** A table with columns for capacitor values (0.001, 0.0022, 0.0047, 0.01, 0.022, 0.047, 0.1) and rows for different capacitor types (0603, 0805, 1206, 1210). Each cell contains ESR (Ω), ESL (nH), and Lmnt (nH) values.

Note: Default capacitor ESR and ESL values have been derived using Spice tools provided by various device vendors. These tools may be obtained directly from the vendors website, a few of which are listed here: www.kemet.com, www.aus.com, www.murata.com, www.uskag.com, and www.yageo.com among others. All other default values are typical values only. For best accuracy, default values may be overridden and saved with custom values determined by the user.

This tab is divided into the following sections:

- Two-Terminal Decoupling Capacitors (High/Mid Frequency)
- X2Y Decoupling Capacitors (High/Mid Frequency) (High/Mid Frequency)
- Bulk Capacitors (Mid/Low Frequency)
- BGA Via and Plane Capacitance

- VRM Library
- Spreading R, L Parasitics
- Dielectric Material Library

You can change each of the default values listed in the respective sections to meet the specific requirements of your design.

Two-Terminal Decoupling Capacitors

The decoupling capacitors section contains the default ESR and ESL values for the various two-terminal capacitors in different footprints (0201, 0402, 0603, 0805, and 1206). You also can either modify the default values or enter your own custom values in the **Custom** field. If you use a non-two-terminal capacitor, such as an IDC-type capacitor, you must use the **Custom** field to enter the capacitor parasitics and the corresponding mounting inductance.

The decoupling capacitors section also provides the option for the user-defined capacitors (such as User1, ..., User4). You can define the ESR and ESL parasitics for the various footprints and enter the corresponding capacitor value in the **Decap Selection** tab. Choose the corresponding footprint when defining the capacitor values.

X2Y Decoupling Capacitors (High/Mid Frequency)

The decoupling capacitors section contains the default ESR and ESL values for the various X2Y capacitors in different footprints (0603, 0805, 1206, and 1210). You also can replace the default ESR and ESL values with your own custom values.

Bulk Capacitors

The bulk capacitors section contains the commonly used capacitor values for decoupling the power supply at mid/low frequencies. You can change the default values to reflect the parameters specific to the design.

BGA Via and Plane Capacitance

The BGA via and plane capacitance section provides an option to directly enter the values for effective via loop inductance under the BGA and plane capacitance during the pre-layout phase when no design-specific information is available.

If you have access to design-specific information, you can ignore this section and enter the design-specific information in the **Plane Cap** and **BGA Via** tabs that calculate the plane capacitance and the BGA via parasitics, respectively.

VRM Library

The VRM section lists the default values for both the linear and switcher regulators. You can change the VRM parasitics listed under the linear/switcher rows or add the custom parasitics for the VRM relevant to the design in the **Custom** field.

Spreading R, L Parasitics

The spreading R, L library provides various options for the default effective spreading inductance values that the decoupling capacitors see with respect to the FPGA based on the quality of the PDN design.

You can choose a **Low** value of effective spreading inductance if you have optimally designed your PDN. Optimum PDN design involves implementing the following design rules:

- PCB stackup that provides a wide solid power/ground sandwich for a given supply with a thin dielectric between the planes. This minimizes the current loop, which reduces the spreading inductance. The thickness of the dielectric material between the power/ground pair directly influences the amount of spreading/loop inductance that a decoupling cap can see with respect to the FPGA.
- Placing Capacitors closer to the FPGA from an electrical standpoint.
- Minimizing via perforations in the power/ground sandwich in the current path from the decoupling caps to the FPGA device.

Due to layout and design constraints, the PDN design might not be optimum; thus, you can choose either a **Medium** or **High** value of spreading R and L. You also can change the default values or use the **Custom** field listed in the library specific to the design.

Dielectric Material Library

The dielectric materials section lists the dielectric constant values for the various dielectric materials. These values are used in the plane capacitance calculations listed under the **Plane Cap** tab. You can change the values listed in this section.

If you change the default values listed in the various sections in the **Library** tab, you can save the changes by clicking **Save Custom**. You can restore the default library by clicking **Restore Default** located at the top right corner of the **Library** page. You also can restore the saved custom library by clicking **Restore Custom**.

Plane Cap Tab

The **Plane Cap** tab is used to calculate the distributed plane capacitance in microfarads (μf) that develops between the power/ground planes with a parallel plate capacitor equation. [Figure 1-9](#) shows the **Plane Cap** tab.

Figure 1-9. Plane Cap Tab

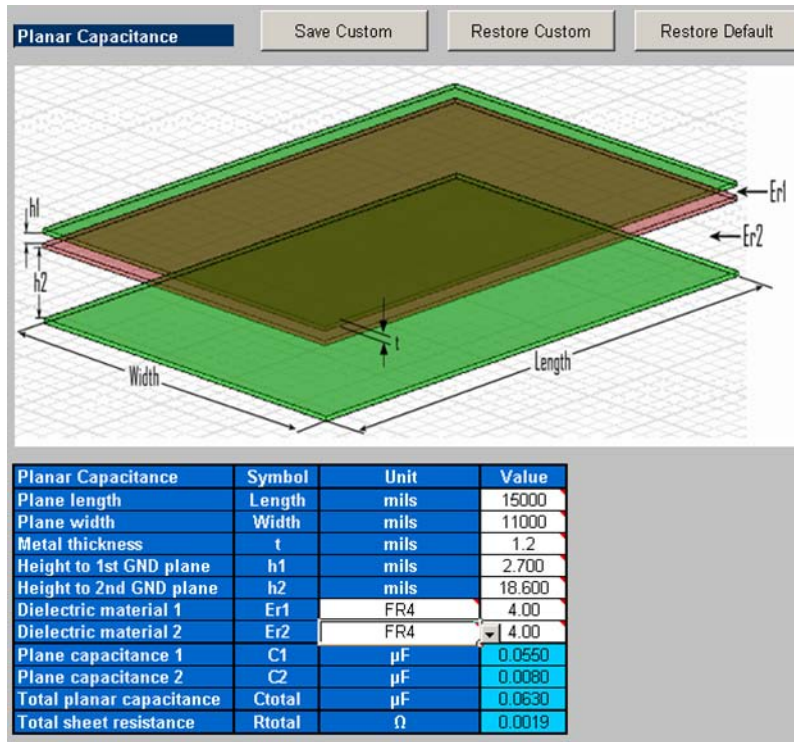

| Planar Capacitance | Symbol | Unit | Value |
|--------------------------|--------|---------------|--------|
| Plane length | Length | mils | 15000 |
| Plane width | Width | mils | 11000 |
| Metal thickness | t | mils | 1.2 |
| Height to 1st GND plane | h1 | mils | 2.700 |
| Height to 2nd GND plane | h2 | mils | 18.600 |
| Dielectric material 1 | Er1 | FR4 | 4.00 |
| Dielectric material 2 | Er2 | FR4 | 4.00 |
| Plane capacitance 1 | C1 | μF | 0.0550 |
| Plane capacitance 2 | C2 | μF | 0.0060 |
| Total planar capacitance | Ctotal | μF | 0.0630 |
| Total sheet resistance | Rtotal | Ω | 0.0019 |

You can enter the details specific to this design, for example plane dimensions, dielectric material, and plane configuration to calculate an accurate capacitance value. Similar to the **Library** tab, you can save custom values, restore custom values, and restore the default settings.

Cap Mount Tab

The **Cap Mount** tab, shown in Figure 1-10, is used to calculate the capacitor mounting inductance seen by the decoupling capacitor.

Figure 1-10. Cap Mount Tab

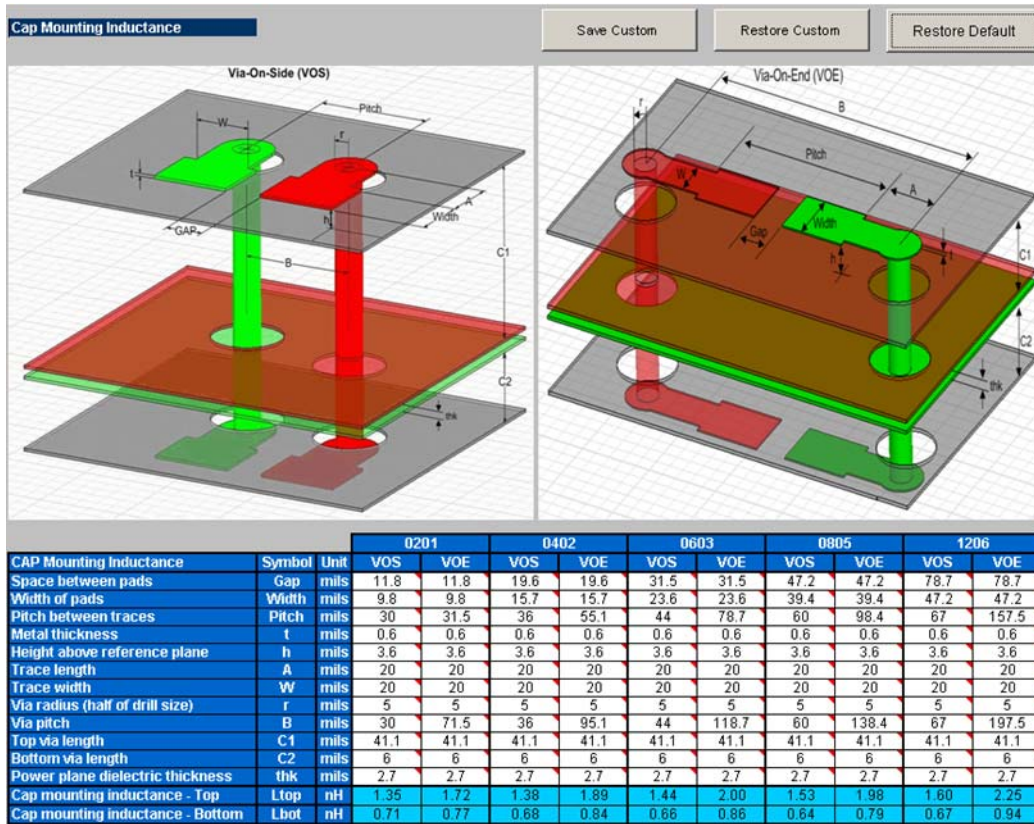

The capacitor mounting calculation is based on the assumption that the decoupling capacitor is a two-terminal device. The capacitor mounting calculation is applicable for any two-terminal capacitor with the following footprints: 0201, 0402, 0603, 0805, 1206, and so on. Based on the layout, you can enter all the information and the tool will provide a mounting inductance for a capacitor mounted on either the top or bottom layer of the board. Depending on the layout, you can choose between Via on End or Via on Side to achieve an accurate capacitor mounting inductance value.

If you plan to use a different footprint capacitor other than a regular two-terminal capacitor or X2Y capacitor for decoupling, you can skip using the **Cap Mount** tab and directly enter the capacitor parasitics and capacitor mounting inductance in the **Library** tab (under the **Custom** field in the **Decoupling Cap** section of the library). As with the other tabs, you can save the changes made to the tab, restore the changes, and restore the tab back to the default settings.

X2Y Mount Tab

The X2Y Mount tab, shown in Figure 1-11, is used to calculate the capacitor mounting inductance seen by the X2Y decoupling capacitor.

Figure 1-11. X2Y Mount Tab

Refer to figures below for details on dimensions

| X2Y CAP Mounting Inductance | Units | 0603 | 0805 | 1206 | 1210 |
|--|--------|-------|-------|--------|--------|
| Metal Thickness (t) | mils | 1.20 | 1.20 | 1.20 | 1.20 |
| Height above reference plane (h) | mils | 8.00 | 8.00 | 8.00 | 8.00 |
| Pad to Via trace width (W) | inches | 0.02 | 0.02 | 0.02 | 0.02 |
| Via radius (half of drill size) - r | mils | 6.00 | 6.00 | 6.00 | 6.00 |
| Center to Center Spacing (G1 - G2) Vias | mils | 90.00 | 80.00 | 120.00 | 160.00 |
| Center to Center Spacing (A - B) Vias | mils | 90.00 | 80.00 | 120.00 | 160.00 |
| Long Axis spacing between G1/G2 and A/B Vias | mils | 45.00 | 30.00 | 45.00 | 52.50 |
| | | | | | |
| Top Via Length (C1) | mils | 25.0 | 25.0 | 25.0 | 25.0 |
| Bottom via length (C2) | mils | 41.0 | 41.0 | 41.0 | 41.0 |
| Power plane dielectric thickness (thk) | mils | 4.0 | 4.0 | 4.0 | 4.0 |
| X2Y Cap mounting inductance - Top | nH | 0.300 | 0.247 | 0.318 | 0.401 |
| X2Y Cap mounting inductance - Bottom | nH | 0.373 | 0.304 | 0.399 | 0.462 |

User inputs in this tab are similar to those in the **Cap Mount** tab except that the VOE or VOS options are not required. If you plan to use a different footprint capacitor other than those available in the tool, you can skip using this tab and directly enter the capacitor parasitics and capacitor mounting inductance in the **Library** tab (replacing the preset value with your own data in the **X2Y Decoupling Cap** section). As with the other tabs, you have can save the changes made to the tab, restore the changes, and restore the tab back to the default settings.

BGA Via Tab

The **BGA Via** tab is used to calculate the vertical via loop inductance under the BGA pin field. Figure 1-12 shows the BGA Via tab.

Figure 1-12. BGA Via Tab

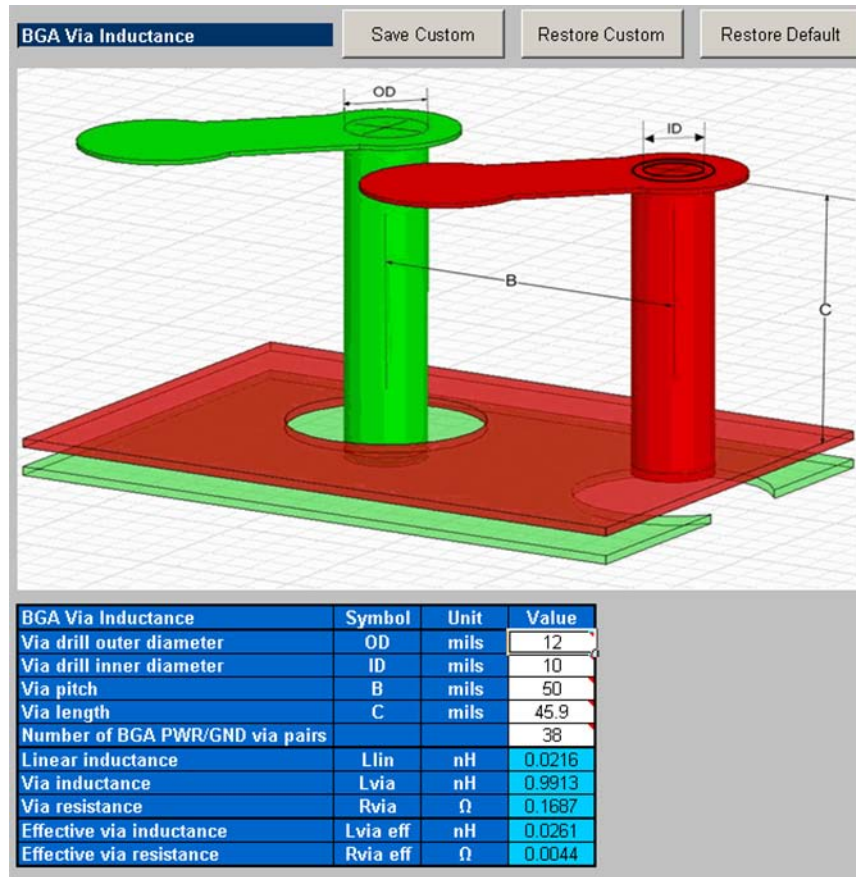

This tab takes the layout-specific information, such as the via drill diameter, via length, via pitch, and the number of power/ground via pairs under the BGA for an effective via loop inductance and resistance value.

Decap Selection Tab

The **Decap Selection** tab, shown in [Figure 1-13](#), is the main tab where you perform the analysis.

Figure 1-13. Decap Selection Tab

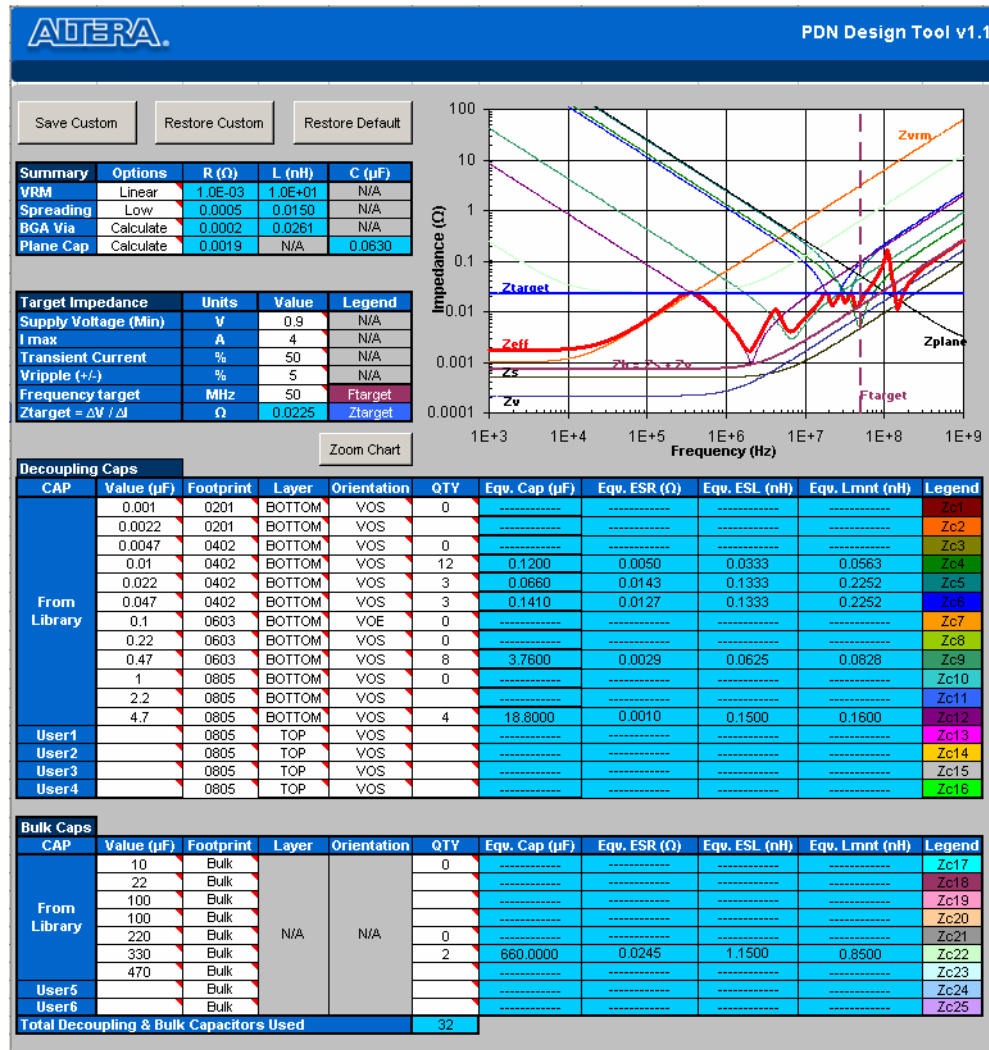

In the **Decap Selection** window, you can either enable or disable the following components of the PDN:

- VRM
- Spreading Parasitics
- BGA Via
- Plane Capacitance

VRM

You can choose either to **Ignore** or include the VRM parasitics for a **Linear**, **Switcher**, or **Custom** VRM parasitics.

Spreading Parasitics

Based on the design, you can select either a **Low**, **Medium**, **High**, or **Custom** value for the effective spreading R, L values that the decoupling capacitors see with respect to the FPGA. You can ignore the spreading inductance. Ignoring the spreading inductance leads to an optimistic result and is not an accurate representation of the impedance profile that the FPGA encounters.

The **Ignore** option helps you understand that the spreading inductance in combination with the BGA via inductance is the limiting factor from a PCB perspective to decouple the FPGA at high frequencies. Be careful when choosing the **Ignore** option while estimating a final capacitor count.

BGA Via

Based on the design, you can either **Ignore** the BGA via component or **Calculate** the effective via inductance based on the layout. If you are in the middle of layout, you can directly enter the effective loop R, L via parasitics in the **Library** tab and choose the **Custom** setting under **BGA Via** to include the via parasitics.

Plane Capacitance

Based on the design, you can either **Ignore** the interplanar capacitance between the power and ground plane, or **Calculate** the plane capacitance based on the layout. If you are in the middle of layout, you can directly enter the plane capacitance in the **Library** tab and choose the **Custom** setting under **Plane Cap** to include the plane capacitance parasitics.

The next section in the **Decap Selection** tab deals with target impedance calculation that was described earlier in the user guide.

The final section in the **Decap Selection** tab provides the ability to select the various high/mid frequency decoupling capacitors based on footprint, layer, and orientation to meet the target impedance you can choose X2Y type of capacitors in the Footprint column besides two-terminal capacitors. The capacitance value for the X2Y capacitor may be different from that of the two-terminal capacitor. A warning message of "Wrong Footprint" is displayed if you choose a wrong combination of capacitance and footprint. You can define custom capacitor values (such as User1, ..., User4) needed for high/mid frequency decoupling specific to the design. However, you cannot change the capacitor parasitics (ESR and ESL) in this tab. This can only be done in the **Library** tab.

You can change the parasitics of the bulk decoupling capacitors in the **Library** tab and define the mounting inductance specific to the design. You also can define custom capacitor values (such as User5, User6) for low/mid frequency decoupling specific to the design.

As provided in other tabs, you can save and restore the final capacitor count and other settings for a specific set of assumptions. You can also revert back to default settings.

BOM Tab

Figure 1-14 shows the BOM tab.

Figure 1-14. BOM Tab

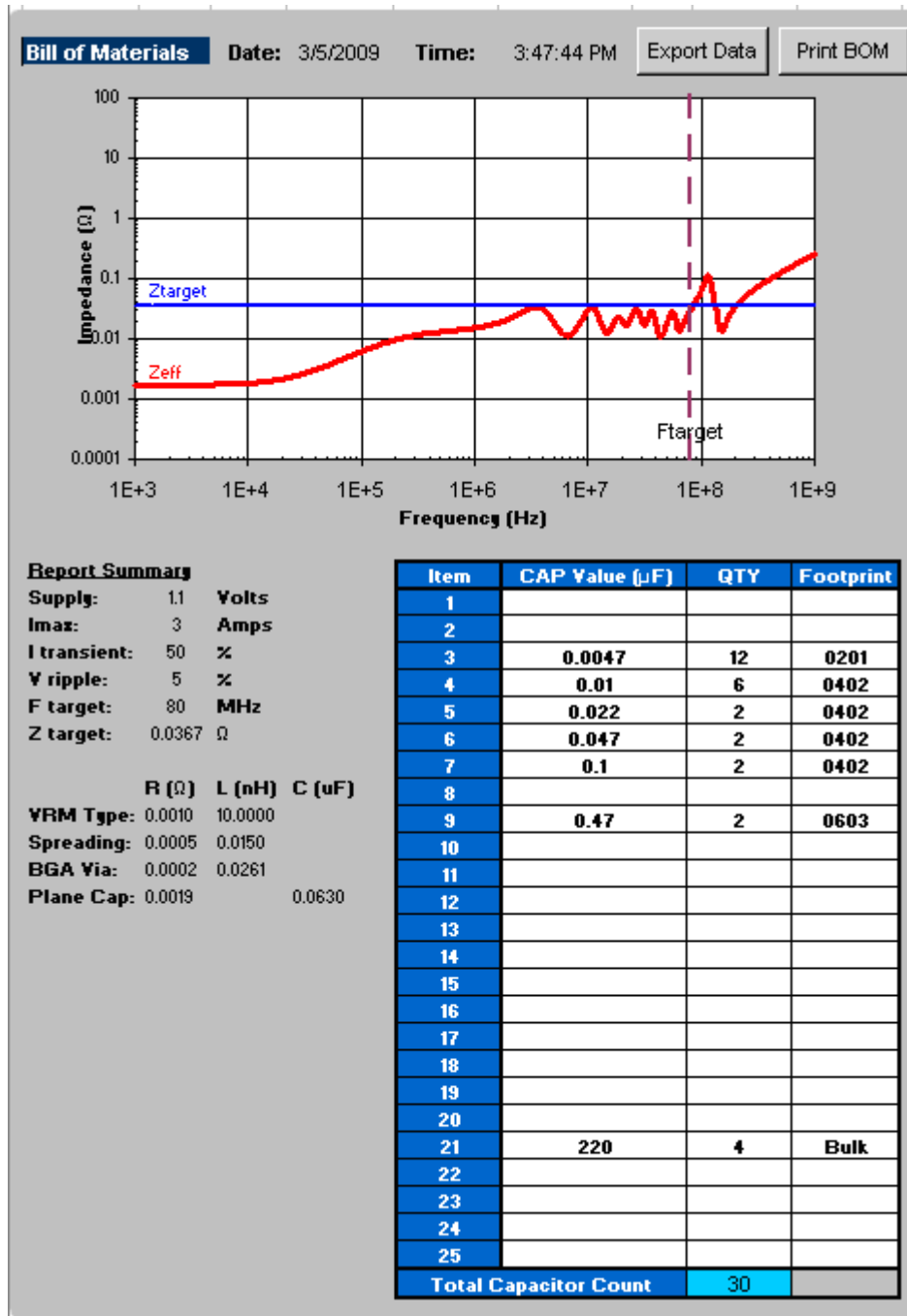

When the analysis is done, you can print the final Z_{eff} profile and capacitor count to achieve the profile by clicking **Print BOM** on the top right corner. It defaults to the default printer assigned on the **File** menu under **Print**. You can also export the data as an .xls file by clicking **Export Data**.

Summary

This user guide provides a brief overview of the various tabs in the PDN tool. You can quickly and accurately design a robust PDN by calculating an optimum number of capacitors that meet the target impedance requirements for a given power supply.

Document Revision History

The table below displays the revision history for the chapters in this User Guide.

| Date | Document Version | Changes Made |
|------------|------------------|---|
| March 2009 | 2.0 | <ul style="list-style-type: none"> ■ Added X2Y Mount information. ■ Added X2Y Decoupling Capacitors information. ■ Added PDN Decoupling Methodology Review section. ■ Updated PDN Circuit Topology section. ■ Updated Pre-Layout Instructions section. ■ Updated graphics. ■ Converted to the 8.5 × 11 template. |
| April 2008 | 1.0 | Initial release. |

How to Contact Altera

For the most up-to-date information about Altera® products, refer to the following table.





| Contact (1) | Contact Method | Address |
|--|----------------|--|
| Technical support | Website | www.altera.com/support |
| Technical training | Website | www.altera.com/training |
| | Email | custrain@altera.com |
| Product literature | Website | www.altera.com/literature |
| Non-technical support (General) | Email | nacomp@altera.com |
| Non-technical support (Software Licensing) | Email | authorization@altera.com |

Note to table:

(1) You can also contact your local Altera sales office or sales representative.

Typographic Conventions

This document uses the typographic conventions shown below.

| Visual Cue | Meaning |
|---|---|
| Bold Type with Initial Capital Letters | Command names, dialog box titles, checkbox options, and dialog box options are shown in bold, initial capital letters. Example: Save As dialog box. |
| bold type | External timing parameters, directory names, project names, disk drive names, file names, file name extensions, and software utility names are shown in bold type. Examples: f_{MAX} , \qdesigns directory, d: drive, chiptrip.gdf file. |
| <i>Italic Type with Initial Capital Letters</i> | Document titles are shown in italic type with initial capital letters. Example: <i>AN 75: High-Speed Board Design</i> . |
| <i>Italic type</i> | Internal timing parameters and variables are shown in italic type. Examples: <i>t_{PIA}</i> , <i>n + 1</i> . Variable names are enclosed in angle brackets (< >) and shown in italic type. Example: < <i>file name</i> >, < <i>project name</i> >. pdf file. |
| Initial Capital Letters | Keyboard keys and menu names are shown with initial capital letters. Examples: Delete key, the Options menu. |
| "Subheading Title" | References to sections within a document and titles of on-line help topics are shown in quotation marks. Example: "Typographic Conventions." |
| Courier type | Signal and port names are shown in lowercase Courier type. Examples: data1, tdi, input. Active-low signals are denoted by suffix n, e.g., resetn. Anything that must be typed exactly as it appears is shown in Courier type. For example: c:\qdesigns\tutorial\chiptrip.gdf. Also, sections of an actual file, such as a Report File, references to parts of files (e.g., the AHDL keyword SUBDESIGN), as well as logic function names (e.g., TRI) are shown in Courier. |
| 1., 2., 3., and a., b., c., etc. | Numbered steps are used in a list of items when the sequence of the items is important, such as the steps listed in a procedure. |
| ■ ● • | Bullets are used in a list of items when the sequence of the items is not important. |
| ✓ | The checkmark indicates a procedure that consists of one step only. |
|  | The hand points to information that requires special attention. |
|  | A caution calls attention to a condition or possible situation that can damage or destroy the product or the user's work. |
|  | A warning calls attention to a condition or possible situation that can cause injury to the user. |
| ↵ | The angled arrow indicates you should press the Enter key. |
|  | The feet direct you to more information on a particular topic. |