

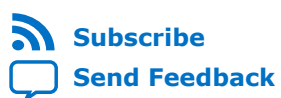

FIFO Intel® FPGA IP User Guide

Updated for Intel® Quartus® Prime Design Suite: **18.0**



[Subscribe](#)

[Send Feedback](#)

UG-MFNALT_FIFO | 2020.12.14

Latest document on the web: [PDF](#) | [HTML](#)



Contents

FIFO Intel® FPGA IP User Guide.....	3
Configuration Methods.....	3
Specifications.....	4
Verilog HDL Prototype.....	4
VHDL Component Declaration.....	4
VHDL LIBRARY-USE Declaration.....	4
FIFO Signals.....	4
FIFO Parameter Settings.....	8
FIFO Functional Timing Requirements.....	11
SCFIFO ALMOST_EMPTY Functional Timing.....	12
FIFO Output Status Flag and Latency.....	13
FIFO Metastability Protection and Related Options.....	15
FIFO Synchronous Clear and Asynchronous Clear Effect.....	17
Recovery and Removal Timing Violation Warnings when Compiling a DCFIFO.....	18
SCFIFO and DCFIFO Show-Ahead Mode.....	19
Different Input and Output Width.....	20
DCFIFO Timing Constraint Setting.....	21
Embedded Timing Constraint.....	21
User Configurable Timing Constraint.....	22
Coding Example for Manual Instantiation.....	25
Design Example.....	26
Gray-Code Counter Transfer at the Clock Domain Crossing.....	30
Guidelines for Embedded Memory ECC Feature.....	31
FIFO Intel FPGA IP User Guide Archives.....	32
Document Revision History for the FIFO Intel FPGA IP User Guide.....	33

FIFO Intel® FPGA IP User Guide

Intel® provides FIFO Intel FPGA IP core through the parameterizable single-clock FIFO (SCFIFO) and dual-clock FIFO (DCFIFO) functions. The FIFO functions are mostly applied in data buffering applications that comply with the first-in-first-out data flow in synchronous or asynchronous clock domains.

The specific names of the FIFO functions are as follows:

- SCFIFO: single-clock FIFO
- DCFIFO: dual-clock FIFO (supports same port widths for input and output data)
- DCFIFO_MIXED_WIDTHS: dual-clock FIFO (supports different port widths for input and output data)

Note: The term “DCFIFO” refers to both the DCFIFO and DCFIFO_MIXED_WIDTHS functions, unless specified.

Related Information

- [Introduction to Intel FPGA IP Cores](#)
Provides general information about all Intel FPGA IP cores, including parameterizing, generating, upgrading, and simulating IP cores.
- [Creating Version-Independent IP and Platform Designer Simulation Scripts](#)
Creates simulation scripts that do not require manual updates for software or IP version upgrades.
- [Project Management Best Practices](#)
Guidelines for efficient management and portability of your project and IP files.
- [FIFO Intel FPGA IP User Guide Archives](#) on page 32
Provides a list of user guides for previous versions of the FIFO Intel FPGA IP core.

Configuration Methods

Table 1. Configuration Methods

You can configure and build the FIFO Intel FPGA IP core with methods shown in the following table.

Method	Description
Using the FIFO parameter editor.	Intel recommends using this method to build your FIFO Intel FPGA IP core. It is an efficient way to configure and build the FIFO Intel FPGA IP core. The FIFO parameter editor provides options that you can easily use to configure the FIFO Intel FPGA IP core.

continued...



Method	Description
	You can access the FIFO Intel FPGA IP core parameter editor in Basic Functions > On Chip Memory > FIFO of the IP catalog. ⁽¹⁾
Manually instantiating the FIFO Intel FPGA IP core.	Use this method only if you are an expert user. This method requires that you know the detailed specifications of the IP core. You must ensure that the input and output ports used, and the parameter values assigned are valid for the FIFO Intel FPGA IP core you instantiate for your target device.

Related Information

[Introduction to Intel FPGA IP Cores](#)

Provides general information about the Intel Quartus® Prime Parameter Editor

Specifications

Verilog HDL Prototype

You can locate the Verilog HDL prototype in the Verilog Design File (.v) `altera_mf.v` in the <Intel Quartus® Prime installation directory>\eda\sim_lib directory.

VHDL Component Declaration

The VHDL component declaration is located in the <Intel Quartus Prime installation directory>\libraries\vhdl\altera_mf\altera_mf_components.vhd

VHDL LIBRARY-USE Declaration

The VHDL LIBRARY-USE declaration is not required if you use the VHDL Component Declaration.

```
LIBRARY altera_mf;  
  
USE altera_mf.altera_mf_components.all;
```

FIFO Signals

This section provides diagrams of the SCFIFO and DCFIFO blocks of the FIFO Intel FPGA IP core to help in visualizing their input and output ports. This section also describes each port in detail to help in understanding their usages, functionality, or any restrictions. For better illustrations, some descriptions might refer you to a specific section in this user guide.

⁽¹⁾ Do not use `dcfifo` or `scfifo` as the entity name for your FIFO Platform Designer system.



Figure 1. SCFIFO and DCFIFO Input and Output Signals

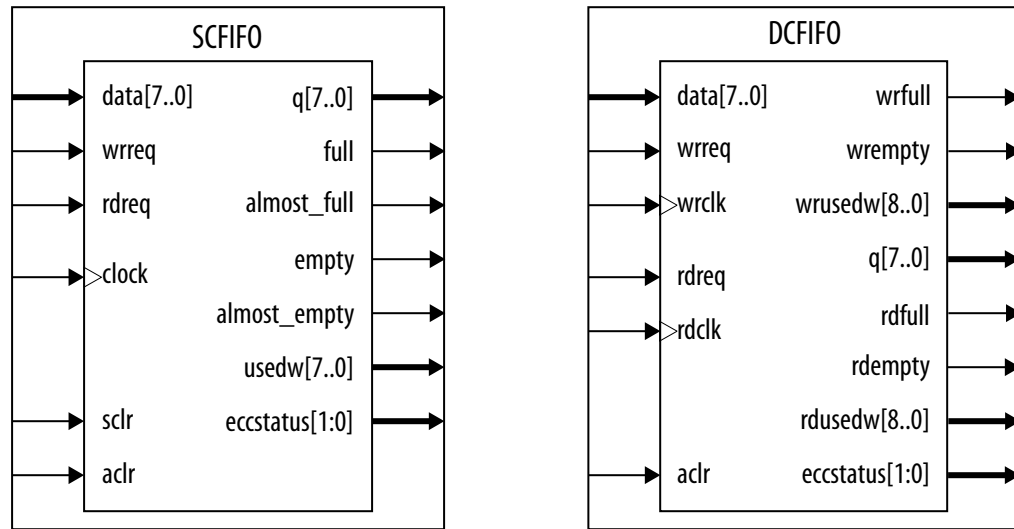

For the SCFIFO block, the read and write signals are synchronized to the same clock; for the DCFIFO block, the read and write signals are synchronized to the `rdclk` and `wrclk` clocks respectively. The prefixes `wr` and `rd` represent the signals that are synchronized by the `wrclk` and `rdclk` clocks respectively.

Table 2. Input and Output Ports Description

This table lists the signals of the FIFO Intel FPGA IP core. The term “series” refers to all the device families of a particular device. For example, “Stratix® series” refers to the Stratix IV and Stratix V, unless specified otherwise.

Port	Type	Required	Description
<code>clock</code> ⁽²⁾	Input	Yes	Positive-edge-triggered clock.
<code>wrclk</code> ⁽³⁾	Input	Yes	Positive-edge-triggered clock. Use to synchronize the following ports: <ul style="list-style-type: none"> • <code>data</code> • <code>wrreq</code> • <code>wrfull</code> • <code>wrempty</code> • <code>wrusedw</code>
<code>rdclk</code> ⁽³⁾	Input	Yes	Positive-edge-triggered clock. Use to synchronize the following ports: <ul style="list-style-type: none"> • <code>q</code> • <code>rdreq</code> • <code>rdfull</code> • <code>rdempty</code> • <code>rdusedw</code>

continued...

⁽²⁾ Only applicable for the SCFIFO function.

⁽³⁾ Applicable for both of the DCFIFO functions.



Port	Type	Required	Description
data ⁽⁴⁾	Input	Yes	Holds the data to be written in the FIFO Intel FPGA IP core when the <code>wrreq</code> signal is asserted. If you manually instantiate the FIFO Intel FPGA IP core, ensure the port width is equal to the <code>lpm_width</code> parameter.
wrreq ⁽⁴⁾	Input	Yes	Assert this signal to request for a write operation. Ensure that the following conditions are met: <ul style="list-style-type: none"> Do not assert the <code>wrreq</code> signal when the <code>full</code> (for SCFIFO) or <code>wrfull</code> (for DCFIFO) port is high. Enable the overflow protection circuitry or set the <code>overflow_checking</code> parameter to ON so that the FIFO Intel FPGA IP core can automatically disable the <code>wrreq</code> signal when it is full. The <code>wrreq</code> signal must meet the functional timing requirement based on the <code>full</code> or <code>wrfull</code> signal. Do not assert the <code>wrreq</code> signal during the deassertion of the <code>aclr</code> signal. Violating this requirement creates a race condition between the falling edge of the <code>aclr</code> signal and the rising edge of the write clock if the <code>wrreq</code> port is set to high. For both the DCFIFO functions that target Stratix and Cyclone® series, you have the option to automatically add a circuit to synchronize the <code>aclr</code> signal with the <code>wrclk</code> clock, or set the <code>write_aclr_synch</code> parameter to ON. Use this option to ensure that the restriction is obeyed.
rdreq ⁽⁴⁾	Input	Yes	Assert this signal to request for a read operation. The <code>rdreq</code> signal acts differently in normal mode and show-ahead mode. Ensure that the following conditions are met: <ul style="list-style-type: none"> Do not assert the <code>rdreq</code> signal when the <code>empty</code> (for SCFIFO) or <code>rdempty</code> (for DCFIFO) port is high. Enable the underflow protection circuitry or set the <code>underflow_checking</code> parameter to ON so that the FIFO Intel FPGA IP core can automatically disable the <code>rdreq</code> signal when it is empty. The <code>rdreq</code> signal must meet the functional timing requirement based on the <code>empty</code> or <code>rdempty</code> signal.
sclr ⁽²⁾ aclr ⁽⁴⁾	Input	No	Assert this signal to clear all the output status ports, but the effect on the <code>q</code> output may vary for different FIFO configurations. There are no minimum number of clock cycles for <code>aclr</code> signals that must remain active.
q ⁽⁴⁾	Output	Yes	Shows the data read from the read request operation. For the SCFIFO function and DCFIFO function, the width of the <code>q</code> port must be equal to the width of the <code>data</code> port. If you manually instantiate the FIFO functions, ensure that the port width is equal to the <code>lpm_width</code> parameter. For the DCFIFO_MIXED_WIDTHS function, the width of the <code>q</code> port can be different from the width of the <code>data</code> port. If you manually instantiate the FIFO function, ensure that the width of the <code>q</code> port is equal to the <code>lpm_width_r</code> parameter. The FIFO function supports a wide write port with a narrow read port, and vice versa. However, the width ratio is restricted by the type of RAM block, and in general, are in the power of 2.
full ⁽²⁾ wrfull ⁽³⁾ rdfull ⁽³⁾	Output	No	When asserted, the FIFO Intel FPGA IP core is considered full. Do not perform write request operation when the FIFO Intel FPGA IP core is full. In general, the <code>rdfull</code> signal is a delayed version of the <code>wrfull</code> signal. However, for Stratix III devices and later, the <code>rdfull</code> signal functions as a combinational output instead of a derived

continued...

⁽⁴⁾ Applicable for the SCFIFO, DCFIFO, and DCFIFO_MIXED_WIDTH functions.



Port	Type	Required	Description
			version of the <code>wrfull</code> signal. Therefore, you must always refer to the <code>wrfull</code> port to ensure whether or not a valid write request operation can be performed, regardless of the target device.
<code>empty</code> ⁽²⁾ <code>wrempty</code> ⁽³⁾ <code>rdempty</code> ⁽³⁾	Output	No	When asserted, the FIFO Intel FPGA IP core is considered empty. Do not perform read request operation when the FIFO Intel FPGA IP core is empty. In general, the <code>wrempty</code> signal is a delayed version of the <code>rdempty</code> signal. However, for Stratix III devices and later, the <code>wrempty</code> signal functions as a combinational output instead of a derived version of the <code>rdempty</code> signal. Therefore, you must always refer to the <code>rdempty</code> port to ensure whether or not a valid read request operation can be performed, regardless of the target device.
<code>almost_full</code> ⁽²⁾	Output	No	Asserted when the <code>usedw</code> signal is greater than or equal to the <code>almost_full_value</code> parameter. It is used as an early indication of the <code>full</code> signal.
<code>almost_empty</code> ⁽²⁾	Output	No	Asserted when the <code>usedw</code> signal is less than the <code>almost_empty_value</code> parameter. It is used as an early indication of the <code>empty</code> signal. ⁽⁵⁾
<code>usedw</code> ⁽²⁾ <code>wrusedw</code> ⁽³⁾ <code>rdusedw</code> ⁽³⁾	Output	No	Show the number of words stored in the FIFO. Ensure that the port width is equal to the <code>lpm_widthu</code> parameter if you manually instantiate the SCFIFO function or the DCFIFO function. For the DCFIFO_MIXED_WIDTH function, the width of the <code>wrusedw</code> and <code>rdusedw</code> ports must be equal to the <code>LPM_WIDTHU</code> and <code>lpm_widthu_r</code> parameters respectively. For Stratix, Stratix GX, and Cyclone devices, the FIFO Intel FPGA IP core shows full even before the number of words stored reaches its maximum value. Therefore, you must always refer to the <code>full</code> or <code>wrfull</code> port for valid write request operation, and the <code>empty</code> or <code>rdempty</code> port for valid read request operation regardless of the target device. <i>Note:</i> Stored data may not be available for reading. Refer to FIFO Output Status Flag and Latency on page 13 for " <code>wrreq</code> to <code>empty</code> " and " <code>rdreq</code> to <code>empty</code> " latency to ensure that the data is ready before reading the FIFO.
<code>eccstatus</code> ⁽⁶⁾	Output	No	A 2-bit wide error correction status port. Indicate whether the data that is read from the memory has an error in single-bit with correction, fatal error with no correction, or no error bit occurs. <ul style="list-style-type: none"> • 00: No error • 01: Illegal • 10: A correctable error occurred and the error has been corrected at the outputs; however, the memory array has not been updated. • 11: An uncorrectable error occurred and uncorrectable data appears at the output. This port is only available for Intel Arria® 10 devices using M20K memory block type.

⁽⁵⁾ Under certain condition, the SCFIFO asserts the `empty` signal without ever asserting the `almost_empty` signal. Refer to [SCFIFO ALMOST_EMPTY Functional Timing](#) on page 12 for more details.

⁽⁶⁾ Not applicable for the DCFIFO_MIXED_WIDTHS function.



The DCFIFO function `rdempty` output may momentarily glitch when the `aclr` input is asserted. To prevent an external register from capturing this glitch incorrectly, ensure that one of the following is true:

- The external register must use the same reset which is connected to the `aclr` input of the DCFIFO function, or
- The reset connected to the `aclr` input of the DCFIFO function must be asserted synchronous to the clock which drives the external register.

The output latency information of the FIFO Intel FPGA IP core is important, especially for the `q` output port, because there is no output flag to indicate when the output is valid to be sampled.

FIFO Parameter Settings

Table 3. FIFO Parameters

Parameter	Type	Required	Description
<code>lpm_width</code>	Integer	Yes	Specifies the width of the <code>data</code> and <code>q</code> ports for the SCFIFO function and DCFIFO function. For the DCFIFO_MIXED_WIDTHS function, this parameter specifies only the width of the <code>data</code> port.
<code>lpm_width_r</code> ⁽⁷⁾	Integer	Yes	Specifies the width of the <code>q</code> port for the DCFIFO_MIXED_WIDTHS function.
<code>lpm_widthu</code>	Integer	Yes	Specifies the width of the <code>usedw</code> port for the SCFIFO function, or the width of the <code>rdusedw</code> and <code>wrusedw</code> ports for the DCFIFO function. For the DCFIFO_MIXED_WIDTHS function, it only represents the width of the <code>wrusedw</code> port.
<code>lpm_widthu_r</code> ⁽⁷⁾	Integer	Yes	Specifies the width of the <code>rdusedw</code> port for the DCFIFO_MIXED_WIDTHS function.
<code>lpm_numwords</code>	Integer	Yes	Specifies the depths of the FIFO you require. The value must be at least 4 . The value assigned must comply to the following equation: $2^{\text{LPM_WIDTHU}}$
<code>lpm_showahead</code>	String	Yes	Specifies whether the FIFO is in normal mode (<code>OFF</code>) or show-ahead mode (<code>ON</code>). For more details, refer to SCFIFO and DCFIFO Look-Ahead Mode section. If you set the parameter to ON , you may reduce performance.
<code>lpm_type</code>	String	No	Identifies the library of parameterized modules (LPM) entity name. The values are SCFIFO and DCFIFO .

continued...

⁽⁷⁾ Only applicable for the DCFIFO_MIXED_WIDTHS function.

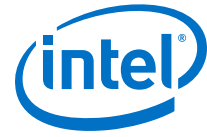

Parameter	Type	Required	Description
lpm_hint	String	No	<p>This is a legacy parameter that is used to set the following:</p> <ol style="list-style-type: none"> Maximum depth. You can set the maximum depth desired with "MAXIMUM_DEPTH=<depth>". Allow the Intel Quartus Prime software to automatically choose the maximum depth of the RAM used in SCFIFO by ignoring this parameter. RAM block type. You can select the RAM block type with "RAM_BLOCK_TYPE=<M20K MLAB AUTO>". The default value is AUTO. Disable Embedded Timing Constraint. This is a compulsory parameter to be set for DCFIFO on Intel Arria 10 device family onwards, which disables the legacy <code>set_false_path</code> that resides in FIFO Intel FPGA IP. Add "DISABLE_EMBEDDED_TIMING_CONSTRAINT=TRUE" to <code>lpm_hint</code> for proper timing analysis on the synchronizer path within DCFIFO IP. <p>Options should be concatenated with a comma in between and enclosed with double quotations. For example: <code>lpm_hint = "MAXIMUM_DEPTH=512, RAM_BLOCK_TYPE=M20K"</code></p>
overflow_checking	String	No	<p>Specifies whether or not to enable the protection circuitry for overflow checking that disables the <code>wrreq</code> port when the FIFO Intel FPGA IP core is full. The values are ON or OFF. If omitted, the default is ON.</p>
underflow_checking	String	No	<p>Specifies whether or not to enable the protection circuitry for underflow checking that disables the <code>rdreq</code> port when the FIFO Intel FPGA IP core is empty. The values are ON or OFF. If omitted, the default is ON.</p> <p>Note that reading from an empty SCFIFO gives unpredictable results.</p>
enable_ecc ⁽⁸⁾	String	No	<p>Specifies whether to enable the error checking and correcting (ECC) feature that corrects single bit errors, double adjacent bit errors, and detects triple adjacent bit errors at the output of the memory. This option is only available for Intel Arria 10 devices using M20K memory block type.</p> <p>The ECC is disabled by default.</p>
delay_wrusedw ⁽⁹⁾	String	No	<p>Specify the number of register stages that you want to internally add to the <code>rdusedw</code> or <code>wrusedw</code> port using the respective parameter.</p> <p>The default value of 1 adds a single register stage to the output to improve its performance. Increasing the value of the parameter does not increase the maximum system speed. It only adds additional latency to the respective output port.</p>
add_usedw_msb_bit ⁽⁹⁾	String	No	<p>Increases the width of the <code>rdusedw</code> and <code>wrusedw</code> ports by one bit. By increasing the width, it prevents the FIFO Intel FPGA IP core from rolling over to zero when it is full. The values are ON or OFF. If omitted, the default value is OFF.</p>

continued...

⁽⁸⁾ Not applicable for the DCFIFO_MIXED_WIDTHS function.

⁽⁹⁾ Only applicable for the DCFIFO function.



Parameter	Type	Required	Description
rdsync_delaypipe ⁽⁹⁾ wrsync_delaypipe ⁽⁹⁾	Integer	No	Specify the number of synchronization stages in the cross clock domain. The value of the <code>rdsync_delaypipe</code> parameter relates the synchronization stages from the write control logic to the read control logic; the <code>wrsync_delaypipe</code> parameter relates the synchronization stages from the read control logic to the write control logic. Use these parameters to set the number of synchronization stages if the clocks are not synchronized, and set the <code>clocks_are_synchronized</code> parameter to FALSE . The actual synchronization stage implemented relates variously to the parameter value assigned, depends on the target device. The values of these parameters are internally reduced by two. Thus, the default value of 3 for these parameters corresponds to a single synchronization stage; a value of 4 results in two synchronization stages, and so on. Choose at least 4 (two synchronization stages) for metastability protection.
use_eab	String	No	Specifies whether or not the FIFO Intel FPGA IP core is constructed using the RAM blocks. The values are ON or OFF . Setting this parameter value to OFF yields the FIFO Intel FPGA IP core implemented in ALMs regardless of the type of the TriMatrix memory block type assigned to the <code>ram_block_type</code> parameter. This parameter is enabled by default. FIFO will be implemented using RAM blocks specified in <code>ram_block_type</code> .
write_aclr_synch ⁽⁹⁾	String	No	Specifies whether or not to add a circuit that causes the <code>aclr</code> port to be internally synchronized by the <code>wrcclk</code> clock. Adding the circuit prevents the race condition between the <code>wrreq</code> and <code>aclr</code> ports that could corrupt the FIFO Intel FPGA IP core. The values are ON or OFF . If omitted, the default value is OFF . This parameter is only applicable for Stratix and Cyclone series.
read_aclr_synch ⁽⁹⁾	String	No	Specifies whether or not to add a circuit that causes the <code>aclr</code> port to be internally synchronized by the <code>rdclk</code> clock. Adding the circuit prevents the race condition between the <code>rdreq</code> and <code>aclr</code> ports that could corrupt the FIFO Intel FPGA IP core. The values are ON or OFF . If omitted, the default value is OFF .
clocks_are_synchronized ⁽⁹⁾	String	No	Specifies whether or not the write and read clocks are synchronized which in turn determines the number of internal synchronization stages added for stable operation of the FIFO. The values are TRUE and FALSE . If omitted, the default value is FALSE . You must only set the parameter to TRUE if the write clock and the read clock are always synchronized and they are multiples of each other. Otherwise, set this to FALSE to avoid metastability problems. If the clocks are not synchronized, set the parameter to FALSE , and use the <code>rdsync_delaypipe</code> and <code>wrsync_delaypipe</code> parameters to determine the number of synchronization stages required.
ram_block_type	String	No	Specifies the target device's Trimatrix Memory Block to be used. To get the proper implementation based on the RAM configuration that you set, allow the Intel Quartus Prime

continued...



Parameter	Type	Required	Description
			software to automatically choose the memory type by ignoring this parameter and set the <code>use_eab</code> parameter to ON . This gives the compiler the flexibility to place the memory function in any available memory resource based on the FIFO depth required. Types of RAM block type available; Auto (default), MLAB, M20K and M144K.
<code>add_ram_output_register</code>	String	No	Specifies whether to register the <code>q</code> output. The values are ON and OFF . If omitted, the default value is OFF . You can set the parameter to ON or OFF for the SCFIFO or the DCFIFO, that do not target Stratix II, Cyclone II, and new devices. This parameter does not apply to these devices because the <code>q</code> output must be registered in normal mode and unregistered in show-ahead mode for the DCFIFO.
<code>almost_full_value</code> ⁽¹⁰⁾	Integer	No	Sets the threshold value for the <code>almost_full</code> port. When the number of words stored in the FIFO Intel FPGA IP core is greater than or equal to this value, the <code>almost_full</code> port is asserted.
<code>almost_empty_value</code> ⁽¹⁰⁾	Integer	No	Sets the threshold value for the <code>almost_empty</code> port. When the number of words stored in the FIFO Intel FPGA IP core is less than this value, the <code>almost_empty</code> port is asserted.
<code>allow_wrcycle_when_full</code> ⁽¹⁰⁾	String	No	Allows you to combine read and write cycles to an already full SCFIFO, so that it remains full. The values are ON and OFF . If omitted, the default is OFF . Use only this parameter when the <code>OVERFLOW_CHECKING</code> parameter is set to ON .
<code>intended_device_family</code>	String	No	Specifies the intended device that matches the device set in your Intel Quartus Prime project. Use only this parameter for functional simulation.

FIFO Functional Timing Requirements

The `wrreq` signal is ignored (when FIFO is full) if you enable the overflow protection circuitry in the FIFO Intel FPGA IP parameter editor, or set the `OVERFLOW_CHECKING` parameter to **ON**. The `rdreq` signal is ignored (when FIFO is empty) if you enable the underflow protection circuitry in the FIFO Intel FPGA IP core interface, or set the `UNDERFLOW_CHECKING` parameter to **ON**.

If the protection circuitry is not enabled, you must meet the following functional timing requirements:

Table 4. Functional Timing Requirements

DCFIFO	SCFIFO
Deassert the <code>wrreq</code> signal in the same clock cycle when the <code>wrfull</code> signal is asserted.	Deassert the <code>wrreq</code> signal in the same clock cycle when the <code>full</code> signal is asserted.
Deassert the <code>rdreq</code> signal in the same clock cycle when the <code>rdempty</code> signal is asserted. You must observe these requirements regardless of expected behavior based on <code>wrclk</code> and <code>rdclk</code> frequencies.	Deassert the <code>rdreq</code> signal in the same clock cycle when the <code>empty</code> signal is asserted.

⁽¹⁰⁾ Only applicable for the SCFIFO function.

Figure 2. Functional Timing for the `wrreq` Signal and the `wrfull` Signal

This figure shows the behavior for the `wrreq` and the `wrfull` signals.

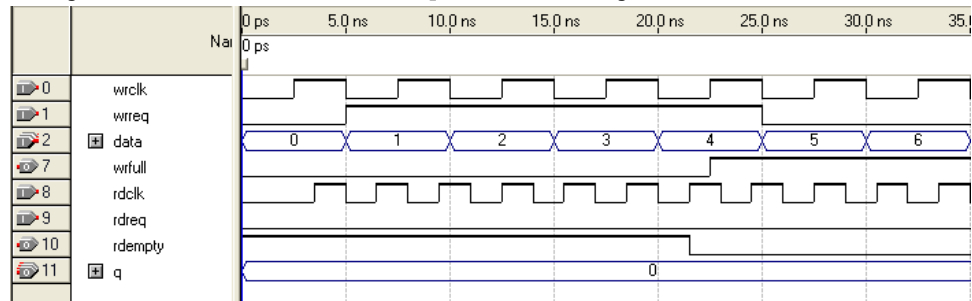
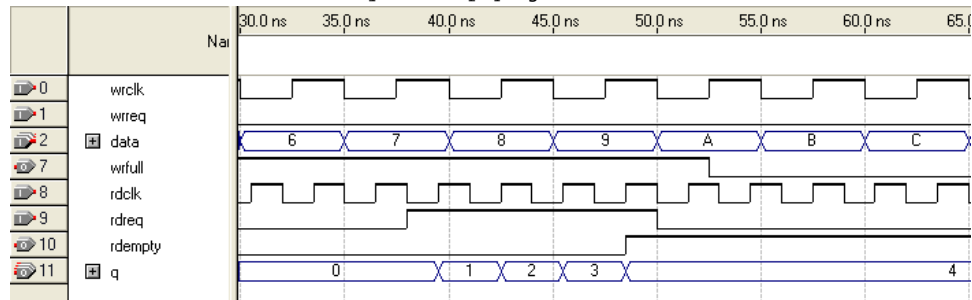

Figure 3. Functional Timing for the `rdreq` Signal and the `rdempty` Signal

This shows the behavior for the `rdreq` the `rdempty` signals.



The required functional timing for the DCFIFO as described previously is also applied to the SCFIFO. The difference between the two modes is that for the SCFIFO, the `wrreq` signal must meet the functional timing requirement based on the `full` signal and the `rdreq` signal must meet the functional timing requirement based on the `empty` signal.

SCFIFO ALMOST_EMPTY Functional Timing

In SCFIFO, the `almost_empty` is asserted only when the `usedw` is less than the `almost_empty_value` that you set. The `almost_empty` signal does not consider the data readiness at the output. When the `almost_empty_value` is set too low, it is possible to observe that SCFIFO asserts the `empty` signal without asserting the `almost_empty` signal.

Figure 4. Example of `empty` Signal Assertion without Asserting `almost_empty` Signal

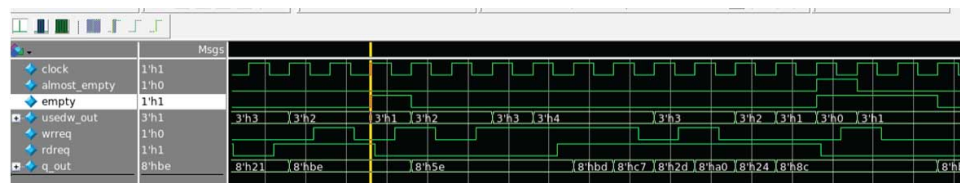

In this example, the `almost_empty_value` is 1 which means the `almost_empty` will assert when `usedw` is 0. There are three words in the FIFO before the read request is received. After the first read, the `wrreq` asserts and the `rdreq` signal remains high.



The `usedw` remains at 2. In the next cycle, the `wrreq` de-asserts but there is another `rdreq` going on. The `usedw` decrease to 1 and the `almost_empty` signal remains low. However, the write data has not been written into the FIFO due to the write latency. The `empty` signal asserts to indicate the FIFO is empty.

FIFO Output Status Flag and Latency

The main concern in most FIFO design is the output latency of the read and write status signals.

Table 5. Output Latency of the Status Flags for SCFIFO

This table shows the output latency of the write signal (`wrreq`) and read signal (`rdreq`) for the SCFIFO according to the different output modes and optimization options.

Output Mode	Optimization Option ⁽¹¹⁾	Output Latency (in number of clock cycles) ⁽¹²⁾
Normal ⁽¹³⁾	Speed	<code>wrreq / rdreq</code> to full: 1
		<code>wrreq</code> to empty: 2
		<code>rdreq</code> to empty: 1
		<code>wrreq / rdreq</code> to <code>usedw[]</code> : 1
		<code>rdreq</code> to <code>q[]</code> : 1
	Area	<code>wrreq / rdreq</code> to full: 1
		<code>wrreq / rdreq</code> to empty : 1
		<code>wrreq / rdreq</code> to <code>usedw[]</code> : 1
<code>rdreq</code> to <code>q[]</code> : 1		
Show-ahead ⁽¹³⁾	Speed	<code>wrreq / rdreq</code> to full: 1
		<code>wrreq</code> to empty: 3
		<code>rdreq</code> to empty: 1
		<code>wrreq / rdreq</code> to <code>usedw[]</code> : 1
		<code>wrreq</code> to <code>q[]</code> : 3
		<code>rdreq</code> to <code>q[]</code> : 1
	Area	<code>wrreq / rdreq</code> to full: 1
		<code>wrreq</code> to empty: 2
<code>rdreq</code> to empty: 1		

continued...

- (11) Speed optimization is equivalent to setting the `ADD_RAM_OUTPUT_REGISTER` parameter to `ON`. Setting the parameter to `OFF` is equivalent to area optimization.
- (12) The information of the output latency is applicable for Stratix and Cyclone series only. It may not be applicable for legacy devices such as the APEX® and FLEX® series.
- (13) Normal output mode is equivalent to setting the `LPM_SHOWAHEAD` parameter to `OFF`. For Show-ahead mode, the parameter is set to `ON`.

Output Mode	Optimization Option ⁽¹¹⁾	Output Latency (in number of clock cycles) ⁽¹²⁾
		wrreq / rdreq to usedw[]: 1
		wrreq to q[]: 2
		rdreq to q[]: 1

Table 6. ALM Implemented RAM Mode for SCFIFO and DCFIFO

Output Mode	Optimization Option ⁽¹⁴⁾	Output Latency (in number of clock cycles) ⁽¹⁵⁾
Normal ⁽¹⁶⁾	Speed	wrreq / rdreq to full: 1
		wrreq to empty: 1
		rdreq to empty: 1
		wrreq / rdreq to usedw[]: 1
		rdreq to q[]: 1
	Area	wrreq / rdreq to full: 1
		wrreq / rdreq to empty : 1
		wrreq / rdreq to usedw[] : 1
Show-ahead ⁽¹⁶⁾	Speed	wrreq / rdreq to full: 1
		wrreq to empty: 1
		rdreq to empty: 1
		wrreq / rdreq to usedw[]: 1
		wrreq to q[]: 1
		rdreq to q[]: 1
	Area	wrreq / rdreq to full: 1
		wrreq to empty: 1
		rdreq to empty: 1

continued...

- ⁽¹¹⁾ Speed optimization is equivalent to setting the ADD_RAM_OUTPUT_REGISTER parameter to ON. Setting the parameter to OFF is equivalent to area optimization.
- ⁽¹²⁾ The information of the output latency is applicable for Stratix and Cyclone series only. It may not be applicable for legacy devices such as the APEX® and FLEX® series.
- ⁽¹⁴⁾ Speed optimization is equivalent to setting the ADD_RAM_OUTPUT_REGISTER parameter to ON. Setting the parameter to OFF is equivalent to area optimization.
- ⁽¹⁵⁾ The information of the output latency is applicable for Stratix and Cyclone series only. It may not be applicable for legacy devices such as the APEX® and FLEX® series.
- ⁽¹⁶⁾ Normal output mode is equivalent to setting the LPM_SHOWAHEAD parameter to OFF. For Show-ahead mode, the parameter is set to ON.



Output Mode	Optimization Option ⁽¹⁴⁾	Output Latency (in number of clock cycles) ⁽¹⁵⁾
		wrreq / rdreq to usedw[]: 1
		wrreq to q[]: 1
		rdreq to q[]: 1

Table 7. Output Latency of the Status Flag for the DCFIFO

This table shows the output latency of the write signal (wrreq) and read signal (rdreq) for the DCFIFO.

Output Latency (in number of clock cycles) ⁽¹⁷⁾
wrreq to wrfull: 1 wrclk
wrreq to rdfull: 2 wrclk cycles + following n rdclk ⁽¹⁸⁾
wrreq to wrempty: 1 wrclk
wrreq to rdempty: 2 wrclk ⁽¹⁹⁾ + following n rdclk ⁽¹⁹⁾
wrreq to wrusedw[]: 2 wrclk
wrreq to rdusedw[]: 2 wrclk + following n + 1 rdclk ⁽¹⁹⁾
wrreq to q[]: 1 wrclk + following 1 rdclk ⁽¹⁹⁾
rdreq to rdempty: 1 rdclk
rdreq to wrempty: 1 rdclk + following n wrclk ⁽¹⁹⁾
rdreq to rfull: 1 rdclk
rdreq to wrfull: 1 rdclk + following n wrclk ⁽¹⁹⁾
rdreq to rdusedw[]: 2 rdclk
rdreq to wrusedw[]: 1 rdclk + following n + 1 wrclk ⁽¹⁹⁾
rdreq to q[]: 1 rdclk

FIFO Metastability Protection and Related Options

The FIFO Intel FPGA IP parameter editor provides the total latency, clock synchronization, metastability protection, area, and f_{MAX} options as a group setting for the DCFIFO.

- ⁽¹⁴⁾ Speed optimization is equivalent to setting the ADD_RAM_OUTPUT_REGISTER parameter to ON. Setting the parameter to OFF is equivalent to area optimization.
- ⁽¹⁵⁾ The information of the output latency is applicable for Stratix and Cyclone series only. It may not be applicable for legacy devices such as the APEX® and FLEX® series.
- ⁽¹⁷⁾ The output latency information is only applicable for Arria® GX, Stratix, and Cyclone series.
- ⁽¹⁸⁾ The number of n cycles for rdclk and wrclk is equivalent to the number of synchronization stages and are related to the WRSYNC_DELAYPIPE and RDSYNC_DELAYPIPE parameters. For more information about how the actual synchronization stage (n) is related to the parameters set for different target device, refer to Table 9 on page 16.
- ⁽¹⁹⁾ This is applied only to Show-ahead output modes. Show-ahead output mode is equivalent to setting the LPM_SHOWAHEAD parameter to ON.

Table 8. DCFIFO Group Setting for Latency and Related Options

This table shows the available group setting.

Group Setting	Comment
Lowest latency but requires synchronized clocks	This option uses one synchronization stage with no metastability protection. It uses the smallest size and provides good f_{MAX} . Select this option if the read and write clocks are related clocks.
Minimal setting for unsynchronized clocks	This option uses two synchronization stages with good metastability protection. It uses the medium size and provides good f_{MAX} .
Best metastability protection, best f_{max} and unsynchronized clocks	This option uses three or more synchronization stages with the best metastability protection. It uses the largest size but gives the best f_{MAX} .

The group setting for latency and related options is available through the FIFO Intel FPGA IP parameter editor. The setting mainly determines the number of synchronization stages, depending on the group setting you select. You can also set the number of synchronization stages you desire through the `WRSYNC_DELAYPIPE` and `RDSYNC_DELAYPIPE` parameters, but you must understand how the actual number of synchronization stages relates to the parameter values set in different target devices.

The **number of synchronization stages** set is related to the value of the `WRSYNC_DELAYPIPE` and `RDSYNC_DELAYPIPE` pipeline parameters. For some cases, these pipeline parameters are internally scaled down by two to reflect the actual synchronization stage.

Table 9. Relationship between the Actual Synchronization Stage and the Pipeline Parameters for Different Target Devices

This table shows the relationship between the actual synchronization stage and the pipeline parameters.

Stratix II, Cyclone II, and later	Other Devices
Actual synchronization stage = value of pipeline parameter - 2 ⁽²⁰⁾	Actual synchronization stage = value of pipeline parameter

The Timing Analyzer includes the capability to estimate the robustness of asynchronous transfers in your design, and to generate a report that details the mean time between failures (MTBF) for all detected synchronization register chains. This report includes the MTBF analysis on the synchronization pipeline you applied between the asynchronous clock domains in your DCFIFO. You can then decide the number of synchronization stages to use in order to meet the range of the MTBF specification you require.

Related Information

- [Timing Closure and Optimization](#)
Provides information about enabling metastability analysis and reporting.

⁽²⁰⁾ The values assigned to `WRSYNC_DELAYPIPE` and `RDSYNC_DELAYPIPE` parameters are internally reduced by 2 to represent the actual synchronization stage implemented. Thus, the default value 3 for these parameters corresponds to a single synchronization pipe stage; a value of 4 results in 2 synchronization stages, and so on. For these devices, choose 4 (2 synchronization stages) for metastability protection.



- [Area Optimization](#)
 Provides information about enabling metastability analysis and reporting.
- [The TimeQuest Timing Analyzer](#)
 Provides information about enabling metastability analysis and reporting.

FIFO Synchronous Clear and Asynchronous Clear Effect

The FIFO Intel FPGA IP core supports the synchronous clear (`sclr`) and asynchronous clear (`aclr`) signals, depending on the FIFO modes. The effects of these signals are varied for different FIFO configurations. The SCFIFO supports both synchronous and asynchronous clear signals while the DCFIFO support asynchronous clear signal and asynchronous clear signal that synchronized with the write and read clocks.

Table 10. Synchronous Clear and Asynchronous Clear in the SCFIFO

Mode	Synchronous Clear (<code>sclr</code>) ⁽²¹⁾	Asynchronous Clear (<code>aclr</code>)
Effects on status ports	Deasserts the <code>full</code> and <code>almost_full</code> signals.	
	Asserts the <code>empty</code> and <code>almost_empty</code> signals.	
	Resets the <code>usedw</code> flag.	
Commencement of effects upon assertion	At the rising edge of the clock.	Immediate (except for the <code>q</code> output)
Effects on the <code>q</code> output for normal output modes	The read pointer is reset and points to the first data location. If the <code>q</code> output is not registered, the output shows the first data word of the SCFIFO; otherwise, the <code>q</code> output remains at its previous value.	The <code>q</code> output remains at its previous value.
Effects on the <code>q</code> output for show-ahead output modes	The read pointer is reset and points to the first data location. If the <code>q</code> output is not registered, the output remains at its previous value for only one clock cycle and shows the first data word of the SCFIFO at the next rising clock edge. ⁽²²⁾ Otherwise, the <code>q</code> output remains at its previous value.	If the <code>q</code> output is not registered, the output shows the first data word of the SCFIFO starting at the first rising clock edge. Otherwise, the <code>q</code> output remains its previous value.

⁽²¹⁾ The read and write pointers reset to zero upon assertion of either the `sclr` or `aclr` signal.

⁽²²⁾ The first data word shown after the reset is not a valid Show-ahead data. It reflects the data where the read pointer is pointing to because the `q` output is not registered. To obtain a valid Show-ahead data, perform a valid write after the reset.

Table 11. Asynchronous Clear in DCFIFO

Mode	Asynchronous Clear (aclr)	aclr (synchronize with write clock) ⁽²³⁾ ⁽²⁴⁾	aclr (synchronize with read clock) ⁽²⁵⁾
Effects on status ports	Deasserts the wrfull signal.	The wrfull signal is asserted while the write domain is clearing which nominally takes three cycles of the write clock after the asynchronous release of the aclr input.	The rdempty signal is asserted while the read domain is clearing which nominally takes three cycles of the read clock after the asynchronous release of the aclr input.
	Deasserts the rdfull signal.		
	Asserts the wrempty and rdempty signals.		
	Resets the wrusedw and rdusedw flags.		
Commencement of effects upon assertion	Immediate.		
Effects on the q output for normal output modes ⁽²⁶⁾	The output remains unchanged if it is not registered. If the port is registered, it is cleared.		
Effects on the q output for show-ahead output modes	The output shows 'X' if it is not registered. If the port is registered, it is cleared.		

Recovery and Removal Timing Violation Warnings when Compiling a DCFIFO

During compilation of a design that contains a DCFIFO, the Intel Quartus Prime software may issue recovery and removal timing violation warnings.

You may safely ignore warnings that represent transfers from aclr to the read side clock domain. To ensure that the design meets timing, enable the ACLR synchronizer for both read and write domains.

⁽²³⁾ The wrreq signal must be low when the DCFIFO comes out of reset (the instant when the aclr signal is deasserted) at the rising edge of the write clock to avoid a race condition between write and reset. If this condition cannot be guaranteed in your design, the aclr signal needs to be synchronized with the write clock. This can be done by setting the **Add circuit to synchronize 'aclr' input with 'wrclk'** option from the FIFO parameter editor, or setting the WRITE_ACLR_SYNCH parameter to ON.

⁽²⁴⁾ Even though the aclr signal is synchronized with the write clock, asserting the aclr signal still affects all the status flags asynchronously.

⁽²⁵⁾ Even though the aclr signal is synchronized with the read clock, asserting the aclr signal affects all the status flags asynchronously.

⁽²⁶⁾ For Stratix and Cyclone series, the DCFIFO only supports registered q output in Normal mode, and unregistered q output in Show-ahead mode. For other devices, you have an option to register or unregister the q output (regardless of the Normal mode or Show-ahead mode) in the FIFO parameter editor or set through the ADD_RAM_OUTPUT_REGISTER parameter.



To enable the ACLR synchronizer for both read and write domains, on the **DCFIFO 2** tab of the FIFO Intel FPGA IP core, turn on **Asynchronous clear**, **Add circuit to synchronize 'aclr' input with 'wrclk'**, and **Add circuit to synchronize 'aclr' input with 'rdclk'**.

Note: For correct timing analysis, Intel recommends enabling the **Removal and Recovery Analysis** option in the Timing Analyzer tool when you use the `aclr` signal. The analysis is turned on by default in the Timing Analyzer tool.

When the **Add circuit to synchronize 'aclr' input with 'wrclk'** and **Add circuit to synchronize 'aclr' input with 'rdclk'** options are enabled, you can apply the following false path assignment on the reset path:

- `set_false_path -to *dcfifo:dcfifo_component|dcfifo_*:auto_generated|dffpipe_*:wraclr|dfffe*a[0]`
- `set_false_path -to *dcfifo:dcfifo_component|dcfifo_*:auto_generated|dffpipe_*:rdaclr|dfffe*a[0]`

SCFIFO and DCFIFO Show-Ahead Mode

You can set the read request/`rdreq` signal read access behavior by selecting normal or show-ahead mode.

For normal mode, the FIFO Intel FPGA IP core treats the `rdreq` port as a normal read request that only performs read operation when the port is asserted.

For show-ahead mode, the FIFO Intel FPGA IP core treats the `rdreq` port as a read-acknowledge that automatically outputs the first word of valid data in the FIFO Intel FPGA IP core (when the `empty` is low) without asserting the `rdreq` signal. Asserting the `rdreq` signal causes the FIFO Intel FPGA IP core to output the next data word, if available.

Figure 5. Normal Mode Waveform

Data appears after the `rdreq` asserted.

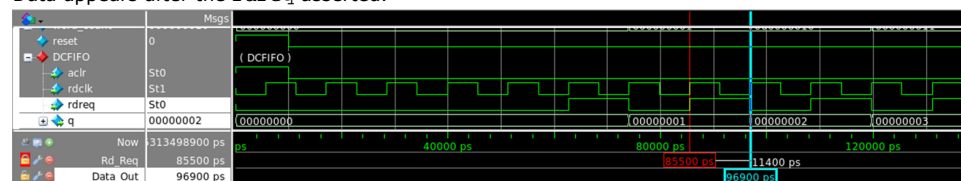
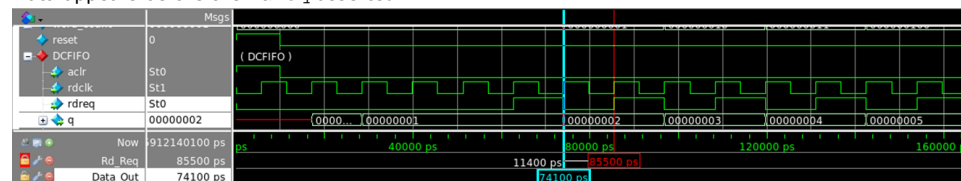

Figure 6. Show-Ahead Mode Waveform

Data appears before the `rdreq` asserted.



Different Input and Output Width

The DCFIFO_MIXED_WIDTHS function supports different write input data and read output data widths if the width ratio is valid. The FIFO parameter editor prompts an error message if the combinations of the input and the output data widths produce an invalid ratio. The supported width ratio is a power of 2 and depends on the RAM.

The IP core supports a wide write port with a narrow read port, and vice versa. The current supported mixed width ratios for Intel Arria 10 and Intel Cyclone 10 GX devices are listed in the following table:

Table 12. Device Family Support for Width Ratios

Device Family	Valid Width Ratio
Intel Arria 10	1, 2, 4, 8, 16, and 32
Intel Cyclone 10 GX	1, 2, 4, 8, 16, and 32

Figure 7. Writing 16-bit Words and Reading 8-bit Words

This figure shows an example of a wide write port (16-bit input) and a narrow read port (8-bit output).

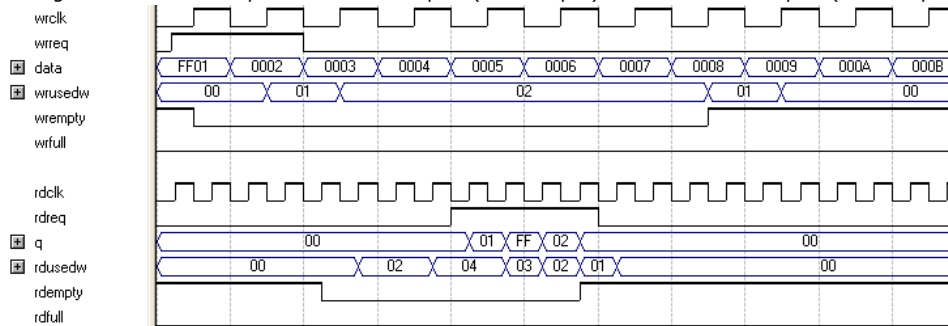

In this example, the read port is operating at twice the frequency of the write port. Writing two 16-bit words to the FIFO buffer increases the `wrusedw` flag to two and the `rusedw` flag to four. Four 8-bit read operations empty the FIFO buffer. The read begins with the least-significant 8 bits from the 16-bit word written followed by the most-significant 8 bits.

Figure 8. Writing 8-Bit Words and Reading 16-Bit Words

This figure shows an example of a narrow write port (8-bit input) with a wide read port (16-bit output).

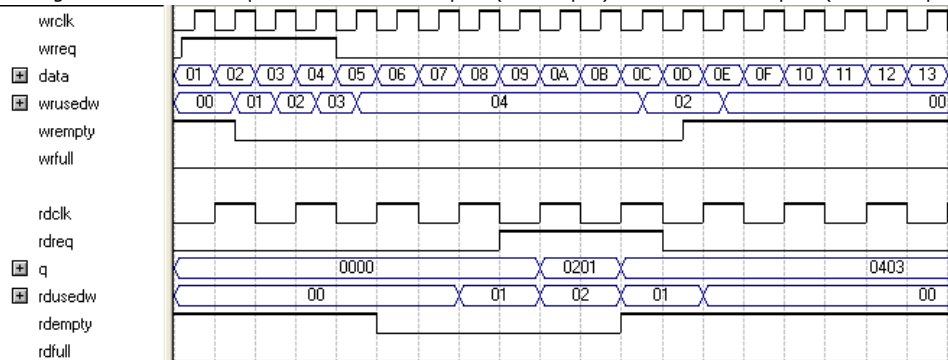



In this example, the read port is operating at half the frequency of the write port. Writing four 8-bit words to the FIFO buffer increases the `wrusedw` flag to four and the `rusedw` flag to two. Two 16-bit read operations empty the FIFO. The first and second 8-bit word written are equivalent to the LSB and MSB of the 16-bit output words, respectively. The `rdempty` signal stays asserted until enough words are written on the narrow write port to fill an entire word on the wide read port.

DCFIFO Timing Constraint Setting

The FIFO parameter editor provides the timing constraint setting for the DCFIFO function.

Table 13. DCFIFO Timing Constraint Setting Parameter in Intel Quartus Prime Software

Parameter	Description
Generate SDC File and disable embedded timing constraint ⁽²⁷⁾	<p>Allows you to bypass embedded timing constraints that uses <code>set_false_path</code> in the synchronization registers. A user configurable SDC file is generated automatically when DCFIFO is instantiated from the IP Catalog. New timing constraints consist of <code>set_net_delay</code>, <code>set_max_skew</code>, <code>set_min_delay</code> and <code>set_max_delay</code> are used to constraint the design properly.</p> <p><i>Note:</i> Intel recommends that you select this option for high frequency DCFIFO design to achieve timing closure. For more information, refer to User Configurable Timing Constraint on page 22.</p>

Embedded Timing Constraint

When using the Intel Quartus Prime Timing Analyzer with a design that contains a DCFIFO block apply the following false paths to avoid timing failures in the synchronization registers:

- For paths crossing from the write into the read domain, apply a false path assignment between the `delayed_wrptr_g` and `rs_dgwp` registers:

```
set_false_path -from [get_registers
{*dcfifo*delayed_wrptr_g[*]}] -to [get_registers
{*dcfifo*rs_dgwp*}]
```
- For paths crossing from the read into the write domain, apply a false path assignment between the `rdptr_g` and `ws_dgrp` registers:

```
set_false_path -from [get_registers {*dcfifo*rdptr_g[*]}] -to
[get_registers {*dcfifo*ws_dgrp*}]
```

The false path assignments are automatically added through the HDL-embedded Synopsis design constraint (SDC) commands when you compile your design. The related message is shown under the Timing Analyzer report.

Note: The constraints are internally applied but are not written to the Synopsis Design Constraint File (**.sdc**). To view the embedded-false path, type `report_sdc` in the console pane of the Timing Analyzer GUI.

⁽²⁷⁾ Parameter is available in Intel Quartus Prime software version 15.1 and later and applicable for Intel Arria 10 and Intel Cyclone 10 GX devices only. You can disable the embedded timing constraint with QSF setting in prior Intel Quartus Prime versions and other devices. Please refer to [KDB link](#) on the QSF assignment setting.



If you use the Intel Quartus Prime Timing Analyzer, the false paths are applied automatically for the DCFIFO.

Note: If the DCFIFO is implemented in ALMs, you can ignore the cross-domain timing violations from the data path of the DFFE array (that makes up the memory block) to the `q` output register. To ensure the `q` output is valid, sample the output only after the `rdempty` signal is deasserted.

Related Information

[The Intel Quartus Prime Timing Analyzer](#)

User Configurable Timing Constraint

DCFIFO contains multi-bit gray-coded asynchronous clock domain crossing (CDC) paths which derives the DCFIFO fill-level. In order for the logic to work correctly, the value of the multi-bit must always be sampled as 1-bit change at a given latching clock edge.

In the physical world, flip-flops do not have the same data and clock path insertion delays. It is important for you to ensure and check the 1-bit change property is properly set. You can confirm this using the Fitter and check using the Timing Analyzer.



Timing Analyzer will apply the following timing constraints for DCFIFO:

- Paths crossing from write into read domain are defined from the `delayed_wrptr_g` to `rs_dgwp` registers.

```
— set from_node_list [get_keepers $hier_path|dcfifo_component|  
auto_generated|delayed_wrptr_g*]
```

```
— set to_node_list [get_keepers $hier_path|dcfifo_component|  
auto_generated|rs_dgwp|dffpipe*|dffe*]
```

- Paths crossing from read into write domain are defined from the `rdptr_g` and `ws_dgrp` registers.

```
— set from_node_list [get_keepers $hier_path|dcfifo_component|  
auto_generated|*rdptr_g*]
```

```
— set to_node_list [get_keepers $hier_path|dcfifo_component|  
auto_generated|ws_dgrp|dffpipe*|dffe*]
```

- For the above paths which cross between write and read domain, the following assignments apply:

```
— set_max_skew -from $from_node_list -to $to_node_list  
-get_skew_value_from_clock_period src_clock_period -  
skew_value_multiplier 0.8
```

```
— set_min_delay -from $from_node_list -to $to_node_list -100
```

```
— set_max_delay -from $from_node_list -to $to_node_list 100
```

```
— set_net_delay -from $from_node_list -to $to_node_list -max  
-get_value_from_clock_period dst_clock_period -value_multiplier 0.8
```

- The following `set_net_delay` on cross clock domain nets are for metastability:.

```
— set from_node_mstable_list [get_keepers $hier_path|dcfifo_component|  
auto_generated|ws_dgrp|dffpipe*|dffe*]  
set to_node_mstable_list [get_keepers $hier_path|dcfifo_component|  
auto_generated|ws_dgrp|dffpipe*|dffe*]
```

```
— set from_node_mstable_list [get_keepers $hier_path|dcfifo_component|  
auto_generated|rs_dgwp|dffpipe*|dffe*]  
set to_node_mstable_list [get_keepers $hier_path|dcfifo_component|  
auto_generated|rs_dgwp|dffpipe*|dffe*]
```

```
— set_net_delay -from $from_node_list -to $to_node_list -max -  
get_value_from_clock_period dst_clock_period -value_multiplier 0.8
```

Timing Analyzer will apply the following timing constraints for mix-width DCFIFO:

- Paths crossing from write into read domain are defined from the `delayed_wrptr_g` to `rs_dgwp` registers.

```
— set from_node_list [get_keepers $hier_path|
dcfifo_mixed_widths_component|auto_generated|delayed_wrptr_g*]
```

```
— set to_node_list [get_keepers $hier_path|dcfifo_mixed_widths_component|
auto_generated|rs_dgwp|dffpipe*|dfffe*]
```

- Paths crossing from read into write domain are defined from the `rdpctr_g` and `ws_dgrp` registers.

```
— set from_node_list [get_keepers $hier_path|
dcfifo_mixed_widths_component|auto_generated|*rdpctr_g*]
```

```
— set to_node_list [get_keepers $hier_path|dcfifo_mixed_widths_component|
auto_generated|ws_dgrp|dffpipe*|dfffe*]
```

- For the above paths which cross between write and read domain, the following assignments apply:

```
— set_max_skew -from $from_node_list -to $to_node_list -
get_skew_value_from_clock_period src_clock_period -
skew_value_multiplier 0.8
```

```
— set_min_delay -from $from_node_list -to $to_node_list -100
```

```
— set_max_delay -from $from_node_list -to $to_node_list 100
```

```
— set_net_delay -from $from_node_list -to $to_node_list -max -
get_value_from_clock_period dst_clock_period -value_multiplier 0.8
```

- The following `set_net_delay` on cross clock domain nets are for metastability:

```
— set from_node_mstable_list [get_keepers $hier_path|
dcfifo_mixed_widths_component|auto_generated|ws_dgrp|dffpipe*|dfffe*]
set to_node_mstable_list [get_keepers $hier_path|
dcfifo_mixed_widths_component|auto_generated|ws_dgrp|dffpipe*|dfffe*]
```

```
— set from_node_mstable_list [get_keepers $hier_path|
dcfifo_mixed_widths_component|auto_generated|rs_dgwp|dffpipe*|dfffe*]
set to_node_mstable_list [get_keepers $hier_path|
dcfifo_mixed_widths_component|auto_generated|rs_dgwp|dffpipe*|dfffe*]
```

```
— set_net_delay -from $from_node_list -to $to_node_list -max -
get_value_from_clock_period dst_clock_period -value_multiplier 0.8
```



SDC Commands

Table 14. SDC Commands usage in the Intel Quartus Prime Fitter and Timing Analyzer

These SDC descriptions provided are overview for DCFIFO use case. For the exact SDC details, refer to the Intel Quartus Prime Timing Analyzer chapter in the Intel Quartus Prime Pro Edition Handbook.

SDC Command	Fitter	Timing Analyzer	Recommended Settings
set_max_skew ⁽²⁸⁾	To constraint placement and routing of flops in the multi-bit CDC paths to meet the specified skew requirement among bits.	To analyze whether the specified skew requirement is fully met. Both clock and data paths are taken into consideration.	Set to less than 1 launch clock.
set_net_delay	Similar to set_max_skew but without taking clock skews into considerations. To ensure the crossing latency is bounded.	To analyze whether the specified net delay requirement is fully met. Clock paths are not taken into consideration.	This is currently set to be less than 1 latch clock. ⁽²⁹⁾
set_min_delay/ set_max_delay	To relax fitter effort by mimicking the set_false_path command but without overriding other SDCs. ⁽³⁰⁾	To relax timing analysis for the setup/hold checks to not fail. ⁽³¹⁾	This is currently set to 100ns/-100ns for max/min. ⁽³²⁾

Related Information

[The Intel Quartus Prime Timing Analyzer](#)

Coding Example for Manual Instantiation

This section provides a Verilog HDL coding example to create an instance of the DCFIFO. It is not a complete coding for you to compile, but it provides a guideline and some comments for the required structure of the instantiation. You can use the same structure to instantiate other IP cores but only with the ports and parameters that are applicable to the IP cores you instantiated.

Example 1. Verilog HDL Coding Example to Instantiate the DCFIFO

```
//module declaration
module dcfifo8x32 (aclr, data, ..... ,wfull);
//Module's port declarations
input aclr;
input [31:0] data;
```

-
- (28) It can have significant compilation time impact in older Quartus versions without Timing Analyzer 2.
 - (29) For advanced users, you can fine-tune the value based on your design. For instance, if the designs are able to tolerate longer crossing latency (full and empty status will be delayed), this can be relaxed.
 - (30) Without set_false_path (which has the highest precedence and may result in very long insertion delays), Fitter will attempt to meet the default setup/hold which is extremely over constraint.
 - (31) Without set_false_path, the CDC paths will be analyzed for default setup/hold, which is extremely over constraint.
 - (32) Expect an approximately 100ns delay when you observe CDC paths compared to set_false_path.

```

.
.
output wrfull;
//Module's data type declarations and assignments
wire rdempty_w;
.
.
wire wrfull = wrfull_w; wire [31:0] q = q_w;
/*Instantiates dcfifo megafunction. Must declare all the ports available from
the megafunction and
define the connection to the module's ports.
Refer to the ports specification from the user guide for more information about
the megafunction's
ports*/
//syntax: <megafunction's name> <given an instance name>
dcfifo inst1 (
//syntax: .<dcfifo's megafunction's port>(<module's port/wire>)
.wrclk (wrclk),
.rdclk (rdclk),
.
.
.wrusedw ()); //left the output open if it's not used
/*Start with the keyword "defparam", defines the parameters and value
assignments. Refer to
parameters specifications from the user guide for more information about the
megafunction's
parameters*/
defparam
//syntax: <instance name>.<parameter> = <value>
inst1.intended_device_family = "Stratix III",
inst1.lpm_numwords = 8,
.
.
inst1.wrsync_delaypipe = 4;
endmodule

```

Design Example

In this design example, the data from the ROM is required to be transferred to the RAM. Assuming the ROM and RAM are driven by non-related clocks, you can use the DCFIFO to transfer the data between the asynchronous clock domains effectively.

Figure 9. Component Blocks and Signal Interaction

This figure shows the component blocks and their signal interactions.

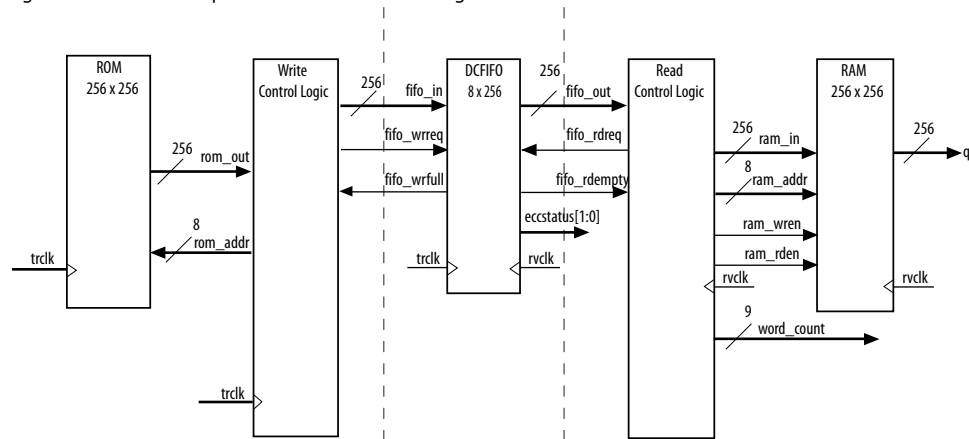

Note: The DCFIFO functions are with ECC feature enabled and implemented using M20K.



Note: Both the DCFIFO functions are only capable of handling asynchronous data transferring issues (metastable effects). You must have a controller to govern and monitor the data buffering process between the ROM, DCFIFO, and RAM. This design example provides you the write control logic (`write_control_logic.v`), and the read control logic (`read_control_logic.v`) which are compiled with the DCFIFO specifications that control the valid write or read request to or from the DCFIFO.

Note: This design example is validated with its functional behavior, but without timing analysis and gate-level simulation. The design coding such as the state machine for the write and read controllers may not be optimized. The intention of this design example is to show the use of the IP core, particularly on its control signal in data buffering application, rather than the design coding and verification processes.

To obtain the DCFIFO settings in this design example, refer to the parameter settings from the design file (`dcfifo8x32.v`).

The following sections include separate simulation waveforms to describe how the write and read control logics generate the control signal with respect to the signal received from the DCFIFO.

Note: For better understanding, refer to the signal names in the above figure when you go through the descriptions for the simulation waveforms.

Note: All signals in the following figures and tables have the following numerical format:

- Signal values in binary format: `reset`, `trclk`, `fifo_wrreq`, `fifo_wrfull`
- Signal values in HEX format: `rom_addr`, `rom_out`, `fifo_in`

Figure 10. Initial Write Operation to the DCFIFO Function

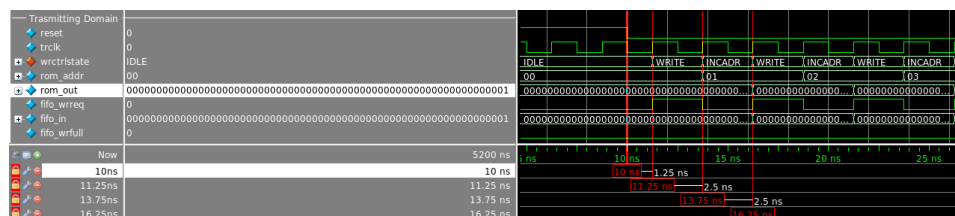

Table 15. Initial Write Operation to the DCFIFO Function Waveform Description

State	Description
IDLE	Before reaching 10 ns, the <code>reset</code> signal is high and causes the write controller to be in the IDLE state. In the IDLE state, the write controller drives the <code>fifo_wrreq</code> signal to low, and requests the data to be read from <code>rom_addr=00</code> . The ROM is configured to have an unregistered output, so that the <code>rom_out</code> signal immediately shows the data from the <code>rom_addr</code> signal regardless of the reset. This shortens the latency because the <code>rom_out</code> signal is connected directly to the <code>fifo_in</code> signal, which is a registered

continued...



Figure 12. Write Operation when DCFIFO is FULL

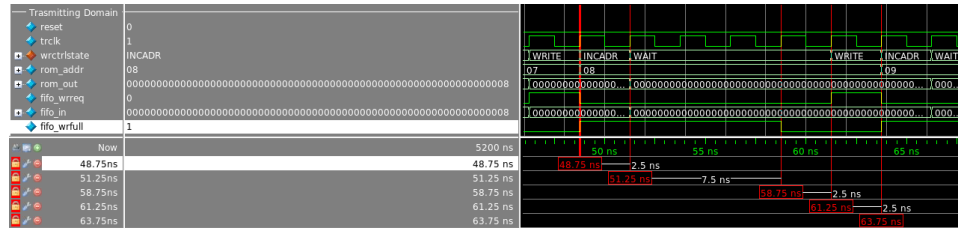

Table 17. Write Operation when DCFIFO is FULL Waveform Description

State	Description
INCADR	When the write controller is in the INCADR state, and the fifo_wrfull signal is asserted, the write controller transitions to the WAIT state in the next rising clock edge.
WAIT	In the WAIT state, the write controller holds the rom_addr signal (08) so that the respective data is written into the DCFIFO when the write controller transitions to the WRITE state. The write controller stays in WAIT state if the fifo_wrfull signal is still high. When the fifo_wrfull is low, the write controller always transitions from the WAIT state to the WRITE state at the next rising clock edge.
WRITE	In the WRITE state, then only the write controller drives the fifo_wrrreq signal to high, and requests for write operation to write the data from the previously held address (08) into the DCFIFO. It always transitions to the INCADR state in the next rising clock edge, if the rom_addr signal has not yet increased to ff.
--	The same state transition continues as stated in INCADR, WAIT, and WRITE states, if the fifo_wrfull signal is high.

Figure 13. Completion of Data Transfer from ROM to DCFIFO

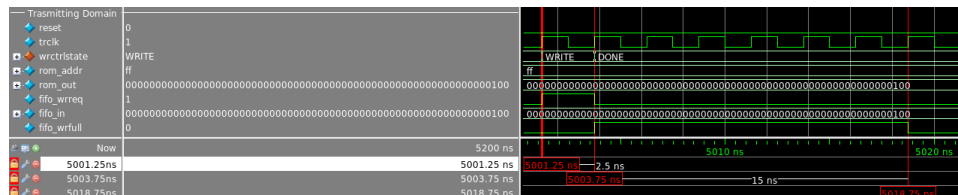

Table 18. Completion of Data Transfer from ROM to DCFIFO Waveform Description

State	Description
WRITE	When the write controller is in the WRITE state, and rom_addr = ff, the write controller drives the fifo_wrrreq signal to high to request for last write operation to DCFIFO. The data 100 is the last data stored in the ROM to be written into the DCFIFO. In the next rising clock edge, the write controller transitions to the DONE state.
DONE	In the DONE state, the write controller drives the fifo_wrrreq signal to low.
--	The fifo_wrfull signal is deasserted because the read controller in the receiving domain continuously performs the read operation. However, the fifo_wrfull signal is only deasserted sometime after the read request from the receiving domain. This is due to the latency in the DCFIFO (rdreq signal to wrfull signal).



which then transfers the data to the read domain, and on to the destination bus registers.

Because of the skew for `bit[0]`, the destination bus registers receive the following sequence:

```
000,  
000,  
011,  
011,  
110....
```

Because of the skew, a 2-bit transition occurs. This sequence is acceptable if the timing is met. If the 2-bit transition occurs and both bits violate timing, it may result in the counter bus settled at a future or previous counter value, which will corrupt the DCFIFO.

Therefore, the skew must be within a certain skew to ensure that the sequence is not corrupted.

Note: Use the `report_max_skew` and `report_net_delay` reports in the Timing Analyzer for timing verification if you use the User Configurable Timing Constraint. For Embedded Timing Constraint, use the `skew_report.tcl` to analyze the actual skew and required skew in your design.

Related Information

[skew_report.tcl](#)

Guidelines for Embedded Memory ECC Feature

The Intel Arria 10 and Intel Cyclone 10 GX FIFO Intel FPGA IP cores support embedded memory ECC for M20K memory blocks. The built-in ECC feature in the Intel Arria 10 and Intel Cyclone 10 GX devices can perform:

- Single-error detection and correction
- Double-adjacent-error detection and correction
- Triple-adjacent-error detection

You can turn on FIFO Embedded ECC feature by enabling `enable_ecc` parameter in the FIFO Intel FPGA IP GUI.

Note: Embedded memory ECC feature is only available for M20K memory block type.

Note: The embedded memory ECC supports variable data width. When ECC is enabled, RAM combines multiple M20K blocks in the configuration of 32 (width) x 512 (depth) to fulfill your instantiation. The unused data width will be tied to the V_{CC} internally.

Note: The embedded memory ECC feature is not supported in mixed-width mode.

Figure 15. ECC Option in FIFO Intel FPGA IP GUI

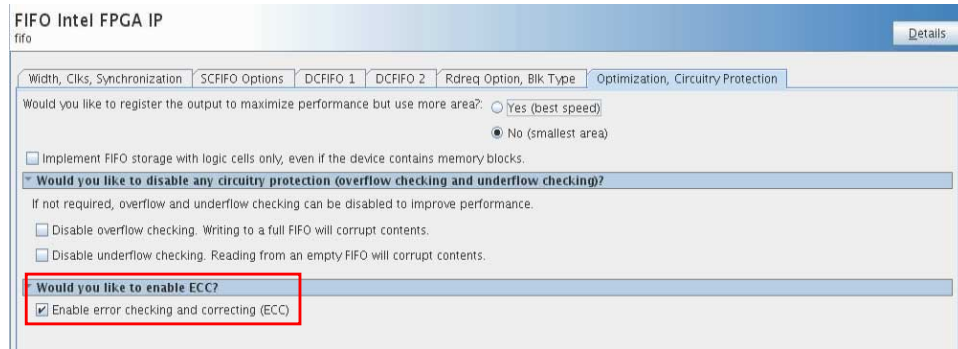

When you enable the ECC feature, a 2-bit wide error correction status port (`eccstatus[1:0]`) will be created in the generated FIFO entity. These status bits indicate whether the data that is read from the memory has an error in single-bit with correction, fatal error with no correction, or no error bit.

- 00: No error
- 01: Illegal
- 10: A correctable error occurred and the error has been corrected at the outputs; however, the memory array has not been updated.
- 11: An uncorrectable error occurred and uncorrectable data appears at the output

Related Information

[Error Correction Code in Embedded Memory User Guide](#)

FIFO Intel FPGA IP User Guide Archives

If an IP core version is not listed, the user guide for the previous IP core version applies.

IP Core Version	User Guide
17.1	SCFIFO and DCFIFO IP Cores User Guide
17.0	SCFIFO and DCFIFO IP Cores User Guide
16.0	SCFIFO and DCFIFO IP Cores User Guide
15.1	SCFIFO and DCFIFO IP Cores User Guide
14.1	SCFIFO and DCFIFO IP Cores User Guide



Document Revision History for the FIFO Intel FPGA IP User Guide

Document Version	Intel Quartus Prime Version	Changes
2020.12.14	18.0	Updated the description in the Gray-Code Counter Transfer at the Clock Domain Crossing topic of the FIFO section.
2019.11.21	18.0	<ul style="list-style-type: none"> Added <code>lpm_hint</code> to Table: <i>FIFO Parameters</i>. Updated the description in the <i>Recovery and Removal Timing Violation Warnings when Compiling a DCFIFO</i> section. Remove references to Intel Stratix 10 devices throughout the document. Refer to the <i>FIFO Intel FPGA IP section of the Intel Stratix 10 Embedded Memory User Guide</i> for more information.
2018.09.24	18.0	<ul style="list-style-type: none"> Updated Table: <i>Input and Output Ports Description</i> to include a note for <code>usedw</code>, <code>wrusedw</code>, and <code>rdusedw</code> ports. Updated Table: <i>FIFO Parameters</i> to update the footnotes for <code>lpm_widthu_r</code>, <code>delay_wrusedw</code>, <code>read_aclr_synth</code>, and <code>almost_empty_value</code>.
2018.08.01	18.0	Updated the <i>DCFIFO Timing Constraint Setting</i> topic to add a note to recommend selecting the Generate SDC File and disable embedded timing constraint option for high frequency DCFIFO design.
2018.07.02	18.0	Updated the <i>VHDL LIBRARY-USE Declaration</i> topic to correct the VHDL Library declaration example from <code>USE altera_mf altera_mf_components.all;</code> to <code>USE altera_mf.altera_mf_components.all;</code>
2018.05.07	18.0	<ul style="list-style-type: none"> Renamed the document as <i>FIFO Intel FPGA IP User Guide</i>. Renamed "SCFIFO and DCFIFO" IP cores to "FIFO Intel FPGA IP" core as per Intel rebranding. Updated the description for <code>ram_block_type</code> in the <i>FIFO Parameters</i> topic. Updated Table: <i>Device Family Support for Width Ratios</i> to include valid width ratios for Intel Stratix 10 devices. Added a note to <i>FIFO Synchronous Clear and Asynchronous Clear Effect</i> topic to clarify that for Intel Stratix 10 devices, asserting <code>aclr</code> or <code>sclr</code> upon power-up guarantee correct functionality. Updated the note in Table: <i>DCFIFO Timing Constraint Setting Parameter in Intel Quartus Prime Software</i>. Updated <i>Guidelines for Embedded Memory ECC Feature</i> topic. Updated Figure: <i>ECC Option in FIFO Intel FPGA IP GUI</i>. Updated for latest branding standards. Made editorial updates throughout the document.

Date	Version	Changes
November 2017	2017.11.06	<ul style="list-style-type: none"> Added support for Intel Stratix 10, Intel Cyclone 10 LP, and Intel Cyclone 10 GX devices. Updated the LE Implemented RAM Mode for SCFIFO and DCFIFO table to correct output latency for <code>wrreq</code> to <code>empty</code>. Updated the SCFIFO and DCFIFO Parameters to include <code>add_usedw_msb_bit</code> register signal. Updated for latest branding standards.
May 2017	2017.05.08	<ul style="list-style-type: none"> Rebranded as Intel. Added a table listing the device family support for width ratio in the Different Input and Output Width topic. Minor typographical corrections and stylistic changes.
<i>continued...</i>		



Date	Version	Changes
August 2016	2016.08.29	<ul style="list-style-type: none"> Added note to <i>Configuration Methods</i> stating that <code>scfifo</code> and <code>dcfifo</code> cannot be used for FIFO Qsys entity name. Added note to <code>almost_empty</code> in <i>SCFIFO and DCFIFO Signals</i> table. Added <i>SCFIFO ALMOST_EMPTY Functional Timing</i> section.
May 2016	2016.05.30	Added note about using <code>skew_report.tcl</code> if Embedded Timing Constraint is used and <code>report_max_skew</code> .
May 2016	2016.05.02	<ul style="list-style-type: none"> Added list of user configurable constraint commands and descriptions in <i>Constrain Commands</i>. Added timing constraints for mixed-width DCFIFO. Upgraded design example with ECC feature enabled. Added <i>Guidelines for Embedded Memory ECC Feature</i> section. Removed 32-bit width FIFO limitation for <code>eccstatus</code> signal and <code>enable_ecc</code> parameter. Added FIFO IP core parameter editor directory in IP catalog in <i>Configuration Methods</i> section.
November 2015	2015.11.02	<ul style="list-style-type: none"> Added <i>User Configurable Timing Constraint</i>. Added <i>DCFIFO Timing Constraint Setting</i>. Renamed <i>Constraint Settings</i> to <i>Embedded Constraint Settings</i>. Moved normal and show-ahead description from parameter table to <i>SCFIFO and DCFIFO Show-Ahead Mode</i> subsection. Added normal and show-ahead waveform for comparison. Added <code>eccstatus</code> port in block diagram and port table list available in Quartus II 15.1 release. Added <code>enable_ecc</code> parameter in <i>SCFIFO and DCFIFO Parameters</i>. Updated Verilog HDL prototype directory. Corrected <code>lpm_numwords</code> register equation. Updated <i>Example 1: Verilog HDL Coding Example to Instantiate the DCFIFO IP Core</i>.
December 2014	2014.12.17	<ul style="list-style-type: none"> Clarified that there are no minimum number of clock cycles for <code>aclr</code> signals that must remain active. Added Recovery and Removal Timing Violation Warnings when Compiling a DCFIFO Megafunction section. Removed a note about ignoring any recovery and removal violation reported in the TimeQuest timing analyzer that represent transfers from the <code>aclr</code> to the read side clock domain in Synchronous Clear and Asynchronous Clear Effect section.
May 2013	8.2	<ul style="list-style-type: none"> Updated Table 8 on page 20 to state that both the read and write pointers reset to zero upon assertion of either the <code>sclr</code> or <code>aclr</code> signal. Updated Table 1 on page 7 to note that the <code>wrusedw</code>, <code>rdusedw</code>, <code>wrfull</code>, <code>rdfull</code>, <code>wrempty</code> and <code>rdempty</code> values are subject to the latencies listed in Table 5 on page 18.
August 2012	8.1	<ul style="list-style-type: none"> Included a link to <code>skew_report.tcl</code> "Gray-Code Counter Transfer at the Clock Domain Crossing" on page 29.
August 2012	8.0	<ul style="list-style-type: none"> Updated "DCFIFO" on page 3, "Ports Specifications" on page 6, "Functional Timing Requirements" on page 14, "Synchronous Clear and Asynchronous Clear Effect" on page 20. Updated Table 1 on page 7, Table 2 on page 10, Table 9 on page 21. Added Table 4 on page 16. Renamed and updated "DCFIFO Clock Domain Crossing Timing Violation" to "Gray-Code Counter Transfer at the Clock Domain Crossing" on page 29.
<i>continued...</i>		



Date	Version	Changes
February 2012	7.0	<ul style="list-style-type: none"> Updated the notes for Table 4 on page 16. Added the "DCFIFO Clock Domain Crossing Timing Violation" section.
September 2010	6.2	Added prototype and component declarations.
January 2010	6.1	<ul style="list-style-type: none"> Updated "Functional Timing Requirements" section. Minor changes to the text.
September 2009	6.0	<ul style="list-style-type: none"> Replaced "FIFO Megafunction Features" section with "Configuration Methods". Updated "Input and Output Ports". Added "Parameter Specifications", "Output Status Flags and Latency", "Metastability Protection and Related Options", "Constraint Settings", "Coding Example for Manual Instantiation", and "Design Example".
February 2009	5.1	Minor update in Table 8 on page 17.
January 2009	5.0	Complete re-write of the user guide.
May 2007	4.0	<ul style="list-style-type: none"> Added support for Arria GX devices. Updated for new GUI. Added six design examples in place of functional description. Reorganized and updated Chapter 3 to have separate tables for the SCFIFO and DCFIFO megafunctions. Added Referenced Documents section.
March 2007	3.3	<ul style="list-style-type: none"> Minor content changes, including adding Stratix III and Cyclone III information Re-took screenshots for software version 7.0
September 2005	3.2	Minor content changes.