

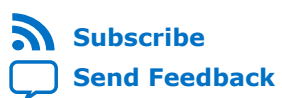

FFT IP Core

User Guide

Updated for Intel® Quartus® Prime Design Suite: **17.1**



UG-FFT | 2017.11.06

Latest document on the web: [PDF](#) | [HTML](#)



Contents

- 1. About This IP Core..... 4**
 - 1.1. Intel® DSP IP Core Features.....4
 - 1.2. FFT IP Core Features.....5
 - 1.3. General Description.....5
 - 1.3.1. Fixed Transform Size FFT..... 5
 - 1.3.2. Variable Streaming FFT.....6
 - 1.4. DSP IP Core Device Family Support.....6
 - 1.5. DSP IP Core Verification.....7
 - 1.6. FFT IP Core Release Information.....7
 - 1.7. Performance and Resource Utilization.....7

- 2. FFT IP Core Getting Started..... 13**
 - 2.1. Installing and Licensing Intel FPGA IP Cores..... 13
 - 2.1.1. Intel FPGA IP Evaluation Mode..... 13
 - 2.1.2. FFT IP Core Intel FPGA IP Evaluation Mode Timeout Behavior.....16
 - 2.2. IP Catalog and Parameter Editor..... 16
 - 2.3. Generating IP Cores (Intel Quartus Prime Pro Edition).....17
 - 2.3.1. IP Core Generation Output (Intel Quartus Prime Pro Edition).....19
 - 2.4. Generating IP Cores (Intel Quartus Prime Standard Edition)..... 21
 - 2.4.1. IP Core Generation Output (Intel Quartus Prime Standard Edition).....22
 - 2.5. Simulating Intel FPGA IP Cores..... 23
 - 2.5.1. Simulating the Fixed-Transform FFT IP Core in the MATLAB Software.....24
 - 2.5.2. Simulating the Variable Streaming FFT IP Core in the MATLAB Software..... 24
 - 2.6. DSP Builder for Intel FPGAs Design Flow..... 25

- 3. FFT IP Core Functional Description..... 26**
 - 3.1. Fixed Transform FFTs.....26
 - 3.2. Variable Streaming FFTs.....26
 - 3.2.1. Fixed-Point Variable Streaming FFTs..... 27
 - 3.2.2. Floating-Point Variable Streaming FFTs.....27
 - 3.3. FFT Processor Engines..... 27
 - 3.3.1. Quad-Output FFT Engine.....28
 - 3.3.2. Single-Output FFT Engine.....28
 - 3.4. I/O Data Flow.....29
 - 3.4.1. Streaming FFT.....29
 - 3.4.2. Variable Streaming.....31
 - 3.4.3. Buffered Burst.....34
 - 3.4.4. Burst.....36
 - 3.5. FFT IP Core Parameters..... 37
 - 3.6. FFT IP Core Interfaces and Signals.....38
 - 3.6.1. Avalon-ST Interfaces in DSP IP Cores..... 38
 - 3.6.2. FFT IP Core Avalon-ST Signals.....39

- 4. Block Floating Point Scaling..... 42**
 - 4.1. Possible Exponent Values..... 43
 - 4.2. Implementing Scaling.....44
 - 4.2.1. Example of Scaling.....44
 - 4.3. Unity Gain in an IFFT+FFT Pair..... 46



5. Document Revision History.....	48
A. FFT IP Core User Guide Document Archive.....	50

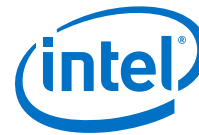

1. About This IP Core

Related Information

- [FFT IP Core User Guide Document Archive](#) on page 50
Provides a list of user guides for previous versions of the FFT IP core.
- [Introduction to Intel FPGA IP Cores](#)
Provides general information about all Intel FPGA IP cores, including parameterizing, generating, upgrading, and simulating IP cores.
- [Creating Version-Independent IP and Qsys Simulation Scripts](#)
Create simulation scripts that do not require manual updates for software or IP version upgrades.
- [Project Management Best Practices](#)
Guidelines for efficient management and portability of your project and IP files.

1.1. Intel® DSP IP Core Features

- Avalon® Streaming (Avalon-ST) interfaces
- DSP Builder for Intel® FPGAs ready
- Testbenches to verify the IP core
- IP functional simulation models for use in Intel-supported VHDL and Verilog HDL simulators



1.2. FFT IP Core Features

- Bit-accurate MATLAB models
- Variable streaming FFT:
 - Single-precision floating-point or fixed-point representation
 - Radix-4, mixed radix-4/2 implementations (for floating-point FFT), and radix-2² single delay feedback implementation (for fixed-point FFT)
 - Input and output orders: natural order, or digit-reversed, and DC-centered (-N/2 to N/2)
 - Reduced memory requirements
 - Support for 8 to 32-bit data and twiddle width (fixed-point FFTs)
- Fixed transform size FFT that implements block floating-point FFTs and maintains the maximum dynamic range of data during processing (not for variable streaming FFTs)
 - Multiple I/O data flow options: streaming, buffered burst, and burst
 - Uses embedded memory
 - Maximum system clock frequency more than 300 MHz
 - Optimized to use Stratix series DSP blocks and TriMatrix memory
 - High throughput quad-output radix 4 FFT engine
 - Support for multiple single-output and quad-output engines in parallel
- User control over optimization in DSP blocks or in speed in Stratix V devices, for streaming, buffered burst, burst, and variable streaming fixed-point FFTs
- Avalon Streaming (Avalon-ST) compliant input and output interfaces
- Parameterization-specific VHDL and Verilog HDL testbench generation
- Transform direction (FFT/IFFT) specifiable on a per-block basis

1.3. General Description

The FFT IP core is a high performance, highly-parameterizable Fast Fourier transform (FFT) processor. The FFT IP core implements a complex FFT or inverse FFT (IFFT) for high-performance applications.

The FFT MegaCore function implements:

- Fixed transform size FFT
- Variable streaming FFT

1.3.1. Fixed Transform Size FFT

The fixed transform FFT implements a radix-2/4 decimation-in-frequency (DIF) FFT fixed-transform size algorithm for transform lengths of 2^m where $6 \leq m \leq 16$. This FFT uses block-floating point representations to achieve the best trade-off between maximum signal-to-noise ratio (SNR) and minimum size requirements.

The fixed transform FFT accepts a two's complement format complex data vector of length N inputs, where N is the desired transform length in natural order. The function outputs the transform-domain complex vector in natural order. The FFT produces an



accumulated block exponent to indicate any data scaling that has occurred during the transform to maintain precision and maximize the internal signal-to-noise ratio. You can specify the transform direction on a per-block basis using an input port.

1.3.2. Variable Streaming FFT

The variable streaming FFT implements two different types of FFT. The variable streaming FFTs implement either a radix-2² single delay feedback FFT, using a fixed-point representation, or a mixed radix-4/2 FFT, using a single precision floating point representation. After you select your FFT type, you can configure your FFT variation during runtime to perform the FFT algorithm for transform lengths of 2m where $3 \leq m \leq 18$.

The fixed-point representation grows the data widths naturally from input through to output thereby maintaining a high SNR at the output. The single precision floating-point representation allows a large dynamic range of values to be represented while maintaining a high SNR at the output.

The order of the input data vector of size N can be natural or digit-reversed, or -N/2 to N/2 (DC-centered). The fixed-point representation supports a natural or DC-centered order and the floating point representation supports a natural, digit-reversed order. The FFT outputs the transform-domain complex vector in natural or digit-reversed order. You can specify the transform direction on a per-block basis using an input port.

1.4. DSP IP Core Device Family Support

Intel offers the following device support levels for Intel FPGA IP cores:

- Advance support—the IP core is available for simulation and compilation for this device family. FPGA programming file (.poef) support is not available for Quartus Prime Pro Stratix 10 Edition Beta software and as such IP timing closure cannot be guaranteed. Timing models include initial engineering estimates of delays based on early post-layout information. The timing models are subject to change as silicon testing improves the correlation between the actual silicon and the timing models. You can use this IP core for system architecture and resource utilization studies, simulation, pinout, system latency assessments, basic timing assessments (pipeline budgeting), and I/O transfer strategy (data-path width, burst depth, I/O standards tradeoffs).
- Preliminary support—Intel verifies the IP core with preliminary timing models for this device family. The IP core meets all functional requirements, but might still be undergoing timing analysis for the device family. You can use it in production designs with caution.
- Final support—Intel verifies the IP core with final timing models for this device family. The IP core meets all functional and timing requirements for the device family. You can use it in production designs.

Table 1. DSP IP Core Device Family Support

Device Family	Support
Arria® II GX	Final
Arria II GZ	Final
Arria V	Final
<i>continued...</i>	



Device Family	Support
Intel Arria 10	Final
Cyclone® IV	Final
Cyclone V	Final
Intel Cyclone 10	Final
Intel MAX® 10 FPGA	Final
Stratix® IV GT	Final
Stratix IV GX/E	Final
Stratix V	Final
Intel Stratix 10	Advance
Other device families	No support

1.5. DSP IP Core Verification

Before releasing a version of an IP core, Intel runs comprehensive regression tests to verify its quality and correctness. Intel generates custom variations of the IP core to exercise the various parameter options and thoroughly simulates the resulting simulation models with the results verified against master simulation models.

1.6. FFT IP Core Release Information

Table 2. FFT IP Core Release Information

Item	Description
Version	17.1
Release Date	November 2017
Ordering Code	IP-FFT

Related Information

- [Intel FPGA IP Release Notes](#)
- [Errata for FIR II IP core in the Knowledge Base](#)

1.7. Performance and Resource Utilization

Table 3. Performance and Resource Utilization

Typical performance using the Quartus Prime software with the Arria V (5AGXFB3H4F40C4), Cyclone V (5CGXFC7D6F31C6), and Stratix V (5SGSMD4H2F35C2) devices

Device	Parameters			ALM	DSP Blocks	Memory		Registers		f _{MAX} (MHz)
	Type	Length	Engines			M10K	M20K	Primary	Secondary	
Arria V	Buffered Burst	1,024	1	1,572	6	16	--	3,903	143	275
Arria V	Buffered Burst	1,024	2	2,512	12	30	--	6,027	272	274

continued...



Device	Parameters			ALM	DSP Blocks	Memory		Registers		f _{MAX} (MHz)
	Type	Length	Engines			M10K	M20K	Primary	Secondary	
Arria V	Buffered Burst	1,024	4	4,485	24	59	--	10,765	426	262
Arria V	Buffered Burst	256	1	1,532	6	16	--	3,713	136	275
Arria V	Buffered Burst	256	2	2,459	12	30	--	5,829	246	245
Arria V	Buffered Burst	256	4	4,405	24	59	--	10,539	389	260
Arria V	Buffered Burst	4,096	1	1,627	6	59	--	4,085	130	275
Arria V	Buffered Burst	4,096	2	2,555	12	59	--	6,244	252	275
Arria V	Buffered Burst	4,096	4	4,526	24	59	--	10,986	438	265
Arria V	Burst Quad Output	1,024	1	1,565	6	8	--	3,807	147	273
Arria V	Burst Quad Output	1,024	2	2,497	12	14	--	5,952	225	275
Arria V	Burst Quad Output	1,024	4	4,461	24	27	--	10,677	347	257
Arria V	Burst Quad Output	256	1	1,527	6	8	--	3,610	153	272
Arria V	Burst Quad Output	256	2	2,474	12	14	--	5,768	233	275
Arria V	Burst Quad Output	256	4	4,403	24	27	--	10,443	437	257
Arria V	Burst Quad Output	4,096	1	1,597	6	27	--	3,949	151	275
Arria V	Burst Quad Output	4,096	2	2,551	12	27	--	6,119	223	275
Arria V	Burst Quad Output	4,096	4	4,494	24	27	--	10,844	392	256
Arria V	Burst Single Output	1,024	1	672	2	6	--	1,488	101	275
Arria V	Burst Single Output	1,024	2	994	4	10	--	2,433	182	275
Arria V	Burst Single Output	256	1	636	2	3	--	1,442	95	275
Arria V	Burst Single Output	256	2	969	4	8	--	2,375	152	275
Arria V	Burst Single Output	4,096	1	702	2	19	--	1,522	126	270
Arria V	Burst Single Output	4,096	2	1,001	4	25	--	2,521	156	275
Arria V	Streaming	1,024	—	1,880	6	20	--	4,565	167	275

continued...

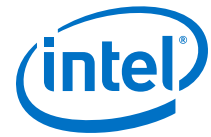

Device	Parameters			ALM	DSP Blocks	Memory		Registers		f _{MAX} (MHz)
	Type	Length	Engines			M10K	M20K	Primary	Secondary	
Arria V	Streaming	256	—	1,647	6	20	--	3,838	137	275
Arria V	Streaming	4,096	—	1,819	6	71	--	4,655	137	275
Arria V	Variable Streaming Floating Point	1,024	—	11,195	48	89	--	18,843	748	163
Arria V	Variable Streaming Floating Point	256	—	8,639	36	62	--	15,127	609	161
Arria V	Variable Streaming Floating Point	4,096	—	13,947	60	138	--	22,598	854	162
Arria V	Variable Streaming	1,024	—	2,535	11	14	--	6,269	179	223
Arria V	Variable Streaming	256	—	1,913	8	8	--	4,798	148	229
Arria V	Variable Streaming	4,096	—	3,232	15	31	--	7,762	285	210
Cyclone V	Buffered Burst	1,024	1	1,599	6	16	--	3,912	114	226
Cyclone V	Buffered Burst	1,024	2	2,506	12	30	--	6,078	199	219
Cyclone V	Buffered Burst	1,024	4	4,505	24	59	--	10,700	421	207
Cyclone V	Buffered Burst	256	1	1,528	6	16	--	3,713	115	227
Cyclone V	Buffered Burst	256	2	2,452	12	30	--	5,833	211	232
Cyclone V	Buffered Burst	256	4	4,487	24	59	--	10,483	424	221
Cyclone V	Buffered Burst	4,096	1	1,649	6	59	--	4,060	138	223
Cyclone V	Buffered Burst	4,096	2	2,555	12	59	--	6,254	199	227
Cyclone V	Buffered Burst	4,096	4	4,576	24	59	--	10,980	377	214
Cyclone V	Burst Quad Output	1,024	1	1,562	6	8	--	3,810	122	225
Cyclone V	Burst Quad Output	1,024	2	2,501	12	14	--	5,972	196	231
Cyclone V	Burst Quad Output	1,024	4	4,480	24	27	--	10,643	372	216
Cyclone V	Burst Quad Output	256	1	1,534	6	8	--	3,617	120	226

continued...



Device	Parameters			ALM	DSP Blocks	Memory		Registers		f _{MAX} (MHz)
	Type	Length	Engines			M10K	M20K	Primary	Secondary	
Cyclone V	Burst Quad Output	256	2	2,444	12	14	--	5,793	153	224
Cyclone V	Burst Quad Output	256	4	4,443	24	27	--	10,402	379	223
Cyclone V	Burst Quad Output	4,096	1	1,590	6	27	--	3,968	120	237
Cyclone V	Burst Quad Output	4,096	2	2,547	12	27	--	6,135	209	227
Cyclone V	Burst Quad Output	4,096	4	4,512	24	27	--	10,798	388	210
Cyclone V	Burst Single Output	1,024	1	673	2	6	--	1,508	83	222
Cyclone V	Burst Single Output	1,024	2	984	4	10	--	2,475	126	231
Cyclone V	Burst Single Output	256	1	639	2	3	--	1,382	159	229
Cyclone V	Burst Single Output	256	2	967	4	8	--	2,353	169	240
Cyclone V	Burst Single Output	4,096	1	695	2	19	--	1,540	105	237
Cyclone V	Burst Single Output	4,096	2	1,009	4	25	--	2,536	116	240
Cyclone V	Streaming	1,024	—	1,869	6	20	--	4,573	132	211
Cyclone V	Streaming	256	—	1,651	6	20	--	3,878	85	226
Cyclone V	Streaming	4,096	—	1,822	6	71	--	4,673	124	199
Cyclone V	Variable Streaming Floating Point	1,024	—	11,184	48	89	--	18,830	628	133
Cyclone V	Variable Streaming Floating Point	256	—	8,611	36	62	--	15,156	467	133
Cyclone V	Variable Streaming Floating Point	4,096	—	13,945	60	138	--	22,615	701	132
Cyclone V	Variable Streaming	1,024	—	2,533	11	14	--	6,254	240	179
Cyclone V	Variable Streaming	256	—	1,911	8	8	--	4,786	176	180
Cyclone V	Variable Streaming	4,096	—	3,226	15	31	--	7,761	320	176
Stratix V	Buffered Burst	1,024	1	1,610	6	--	16	4,141	107	424
Stratix V	Buffered Burst	1,024	2	2,545	12	--	30	6,517	170	427

continued...



Device	Parameters			ALM	DSP Blocks	Memory		Registers		f _{MAX} (MHz)
	Type	Length	Engines			M10K	M20K	Primary	Secondary	
Stratix V	Buffered Burst	1,024	4	4,554	24	--	59	11,687	250	366
Stratix V	Buffered Burst	256	1	1,546	6	--	16	3,959	110	493
Stratix V	Buffered Burst	256	2	2,475	12	--	30	6,314	134	440
Stratix V	Buffered Burst	256	4	4,480	24	--	59	11,477	281	383
Stratix V	Buffered Burst	4,096	1	1,668	6	--	30	4,312	122	432
Stratix V	Buffered Burst	4,096	2	2,602	12	--	30	6,718	176	416
Stratix V	Buffered Burst	4,096	4	4,623	24	--	59	11,876	249	392
Stratix V	Burst Quad Output	1,024	1	1,550	6	--	8	4,037	115	455
Stratix V	Burst Quad Output	1,024	2	2,444	12	--	14	6,417	164	433
Stratix V	Burst Quad Output	1,024	4	4,397	24	--	27	11,548	330	416
Stratix V	Burst Quad Output	256	1	1,487	6	--	8	3,868	83	477
Stratix V	Burst Quad Output	256	2	2,387	12	--	14	6,211	164	458
Stratix V	Burst Quad Output	256	4	4,338	24	--	27	11,360	307	409
Stratix V	Burst Quad Output	4,096	1	1,593	6	--	14	4,222	93	448
Stratix V	Burst Quad Output	4,096	2	2,512	12	--	14	6,588	154	470
Stratix V	Burst Quad Output	4,096	4	4,468	24	--	27	11,773	267	403
Stratix V	Burst Single Output	1,024	1	652	2	--	4	1,553	111	500
Stratix V	Burst Single Output	1,024	2	1,011	4	--	8	2,687	149	476
Stratix V	Burst Single Output	256	1	621	2	--	3	1,502	132	500
Stratix V	Burst Single Output	256	2	978	4	--	8	2,555	173	500
Stratix V	Burst Single Output	4,096	1	681	2	--	9	1,589	149	500
Stratix V	Burst Single Output	4,096	2	1,039	4	--	14	2,755	161	476
Stratix V	Streaming	1,024	—	1,896	6	--	20	4,814	144	490

continued...



Device	Parameters			ALM	DSP Blocks	Memory		Registers		f _{MAX} (MHz)
	Type	Length	Engines			M10K	M20K	Primary	Secondary	
Stratix V	Streaming	256	—	1,604	6	--	20	4,062	99	449
Stratix V	Streaming	4,096	—	1,866	6	--	38	4,889	118	461
Stratix V	Variable Streaming Floating Point	1,024	—	11,607	32	--	87	19,031	974	355
Stratix V	Variable Streaming Floating Point	256	—	8,850	24	--	59	15,297	820	374
Stratix V	Variable Streaming Floating Point	4,096	—	14,335	40	--	115	22,839	1,047	325
Stratix V	Variable Streaming	1,024	—	2,334	14	--	13	5,623	201	382
Stratix V	Variable Streaming	256	—	1,801	10	--	8	4,443	174	365
Stratix V	Variable Streaming	4,096	—	2,924	18	--	23	6,818	238	355

2. FFT IP Core Getting Started

2.1. Installing and Licensing Intel FPGA IP Cores

The Intel Quartus® Prime software installation includes the Intel FPGA IP library. This library provides many useful IP cores for your production use without the need for an additional license. Some Intel FPGA IP cores require purchase of a separate license for production use. The Intel FPGA IP Evaluation Mode allows you to evaluate these licensed Intel FPGA IP cores in simulation and hardware, before deciding to purchase a full production IP core license. You only need to purchase a full production license for licensed Intel IP cores after you complete hardware testing and are ready to use the IP in production.

The Intel Quartus Prime software installs IP cores in the following locations by default:

Figure 1. IP Core Installation Path

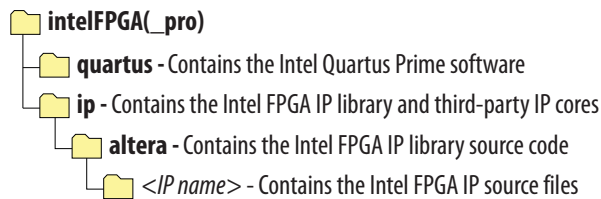

Table 4. IP Core Installation Locations

Location	Software	Platform
<drive>:\intelFPGA_pro\quartus\ip\altera	Intel Quartus Prime Pro Edition	Windows*
<drive>:\intelFPGA\quartus\ip\altera	Intel Quartus Prime Standard Edition	Windows
<home directory>:/intelFPGA_pro/quartus/ip/altera	Intel Quartus Prime Pro Edition	Linux*
<home directory>:/intelFPGA/quartus/ip/altera	Intel Quartus Prime Standard Edition	Linux

Note: The Intel Quartus Prime software does not support spaces in the installation path.

2.1.1. Intel FPGA IP Evaluation Mode

The free Intel FPGA IP Evaluation Mode allows you to evaluate licensed Intel FPGA IP cores in simulation and hardware before purchase. Intel FPGA IP Evaluation Mode supports the following evaluations without additional license:



- Simulate the behavior of a licensed Intel FPGA IP core in your system.
- Verify the functionality, size, and speed of the IP core quickly and easily.
- Generate time-limited device programming files for designs that include IP cores.
- Program a device with your IP core and verify your design in hardware.

Intel FPGA IP Evaluation Mode supports the following operation modes:

- **Tethered**—Allows running the design containing the licensed Intel FPGA IP indefinitely with a connection between your board and the host computer. Tethered mode requires a serial joint test action group (JTAG) cable connected between the JTAG port on your board and the host computer, which is running the Intel Quartus Prime Programmer for the duration of the hardware evaluation period. The Programmer only requires a minimum installation of the Intel Quartus Prime software, and requires no Intel Quartus Prime license. The host computer controls the evaluation time by sending a periodic signal to the device via the JTAG port. If all licensed IP cores in the design support tethered mode, the evaluation time runs until any IP core evaluation expires. If all of the IP cores support unlimited evaluation time, the device does not time-out.
- **Untethered**—Allows running the design containing the licensed IP for a limited time. The IP core reverts to untethered mode if the device disconnects from the host computer running the Intel Quartus Prime software. The IP core also reverts to untethered mode if any other licensed IP core in the design does not support tethered mode.

When the evaluation time expires for any licensed Intel FPGA IP in the design, the design stops functioning. All IP cores that use the Intel FPGA IP Evaluation Mode time out simultaneously when any IP core in the design times out. When the evaluation time expires, you must reprogram the FPGA device before continuing hardware verification. To extend use of the IP core for production, purchase a full production license for the IP core.

You must purchase the license and generate a full production license key before you can generate an unrestricted device programming file. During Intel FPGA IP Evaluation Mode, the Compiler only generates a time-limited device programming file (`<project name>_time_limited.sof`) that expires at the time limit.



Figure 2. Intel FPGA IP Evaluation Mode Flow

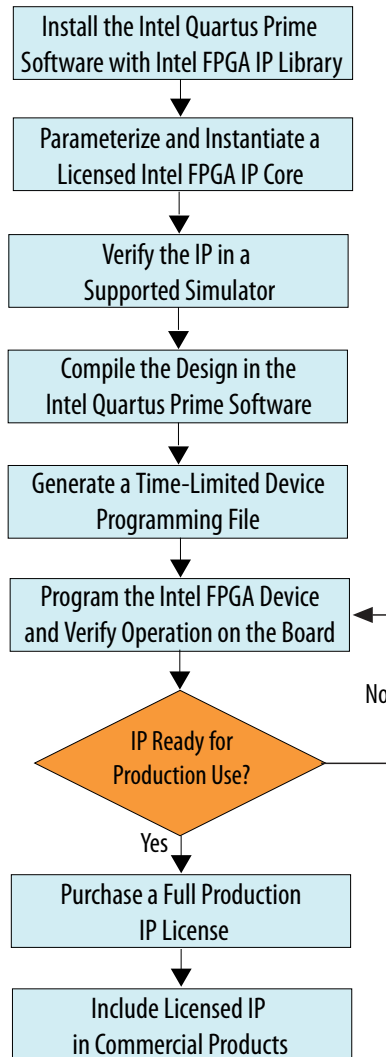

Note: Refer to each IP core's user guide for parameterization steps and implementation details.

Intel licenses IP cores on a per-seat, perpetual basis. The license fee includes first-year maintenance and support. You must renew the maintenance contract to receive updates, bug fixes, and technical support beyond the first year. You must purchase a full production license for Intel FPGA IP cores that require a production license, before generating programming files that you may use for an unlimited time. During Intel FPGA IP Evaluation Mode, the Compiler only generates a time-limited device programming file (*<project name>_time_limited.sof*) that expires at the time limit. To obtain your production license keys, visit the [Self-Service Licensing Center](#).

The [Intel FPGA Software License Agreements](#) govern the installation and use of licensed IP cores, the Intel Quartus Prime design software, and all unlicensed IP cores.



Related Information

- [Intel Quartus Prime Licensing Site](#)
- [Introduction to Intel FPGA Software Installation and Licensing](#)

2.1.2. FFT IP Core Intel FPGA IP Evaluation Mode Timeout Behavior

All IP cores in a device time out simultaneously when the most restrictive evaluation time is reached. If a design has more than one IP core, the time-out behavior of the other IP cores may mask the time-out behavior of a specific IP core .

For IP cores, the untethered time-out is 1 hour; the tethered time-out value is indefinite. Your design stops working after the hardware evaluation time expires. The Quartus Prime software uses Intel FPGA IP Evaluation Mode Files (.ocp) in your project directory to identify your use of the Intel FPGA IP Evaluation Mode evaluation program. After you activate the feature, do not delete these files..

When the evaluation time expires, the `source_real`, `source_imag`, and `source_exp` signals go low.

Related Information

[AN 320: OpenCore Plus Evaluation of Megafunctions](#)

2.2. IP Catalog and Parameter Editor

The IP Catalog displays the IP cores available for your project, including Intel FPGA IP and other IP that you add to the IP Catalog search path.. Use the following features of the IP Catalog to locate and customize an IP core:

- Filter IP Catalog to **Show IP for active device family** or **Show IP for all device families**. If you have no project open, select the **Device Family** in IP Catalog.
- Type in the Search field to locate any full or partial IP core name in IP Catalog.
- Right-click an IP core name in IP Catalog to display details about supported devices, to open the IP core's installation folder, and for links to IP documentation.
- Click **Search for Partner IP** to access partner IP information on the web.

The parameter editor prompts you to specify an IP variation name, optional ports, and output file generation options. The parameter editor generates a top-level Intel Quartus Prime IP file (.ip) for an IP variation in Intel Quartus Prime Pro Edition projects.

The parameter editor generates a top-level Quartus IP file (.qip) for an IP variation in Intel Quartus Prime Standard Edition projects. These files represent the IP variation in the project, and store parameterization information.



Figure 3. IP Parameter Editor (Intel Quartus Prime Standard Edition)

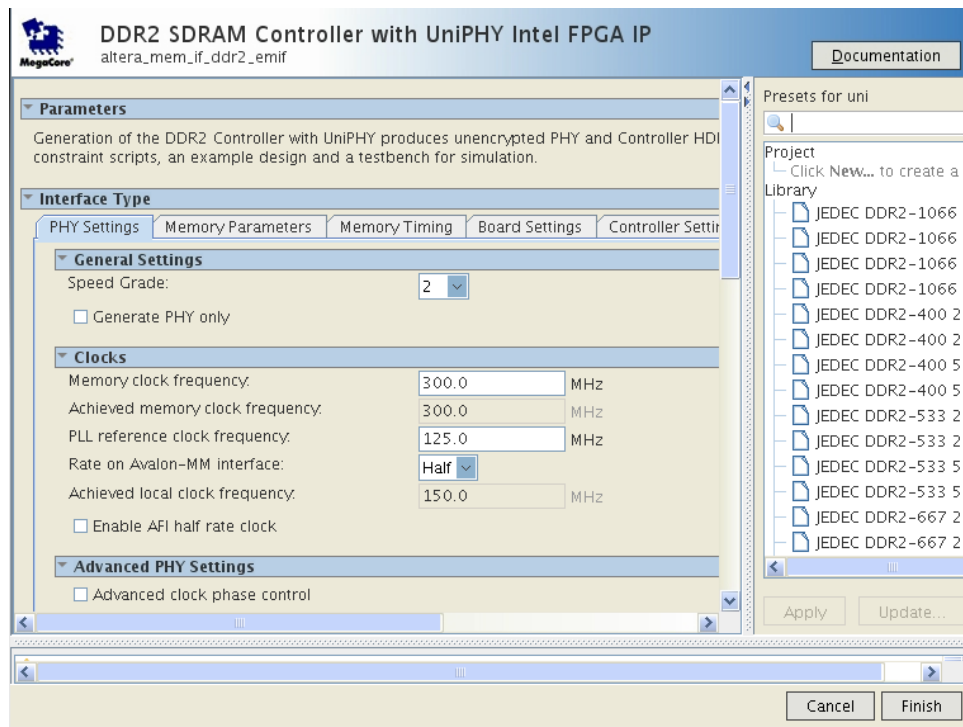

2.3. Generating IP Cores (Intel Quartus Prime Pro Edition)

Quickly configure Intel FPGA IP cores in the Intel Quartus Prime parameter editor. Double-click any component in the IP Catalog to launch the parameter editor. The parameter editor allows you to define a custom variation of the IP core. The parameter editor generates the IP variation synthesis and optional simulation files, and adds the .ip file representing the variation to your project automatically.

Follow these steps to locate, instantiate, and customize an IP core in the parameter editor:

1. Create or open an Intel Quartus Prime project (.qpf) to contain the instantiated IP variation.
2. In the IP Catalog (**Tools** > **IP Catalog**), locate and double-click the name of the IP core to customize. To locate a specific component, type some or all of the component's name in the IP Catalog search box. The New IP Variation window appears.
3. Specify a top-level name for your custom IP variation. Do not include spaces in IP variation names or paths. The parameter editor saves the IP variation settings in a file named <your_ip>.ip. Click **OK**. The parameter editor appears.

Figure 4. IP Parameter Editor (Intel Quartus Prime Pro Edition)

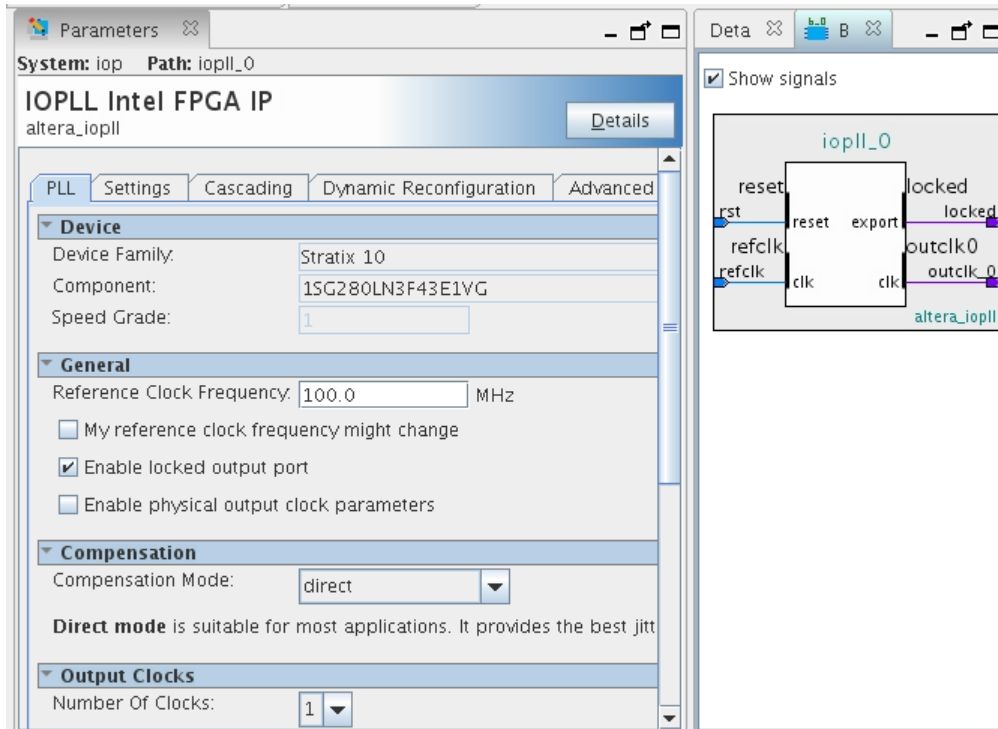

4. Set the parameter values in the parameter editor and view the block diagram for the component. The **Parameterization Messages** tab at the bottom displays any errors in IP parameters:
 - Optionally, select preset parameter values if provided for your IP core. Presets specify initial parameter values for specific applications.
 - Specify parameters defining the IP core functionality, port configurations, and device-specific features.
 - Specify options for processing the IP core files in other EDA tools.

Note: Refer to your IP core user guide for information about specific IP core parameters.
5. Click **Generate HDL**. The **Generation** dialog box appears.
6. Specify output file generation options, and then click **Generate**. The synthesis and simulation files generate according to your specifications.
7. To generate a simulation testbench, click **Generate > Generate Testbench System**. Specify testbench generation options, and then click **Generate**.
8. To generate an HDL instantiation template that you can copy and paste into your text editor, click **Generate > Show Instantiation Template**.
9. Click **Finish**. Click **Yes** if prompted to add files representing the IP variation to your project.
10. After generating and instantiating your IP variation, make appropriate pin assignments to connect ports.



Note: Some IP cores generate different HDL implementations according to the IP core parameters. The underlying RTL of these IP cores contains a unique hash code that prevents module name collisions between different variations of the IP core. This unique code remains consistent, given the same IP settings and software version during IP generation. This unique code can change if you edit the IP core's parameters or upgrade the IP core version. To avoid dependency on these unique codes in your simulation environment, refer to *Generating a Combined Simulator Setup Script*.

2.3.1. IP Core Generation Output (Intel Quartus Prime Pro Edition)

The Intel Quartus Prime software generates the following output file structure for individual IP cores that are not part of a Platform Designer system.

Figure 5. Individual IP Core Generation Output (Intel Quartus Prime Pro Edition)

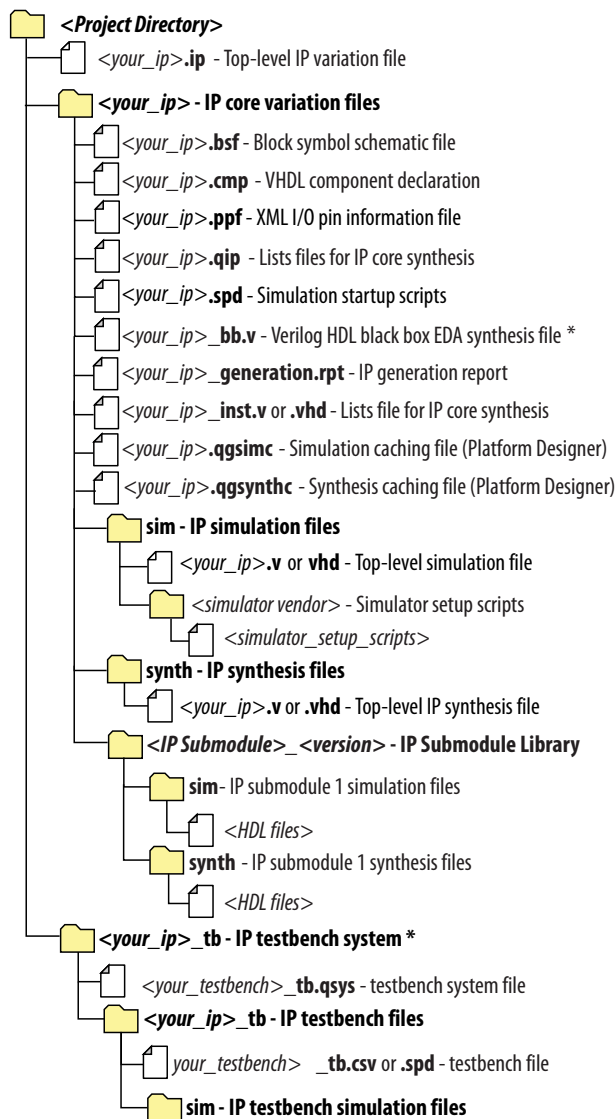

* If supported and enabled for your IP core variation.



Table 5. Output Files of Intel FPGA IP Generation

File Name	Description
<your_ip>.ip	Top-level IP variation file that contains the parameterization of an IP core in your project. If the IP variation is part of a Platform Designer system, the parameter editor also generates a .qsys file.
<your_ip>.cmp	The VHDL Component Declaration (.cmp) file is a text file that contains local generic and port definitions that you use in VHDL design files.
<your_ip>.generation.rpt	IP or Platform Designer generation log file. Displays a summary of the messages during IP generation.
<your_ip>.qgsimc (Platform Designer systems only)	Simulation caching file that compares the .qsys and .ip files with the current parameterization of the Platform Designer system and IP core. This comparison determines if Platform Designer can skip regeneration of the HDL.
<your_ip>.qgsynth (Platform Designer systems only)	Synthesis caching file that compares the .qsys and .ip files with the current parameterization of the Platform Designer system and IP core. This comparison determines if Platform Designer can skip regeneration of the HDL.
<your_ip>.qip	Contains all information to integrate and compile the IP component.
<your_ip>.csv	Contains information about the upgrade status of the IP component.
<your_ip>.bsf	A symbol representation of the IP variation for use in Block Diagram Files (.bdf).
<your_ip>.spd	Input file that ip-make-simscript requires to generate simulation scripts. The .spd file contains a list of files you generate for simulation, along with information about memories that you initialize.
<your_ip>.ppf	The Pin Planner File (.ppf) stores the port and node assignments for IP components you create for use with the Pin Planner.
<your_ip>_bb.v	Use the Verilog blackbox (_bb.v) file as an empty module declaration for use as a blackbox.
<your_ip>_inst.v or _inst.vhd	HDL example instantiation template. Copy and paste the contents of this file into your HDL file to instantiate the IP variation.
<your_ip>.regmap	If the IP contains register information, the Intel Quartus Prime software generates the .regmap file. The .regmap file describes the register map information of master and slave interfaces. This file complements the .sopcinfo file by providing more detailed register information about the system. This file enables register display views and user customizable statistics in System Console.
<your_ip>.svd	Allows HPS System Debug tools to view the register maps of peripherals that connect to HPS within a Platform Designer system. During synthesis, the Intel Quartus Prime software stores the .svd files for slave interface visible to the System Console masters in the .sof file in the debug session. System Console reads this section, which Platform Designer queries for register map information. For system slaves, Platform Designer accesses the registers by name.
<your_ip>.v <your_ip>.vhd	HDL files that instantiate each submodule or child IP core for synthesis or simulation.
mentor/	Contains a msim_setup.tcl script to set up and run a simulation.
aldec/	Contains a script rivierapro_setup.tcl to setup and run a simulation.
/synopsys/vcs /synopsys/vcsmx	Contains a shell script vcs_setup.sh to set up and run a simulation. Contains a shell script vcsmx_setup.sh and synopsys_sim.setup file to set up and run a simulation.

continued...



File Name	Description
/cadence	Contains a shell script <code>ncsim_setup.sh</code> and other setup files to set up and run an simulation.
/xcelium	Contains an Parallel simulator shell script <code>xcelium_setup.sh</code> and other setup files to set up and run a simulation.
/submodules	Contains HDL files for the IP core submodule.
<IP submodule>/	Platform Designer generates <code>/synth</code> and <code>/sim</code> sub-directories for each IP submodule directory that Platform Designer generates.

2.4. Generating IP Cores (Intel Quartus Prime Standard Edition)

This topic describes parameterizing and generating an IP variation using a legacy parameter editor in the Intel Quartus Prime Standard Edition software.

Figure 6. Legacy Parameter Editors

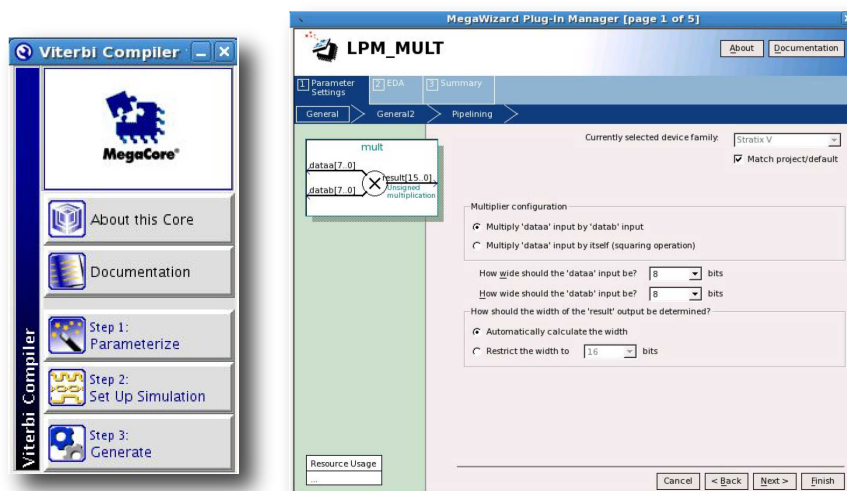

Note: The legacy parameter editor generates a different output file structure than the Intel Quartus Prime Pro Edition software.

1. In the IP Catalog (**Tools** > **IP Catalog**), locate and double-click the name of the IP core to customize. The parameter editor appears.
2. Specify a top-level name and output HDL file type for your IP variation. This name identifies the IP core variation files in your project. Click **OK**. Do not include spaces in IP variation names or paths.
3. Specify the parameters and options for your IP variation in the parameter editor. Refer to your IP core user guide for information about specific IP core parameters.
4. Click **Finish** or **Generate** (depending on the parameter editor version). The parameter editor generates the files for your IP variation according to your specifications. Click **Exit** if prompted when generation is complete. The parameter editor adds the top-level `.qip` file to the current project automatically.



Note: For devices released prior to Intel Arria 10 devices, the generated .qip and .sip files must be added to your project to represent IP and Platform Designer systems. To manually add an IP variation generated with legacy parameter editor to a project, click **Project > Add/Remove Files in Project** and add the IP variation .qip file.

2.4.1. IP Core Generation Output (Intel Quartus Prime Standard Edition)

The Intel Quartus Prime Standard Edition software generates one of the following output file structures for individual IP cores that use one of the legacy parameter editors.



Figure 7. IP Core Generated Files (Legacy Parameter Editors)

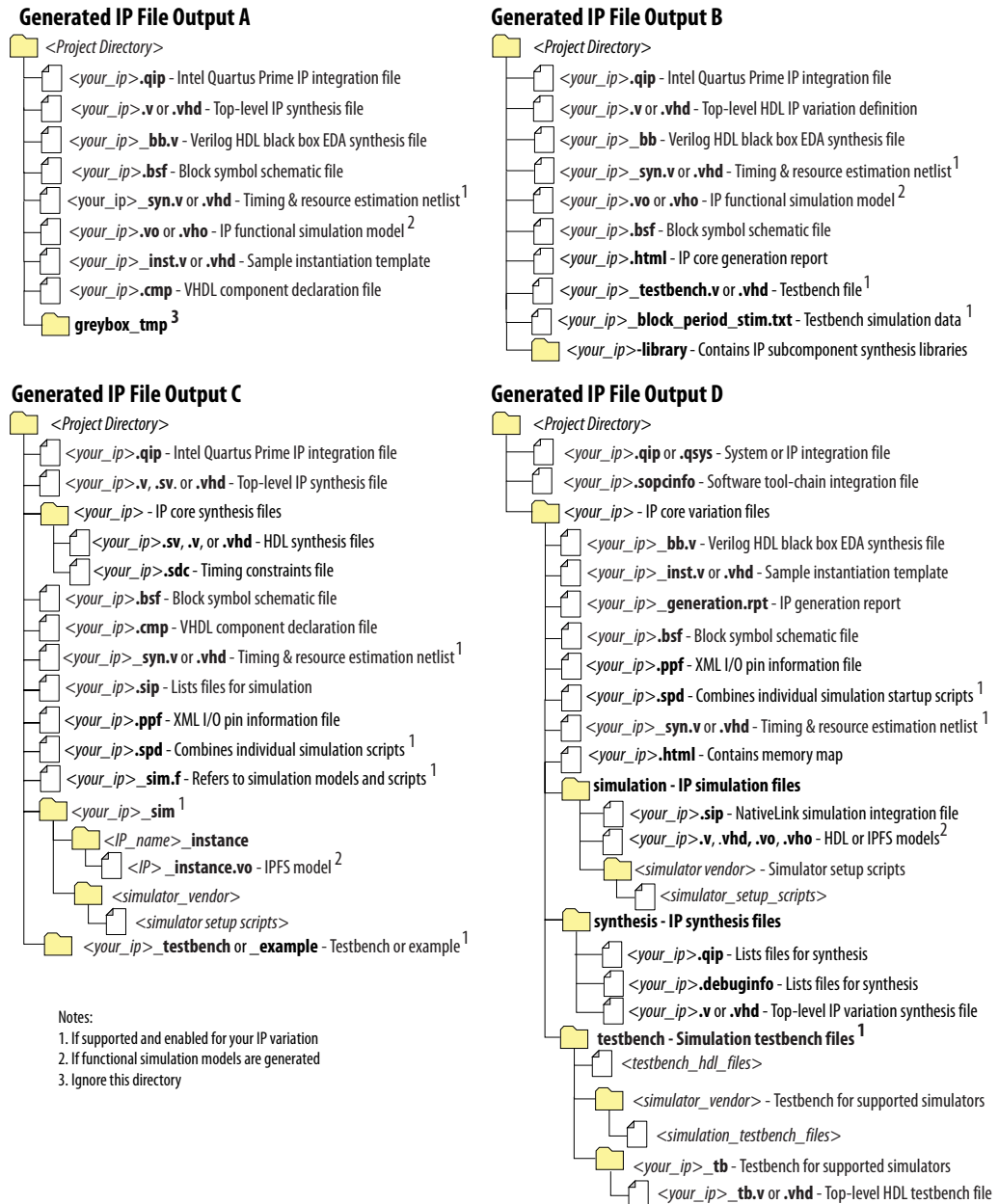

- Notes:
1. If supported and enabled for your IP variation
 2. If functional simulation models are generated
 3. Ignore this directory

2.5. Simulating Intel FPGA IP Cores

The Intel Quartus Prime software supports IP core RTL simulation in specific EDA simulators. IP generation creates simulation files, including the functional simulation model, any testbench (or example design), and vendor-specific simulator setup scripts for each IP core. Use the functional simulation model and any testbench or example design for simulation. IP generation output may also include scripts to compile and run any testbench. The scripts list all models or libraries you require to simulate your IP core.

The Intel Quartus Prime software provides integration with many simulators and supports multiple simulation flows, including your own scripted and custom simulation flows. Whichever flow you choose, IP core simulation involves the following steps:

1. Generate simulation model, testbench (or example design), and simulator setup script files.
2. Set up your simulator environment and any simulation scripts.
3. Compile simulation model libraries.
4. Run your simulator.

2.5.1. Simulating the Fixed-Transform FFT IP Core in the MATLAB Software

The FFT IP Core produces a bit-accurate MATLAB model `<variation name>_model.m`, which you can use to model the behavior of your custom FFT variation in the MATLAB software.

The model takes a complex vector as input and it outputs the transform-domain complex vector and corresponding block exponent values. The length and direction of the transform (FFT/IFFT) are also passed as inputs to the model. If the input vector length is an integral multiple of N , the transform length, the length of the output vector(s) is equal to the length of the input vector. However, if the input vector is not an integral multiple of N , it is zero-padded to extend the length to be so. The wizard also creates the MATLAB testbench file `<variation name>_tb.m`. This file creates the stimuli for the MATLAB model by reading the input complex random data from generated files. If you selected **Floating point** data representation, the IP core generates the input data in hexadecimal format.

1. Run the MATLAB software.
2. Simulate the design:
 - a. Type `help <variation name>_model` at the command prompt to view the input and output vectors that are required to run the MATLAB model as a standalone M-function. Create your input vector and make a function call to `<variation name>_model`. For example:

```
N=2048;
INVERSE = 0;
% 0 => FFT 1=> IFFT x = (2^12)*rand(1,N) + j*(2^12)*rand(1,N);
[y,e] = <variation name>_model(x,N,INVERSE);
```

- b. Alternatively, run the provided testbench by typing the name of the testbench, `<variation name>_tb` at the command prompt.

2.5.2. Simulating the Variable Streaming FFT IP Core in the MATLAB Software

The FFT IP Core produces a bit-accurate MATLAB model `<variation name>_model.m`, which you can use to model the behavior of your custom FFT variation in the MATLAB software.

The model takes a complex vector as input and it outputs the transform-domain complex vector. The lengths and direction of the transforms (FFT/IFFT) (specified as one entry per block) are also passed as an input to the model. You must ensure that the length of the input vector is at least as large as the sum of the transform sizes for



the model to function correctly. The wizard also creates the MATLAB testbench file `<variation name>_tb.m`. This file creates the stimuli for the MATLAB model by reading the input complex random data from the generated files.

1. Run the MATLAB software.
2. In the MATLAB command window, change to the working directory for your project.
3. Simulate the design:
 - a. Type `help <variation name>_model` at the command prompt to view the input and output vectors that are required to run the MATLAB model as a standalone M-function. Create your input vector and make a function call to `<variation name>_model`. For example:

```
nps=[256,2048];  
inverse = [0,1]; % 0 => FFT 1=> IFFT  
x = (2^12)*rand(1,sum(nps)) + j*(2^12)*rand(1,sum(nps));  
[y] = <variation name>_model(x,nps,inverse);
```

- b. Alternatively, run the provided testbench by typing the name of the testbench, `<variation name>_tb` at the command prompt.

Note: If you select digit-reversed output order, you can reorder the data with the following MATLAB code:

```
y = y(digit_reverse(0:(FFTSIZE-1), log2(FFTSIZE)) + 1);
```

where `digit_reverse` is:

```
function y = digit_reverse(x, n_bits)  
if mod(n_bits,2)  
    z = dec2bin(x, n_bits);  
    for i=1:2:n_bits-1  
        p(:,i) = z(:,n_bits-i);  
        p(:,i+1) = z(:,n_bits-i+1);  
    end  
    p(:,n_bits) = z(:,1);  
    y=bin2dec(p);  
else  
    y=digitrevorder(x,4);  
end
```

2.6. DSP Builder for Intel FPGAs Design Flow

DSP Builder for Intel FPGAs shortens digital signal processing (DSP) design cycles by helping you create the hardware representation of a DSP design in an algorithm-friendly development environment.

This IP core supports DSP Builder for Intel FPGAs. Use the DSP Builder for Intel FPGAs flow if you want to create a DSP Builder for Intel FPGAs model that includes an IP core variation; use IP Catalog if you want to create an IP core variation that you can instantiate manually in your design.

Related Information

[Using MegaCore Functions chapter in the DSP Builder for Intel FPGAs Handbook.](#)

3. FFT IP Core Functional Description

3.1. Fixed Transform FFTs

The buffered, burst, and streaming FFTs use a radix-4 decomposition, which divides the input sequence recursively to form four-point sequences, requires only trivial multiplications in the four-point DFT. Radix-4 gives the highest throughput decomposition, while requiring non-trivial complex multiplications in the post-butterfly twiddle-factor rotations only. In cases where N is an odd power of two, the FFT MegaCore automatically implements a radix-2 pass on the last pass to complete the transform.

To maintain a high signal-to-noise ratio throughout the transform computation, the fixed transform FFTs use a block-floating-point architecture, which is a trade-off point between fixed-point and full-floating-point architectures.

3.2. Variable Streaming FFTs

The variable streaming FFTs use fixed-point data representation or the floating point representation.

If you select the fixed-point data representation, the FFT variation uses a radix 2^2 single delay feedback, which is fully pipelined. If you select the floating point representation, the FFT variation uses a mixed radix-4/2. For a length N transform, $\log_4(N)$ stages are concatenated together. The radix 2^2 algorithm has the same multiplicative complexity of a fully pipelined radix-4 FFT, but the butterfly unit retains a radix-2 FFT. The radix-4/2 algorithm combines radix-4 and radix-2 FFTs to achieve the computational advantage of the radix-4 algorithm while supporting FFT computation with a wider range of transform lengths. The butterfly units use the DIF decomposition.

Fixed point representation allows for natural word growth through the pipeline. The maximum growth of each stage is 2 bits. After the complex multiplication the data is rounded down to the expanded data size using convergent rounding. The overall bit growth is less than or equal to $\log_2(N)+1$.

The floating point internal data representation is single-precision floating-point (32-bit, IEEE 754 representation). Floating-point operations provide more precise computation results but are costly in hardware resources. To reduce the amount of logic required for floating point operations, the variable streaming FFT uses fused floating point kernels. The reduction in logic occurs by fusing together several floating point operations and reducing the number of normalizations that need to occur.



3.2.1. Fixed-Point Variable Streaming FFTs

Fixed point variable streaming FFTs implements a radix- 2^2 single delay feedback. It is similar to radix-2 single delay feedback. However, the twiddle factors are rearranged such that the multiplicative complexity is equivalent to a radix-4 single delay feedback.

$\log_2(N)$ stages each containing a single butterfly unit and a feedback delay unit that delays the incoming data by a specified number of cycles, halved at every stage. These delays effectively align the correct samples at the input of the butterfly unit for the butterfly calculations. Every second stage contains a modified radix-2 butterfly whereby a trivial multiplication by j is performed before the radix-2 butterfly operations.

The following scheduled operations occur in the pipeline for an FFT of length $N = 16$.

1. For the first 8 clock cycles, the samples are fed unmodified through the butterfly unit to the delay feedback unit.
2. The next 8 clock cycles perform the butterfly calculation using the data from the delay feedback unit and the incoming data. The higher order calculations are sent through to the delay feedback unit while the lower order calculations are sent to the next stage.
3. The next 8 clock cycles feed the higher order calculations stored in the delay feedback unit unmodified through the butterfly unit to the next stage.

Subsequent data stages use the same principles. However, the delays in the feedback path are adjusted accordingly.

3.2.2. Floating-Point Variable Streaming FFTs

Floating-point variable streaming FFTs implement a mixed radix-4/2, which combines the advantages of using radix-2 and radix-4 butterflies.

The FFT has $\text{ceiling}(\log_4(N))$ stages. If transform length is an integral power of four, a radix-4 FFT implements all of the $\log_4(N)$ stages. If transform length is not an integral power of four, the FFT implements $\text{ceiling}(\log_4(N)) - 1$ of the stages in a radix-4, and implements the remaining stage using a radix-2.

Each stage contains a single butterfly unit and a feedback delay unit. The feedback delay unit delays the incoming data by a specified number of cycles; in each stage the number of cycles of delay is one quarter of the number of cycles of delay in the previous stage. The delays align the butterfly input samples correctly for the butterfly calculations. The output of the pipeline is in index-reversed order.

3.3. FFT Processor Engines

You can parameterize the FFT MegaCore function to use either quad-output or single-output engines. To increase the overall throughput of the FFT MegaCore function, you may also use multiple parallel engines of a variation.

3.3.1. Quad-Output FFT Engine

To minimize transform time, use a quad-output FFT engine. Quad-output refers to the throughput of the internal FFT butterfly processor. The engine implementation computes all four radix-4 butterfly complex outputs in a single clock cycle.

Figure 8. Quad-Output FFT Engine

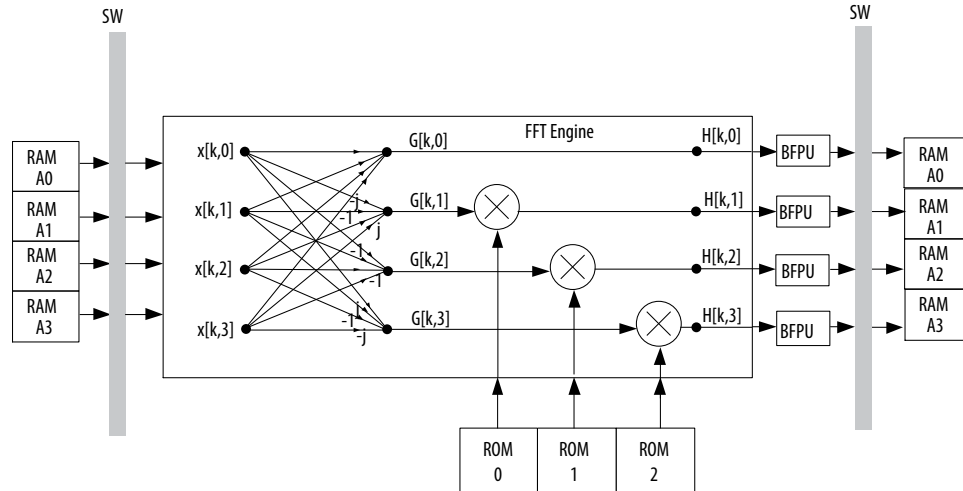

The FFT reads complex data samples $x[k,m]$ from internal memory in parallel and reorders by switch (SW). Next, the radix-4 butterfly processor processes the ordered samples to form the complex outputs $G[k,m]$. Because of the inherent mathematics of the radix-4 DIF decomposition, only three complex multipliers perform the three non-trivial twiddle-factor multiplications on the outputs of the butterfly processor. To discern the maximum dynamic range of the samples, the block-floating point units (BFPU) evaluate the four outputs in parallel. The FFT discards the appropriate LSBs and rounds and reorders the complex values before writing them back to internal memory.

3.3.2. Single-Output FFT Engine

For the minimum-size FFT function, use a single-output engine. The term single-output refers to the throughput of the internal FFT butterfly processor. In the engine, the FFT calculates a single butterfly output per clock cycle, requiring a single complex multiplier.

Figure 9. Single-Output FFT Engine

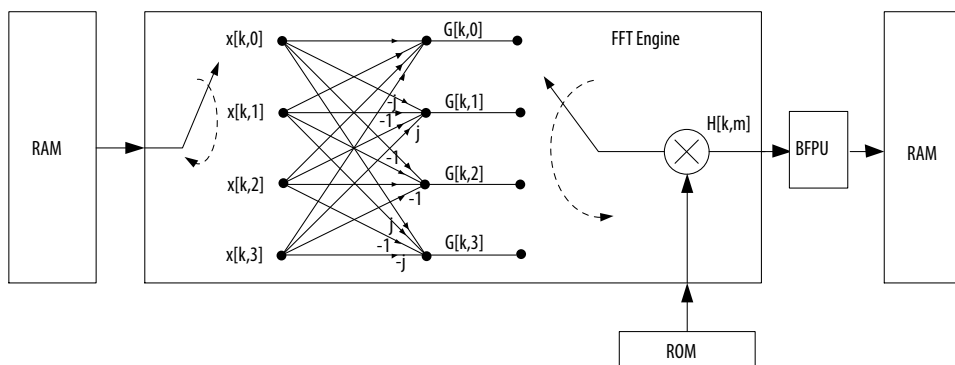

3.4. I/O Data Flow

3.4.1. Streaming FFT

The streaming FFT allows continuous processing of input data, and outputs a continuous complex data stream without the need to halt the data flow in or out of the FFT IP core.

The streaming FFT generates a design with a quad output FFT engine and the minimum number of parallel FFT engines for the required throughput.

A single FFT engine provides enough performance for up to a 1,024-point streaming I/O data flow FFT.

3.4.1.1. Using the Streaming FFT

When the data transfer is complete, the FFT deasserts `sink_sop` and loads the data samples in natural order.

Figure 10. FFT Streaming Data Flow Simulation Waveform

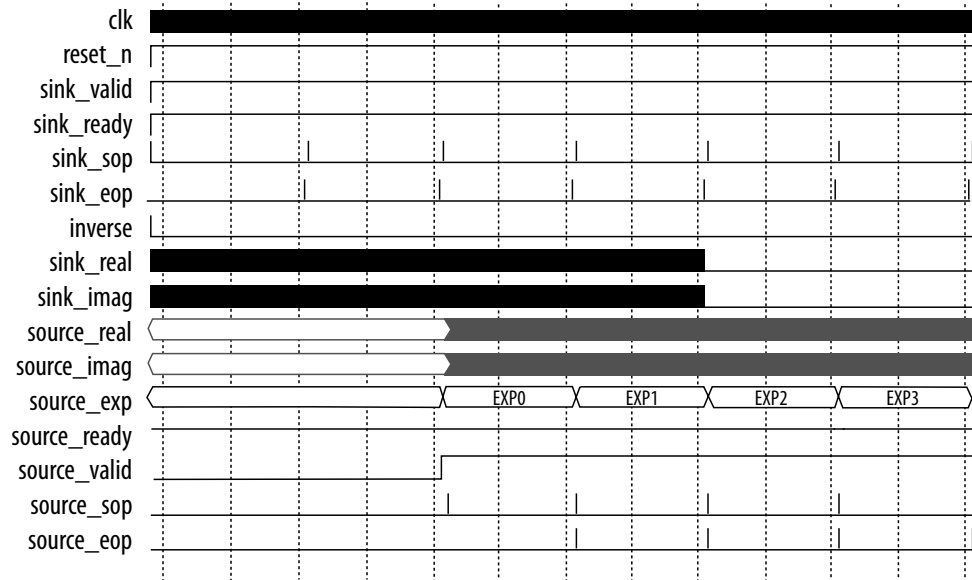

When the final sample loads, the source asserts `sink_eop` and `sink_valid` for the last data transfer.

Figure 11. FFT Streaming Data Flow Input

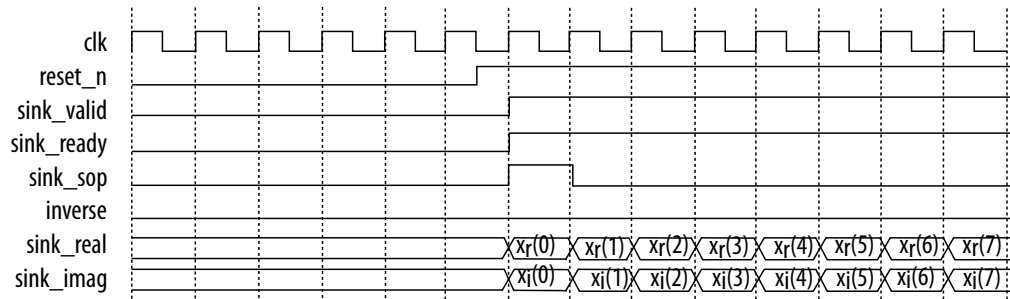

1. Deassert the system reset.

The data source asserts `sink_valid` to indicate to the FFT function that valid data is available for input. Assert both the `sink_valid` and the `sink_ready` for a successful data transfer.

Related Information

[Avalon Interface Specifications](#)

3.4.1.2. Changing the Direction on a Block-by-Block Basis

1. Assert or deassert `inverse` (appropriately) simultaneously with the application of the `sink_sop` pulse (concurrent with the first input data sample of the block).



When the FFT completes the transform of the input block, it asserts `source_valid` and outputs the complex transform domain data block in natural order. The FFT function asserts `source_sop` to indicate the first output sample.

Figure 12. FFT Streaming Data Flow Output Flow Control

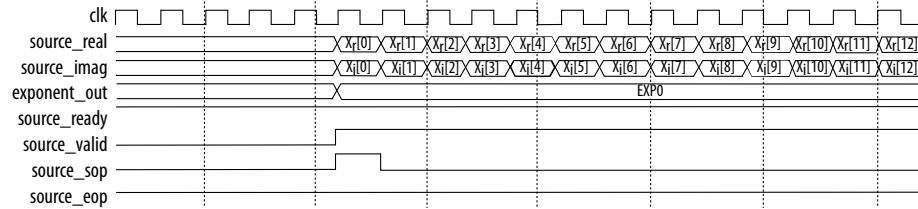

After N data transfers, the FFT asserts `source_eop` to indicate the end of the output data block

3.4.1.3. Enabling the Streaming FFT

1. You must assert the `sink_valid` signal for the FFT to assert `source_valid` (and a valid data output).
2. To extract the final frames of data from the FFT, you need to provide several frames where the `sink_valid` signal is asserted and apply the `sink_sop` and `sink_eop` signals in accordance with the Avalon-ST specification.

3.4.2. Variable Streaming

The variable streaming FFT allows continuous streaming of input data and produces a continuous stream of output data similar to the streaming FFT. With the variable streaming FFT, the transform length represents the maximum transform length. You can perform all transforms of length 2^m where $6 < m < \log_2(\text{transform length})$ at runtime.

3.4.2.1. Changing Block Size

1. To change the size of the FFT on a block-by-block basis, change the value of the `fftpnts` simultaneously with the application of the `sink_sop` pulse (concurrent with the first input data sample of the block).

Table 6. fftpnts and Transform Size

The value of the `fftpnts` signal and the equivalent transform size.

<code>fftpnts</code>	Transform Size
10000000000	1,024
01000000000	512
00100000000	256
00010000000	128
00001000000	64

`fftpnts` uses a binary representation of the size of the transform, therefore for a block with maximum transfer size of 1,024.

Always drive `fftpts_in` even if you are not dynamically changing the block size. For a fixed implementation drive it to match the transform length in the parameter editor.

3.4.2.2. Changing Direction

To change direction on a block-by-block basis:

1. Assert or deassert `inverse` (appropriately) simultaneously with the application of the `sink_sop` pulse (concurrent with the first input data sample of the block).

When the FFT completes the transform of the input block, it asserts `source_valid` and outputs the complex transform domain data block. The FFT function asserts the `source_sop` to indicate the first output sample. The order of the output data depends on the output order that you select in IP Toolbench. The output of the FFT may be in natural order order.

3.4.2.3. I/O Order

The input order allows you to select the order in which you feed the samples to the FFT.

Table 7. Input Order

Order	Description
Natural order	The FFT requires the order of the input samples to be sequential (1, 2 ..., n - 1, n) where n is the size of the current transform.
Digit Reverse Order	The FFT requires the input samples to be in digit-reversed order.
-N/2 to N/2	The FFT requires the input samples to be in the order -N/2 to (N/2) - 1 (also known as DC-centered order)

Similarly the output order specifies the order in which the FFT generates the output. Whether you can select **Bit Reverse Order** or **Digit Reverse Order** depends on your **Data Representation (Fixed Point or Floating Point)**. If you select **Fixed Point**, the FFT variation implements the radix-22 algorithm and the reverse I/O order option is **Bit Reverse Order**. If you select **Floating Point**, the FFT variation implements the mixed radix-4/2 algorithm and the reverse I/O order option is **Digit Reverse Order**.

For sample digit-reversed order, if n is a power of four, the order is radix-4 digit-reversed order, in which two-bit digits in the sample number are units in the reverse ordering. For example, if n = 16, sample number 4 becomes the second sample in the sample stream (by reversal of the digits in 0001, the location in the sample stream, to 0100). However, in mixed radix-4/2 algorithm, n need not be a power of four. If n is not a power of four, the two-bit digits are grouped from the least significant bit, and the most significant bit becomes the least significant bit in the digit-reversed order. For example, if n = 32, the sample number 18 (10010) in the natural ordering becomes sample number 17 (10001) in the digit-reversed order.

3.4.2.4. Enabling the Variable Streaming FFT

1. Assert `sink_valid`.
2. Transfer valid data to the FFT. The FFT processes data.



Example 1. FFT Behavior When sink_valid is Deasserted

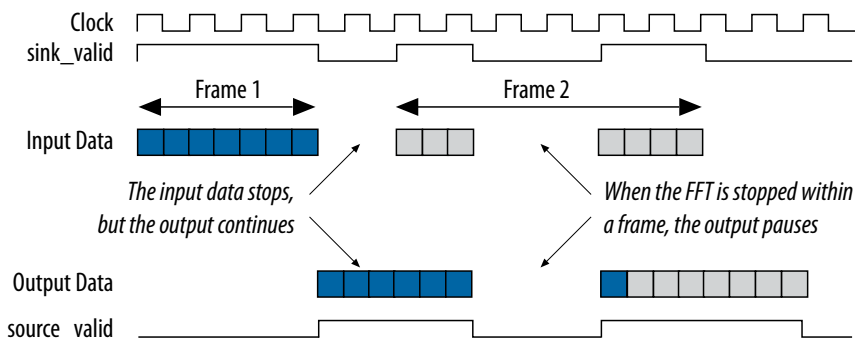

1. Deassert `sink_valid` during a frame to stall the FFT, which then processes no data until you assert `sink_valid`. Any previous frames that are still in the FFT also stall.
2. If you deassert `sink_valid` between frames, the FFT processes and transfers the data currently in the FFT to the output.
3. Disable the FFT by deasserting the `clk_en` signal.

3.4.2.5. Dynamically Changing the FFT Size

The FFT stalls the incoming data (deasserts the `sink_ready` signal) until all the FFT processes and transfers all of the previous FFT frames of the previous FFT size to the output.

Figure 13. Dynamically Changing the FFT Size

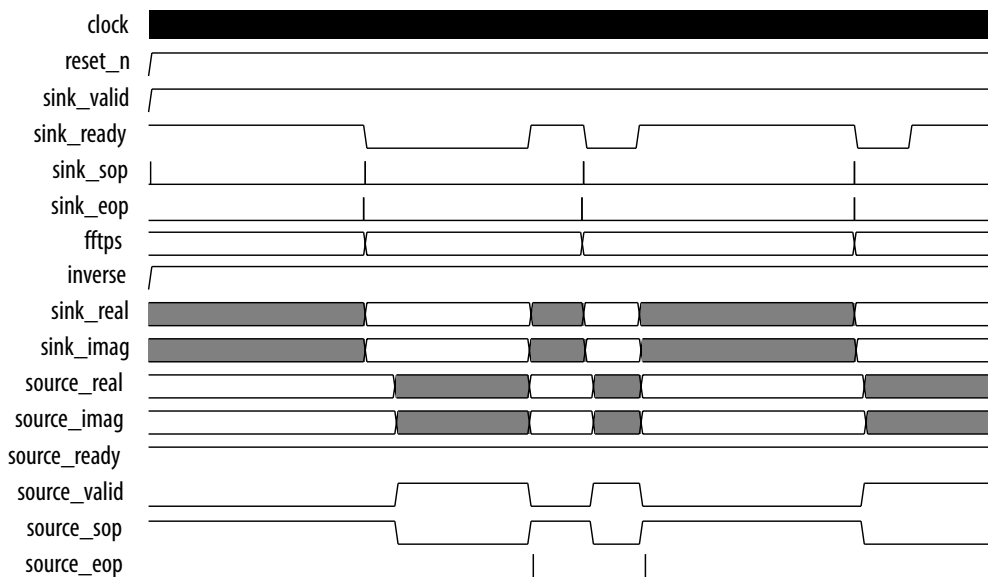

1. Change the size of the incoming FFT,

3.4.2.6. I/O Order

The **I/O order** determines order of samples entering and leaving the FFT and also determines if the FFT is operating in engine-only mode or engine with bit-reversal or digit-reversal mode.

If the FFT operates in engine-only mode, the output data is available after approximately $N + \text{latency}$ clocks cycles after the first sample was input to the FFT. Latency represents a small latency through the FFT core and depends on the transform size. For engine with bit-reversal mode, the output is available after approximately $2N + \text{latency}$ cycles.

Figure 14. Data Flow—Engine-Only Mode

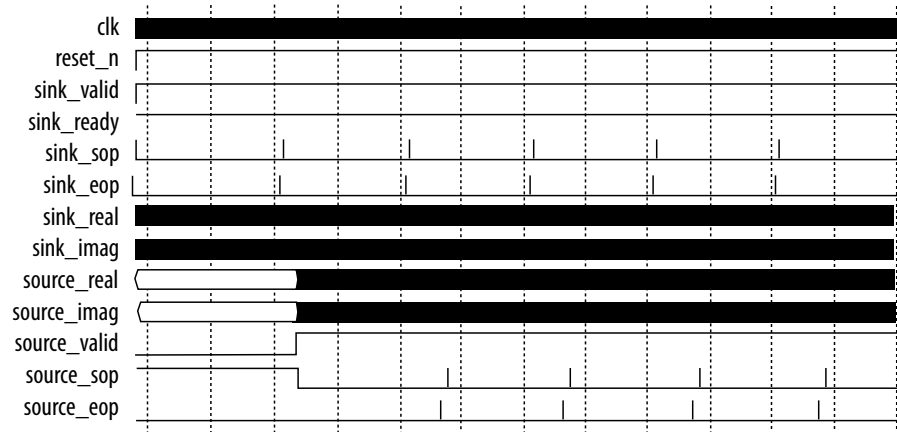
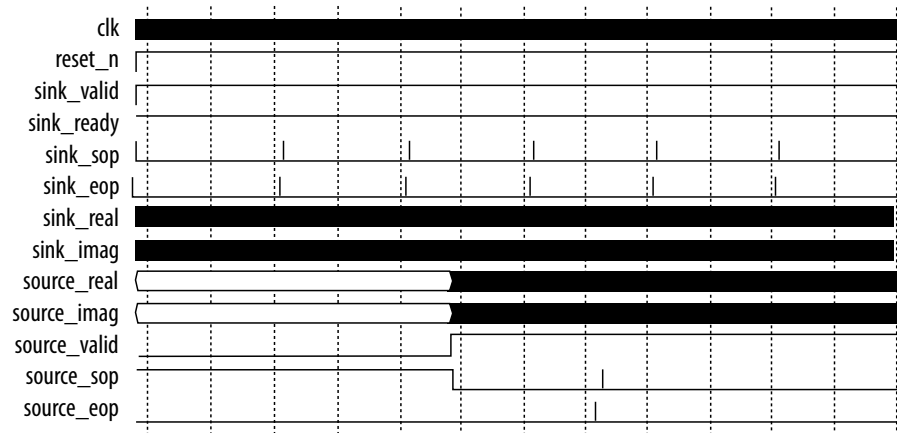

Figure 15. Data Flow—Engine with Bit-Reversal or Digit-Reversal Mode



3.4.3. Buffered Burst

The buffered burst I/O data flow FFT requires fewer memory resources than the streaming I/O data flow FFT, but the tradeoff is an average block throughput reduction.



3.4.3.1. Enabling the Buffered Burst FFT

Figure 16. FFT Buffered Burst Data Flow Input Flow Control

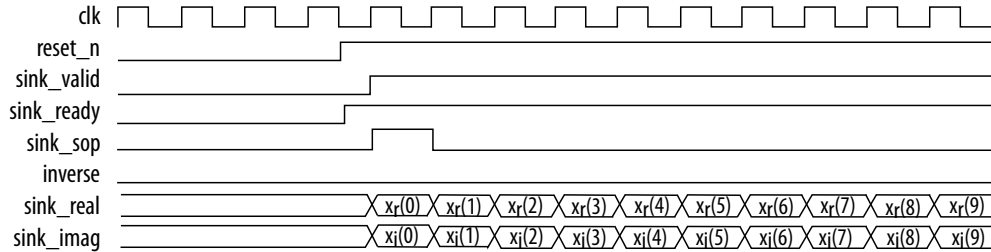

1. Following the interval of time where the FFT processor reads the input samples from an internal input buffer, it re-asserts `sink_ready` indicating it is ready to read in the next input block. Apply a pulse on `sink_sop` aligned in time with the first input sample of the next block to indicate the beginning of the subsequent input block.
2. As in all data flows, the logical level of `inverse` for a particular block is registered by the FFT at the time when you assert the start-of-packet signal, `sink_sop`.

When the FFT completes the transform of the input block, it asserts the `source_valid` and outputs the complex transform domain data block in natural order .

Figure 17. FFT Buffered Burst Data Flow Output Flow Control

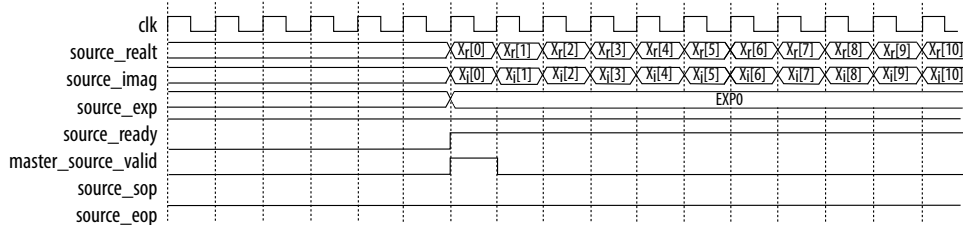

Signals `source_sop` and `source_eop` indicate the start-of-packet and end-of-packet for the output block data respectively.

Note:

You must assert the `sink_valid` signal for `source_valid` to be asserted (and a valid data output). You must leave `sink_valid` signal asserted at the end of data transfers to extract the final frames of data from the FFT.

1. Deassert the system reset.
2. Asserts `sink_valid` to indicate to the FFT function that valid data is available for input. A successful data transfer occurs when both the `sink_valid` and the `sink_ready` are asserted.
3. Load the first complex data sample into the FFT function and simultaneously asserts `sink_sop` to indicate the start of the input block.

4. On the next clock cycle, `sink_sop` is deasserted and you must load the following $N - 1$ complex input data samples in natural order.
5. On the last complex data sample, assert `sink_eop`.
6. When you load the input block, the FFT function begins computing the transform on the stored input block. Hold the `sink_ready` signal high as you can transfer the first few samples of the subsequent frame into the small FIFO at the input. If this FIFO buffer is filled, the FFT deasserts the `sink_ready` signal. It is not mandatory to transfer samples during `sink_ready` cycles.

Example 2. FFT Buffered Burst Data Flow Simulation Waveform

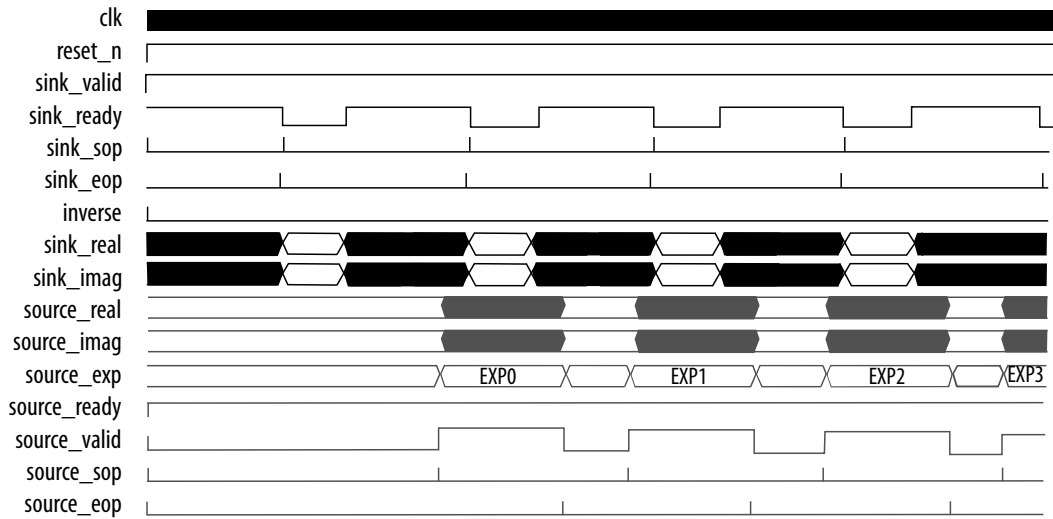

Related Information

[Enabling the Streaming FFT on page 31](#)

3.4.4. Burst

The burst I/O data flow FFT operates similarly to the buffered burst FFT, except that the burst FFT requires even lower memory resources for a given parameterization at the expense of reduced average throughput. The following figure shows the simulation results for the burst FFT. The signals `source_valid` and `sink_ready` indicate, to the system data sources and slave sinks either side of the FFT, when the FFT can accept a new block of data and when a valid output block is available on the FFT output.



Figure 18. FFT Burst Data Flow Simulation Waveform

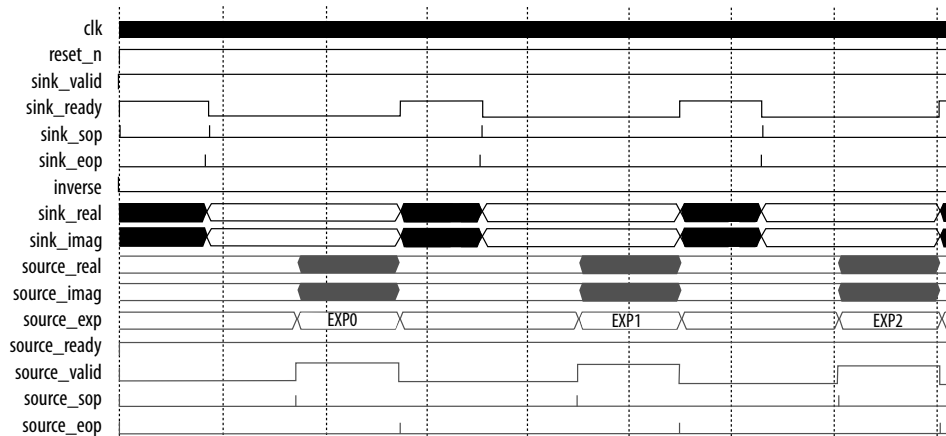

In a burst I/O data flow FFT, the FFT can process a single input block only. A small FIFO buffer at the sink of the block and `sink_ready` is not deasserted until this FIFO buffer is full. You can provide a small number of additional input samples associated with the subsequent input block. You don't have to provide data to the FFT during `sink_ready` cycles. The burst FFT can load the rest of the subsequent FFT frame only when the previous transform is fully unloaded.

Related Information

[Enabling the Streaming FFT on page 31](#)

3.5. FFT IP Core Parameters

Table 8. Basic Parameters

Parameter	Value	Description
Transform Length	64, 128, 256, 512, 1024, 2048, 4096, 8192, 16384, 32768, or 65536. Variable streaming also allows 8, 16, 32, 131072, and 262144.	The transform length. For variable streaming, this value is the maximum FFT length.
Transform Direction	Forward, reverse, bidirectional	The transform direction.
I/O Data Flow	Streaming Variable Streaming Buffered Burst Burst	If you select Variable Streaming and Floating Point, the precision is automatically set to 32, and the reverse I/O order options are Digit Reverse Order.
I/O Order	Bit Reverse Order, Digit Reverse Order, Natural Order, N/2 to N/2	The input and output order for data entering and leaving the FFT (variable streaming FFT only). The Digit Reverse Order option replaces the Bit Reverse Order in variable streaming floating point variations.
Data Representation	Fixed point or single floating point, or block floating point	The internal data representation type (variable streaming FFT only), either fixed point with natural bit-growth or single precision floating point. Floating-point bidirectional IP cores expect input in

continued...



Parameter	Value	Description
		natural order for forward transforms and digit reverse order for reverse transforms. The output order is digit reverse order for forward transforms and natural order for reverse transforms.
Data Width	8, 10, 12, 14, 16, 18, 20, 24, 28, 32	The data precision. The values 28 and 32 are available for variable streaming only.
Twiddle Width	8, 10, 12, 14, 16, 18, 20, 24, 28, 32	The twiddle precision. The values 28 and 32 are available for variable streaming only. Twiddle factor precision must be less than or equal to data precision.

The FFT IP core's advanced parameters.

Table 9. Advanced Parameters

Parameter	Value	Description
FFT Engine Architecture	Quad Output, Single Output	Choose between one, two, and four quad-output FFT engines working in parallel. Alternatively, if you have selected a single-output FFT engine architecture, you may choose to implement one or two engines in parallel. Multiple parallel engines reduce transform time at the expense of device resources, which allows you to select the desired area and throughput trade-off point. Not available for variable streaming or streaming FFTs.
Number of Parallel FFT Engines	1, 2, 4	
DSP Block Resource Optimization	On or Off	Turn on for multiplier structure optimizations. These optimizations use different DSP block configurations to pack multiply operations and reduce DSP resource requirements. This optimization may reduce F_{MAX} because of the structure of the specific configurations of the DSP blocks when compared to the basic operation. Specifically, on Stratix V devices, this optimization may also come at the expense of accuracy. You can evaluate it using the MATLAB model provided and bit wise accurate simulation models. If you turn on DSP Block Resource Optimization and your variation has data precision between 18 and 25 bits, inclusive, and twiddle precision less than or equal to 18 bits, the FFT MegaCore function configures the DSP blocks in complex 18 x 25 multiplication mode.
Enable Hard Floating Point Blocks	On or off	For Arria 10 devices and single-floating-point FFTs only.

3.6. FFT IP Core Interfaces and Signals

The FFT IP core uses the Avalon-ST interface. You may achieve a higher clock rate by driving the source ready signal `source_ready` of the FFT high, and not connecting the sink ready signal `sink_ready`.

The FFT MegaCore function has a `READY_LATENCY` value of zero.

3.6.1. Avalon-ST Interfaces in DSP IP Cores

Avalon-ST interfaces define a standard, flexible, and modular protocol for data transfers from a source interface to a sink interface.

The input interface is an Avalon-ST sink and the output interface is an Avalon-ST source. The Avalon-ST interface supports packet transfers with packets interleaved across multiple channels.



Avalon-ST interface signals can describe traditional streaming interfaces supporting a single stream of data without knowledge of channels or packet boundaries. Such interfaces typically contain data, ready, and valid signals. Avalon-ST interfaces can also support more complex protocols for burst and packet transfers with packets interleaved across multiple channels. The Avalon-ST interface inherently synchronizes multichannel designs, which allows you to achieve efficient, time-multiplexed implementations without having to implement complex control logic.

Avalon-ST interfaces support backpressure, which is a flow control mechanism where a sink can signal to a source to stop sending data. The sink typically uses backpressure to stop the flow of data when its FIFO buffers are full or when it has congestion on its output.

Related Information

[Avalon Interface Specifications](#)

3.6.2. FFT IP Core Avalon-ST Signals

Table 10. Avalon-ST Signals

Signal Name	Direction	Avalon-ST Type	Size	Description
clk	Input	clk	1	Clock signal that clocks all internal FFT engine components.
reset_n	Input	reset_n	1	Active-low asynchronous reset signal. This signal can be asserted asynchronously, but must remain asserted at least one clk clock cycle and must be deasserted synchronously with clk.
sink_eop	Input	endofpacket	1	Indicates the end of the incoming FFT frame.
sink_error	Input	error	2	Indicates an error has occurred in an upstream module, because of an illegal usage of the Avalon-ST protocol. The following errors are defined: <ul style="list-style-type: none"> 00 = no error 01 = missing start of packet (SOP) 10 = missing end of packet (EOP) 11 = unexpected EOP If this signal is not used in upstream modules, set to zero.
sink_imag	Input	data	data precision width	Imaginary input data, which represents a signed number of data precision bits.
sink_ready	Output	ready	1	Asserted by the FFT engine when it can accept data. It is not mandatory to provide data to the FFT during ready cycles.
sink_real	Input	data	data precision width	Real input data, which represents a signed number of data precision bits.
sink_sop	Input	startofpacket	1	Indicates the start of the incoming FFT frame.
sink_valid	Input	valid	1	Asserted when data on the data bus is valid. When sink_valid and sink_ready are asserted, a data transfer takes place..

continued...



Signal Name	Direction	Avalon-ST Type	Size	Description
sink_data	Input	data	Variable	In Qsys systems, this Avalon-ST-compliant data bus includes all the Avalon-ST input data signals from MSB to LSB: <ul style="list-style-type: none"> • sink_real • sink_imag • fftpts_in • inverse
source_eop	Output	endofpacket	1	Marks the end of the outgoing FFT frame. Only valid when source_valid is asserted.
source_error	Output	error	2	Indicates an error has occurred either in an upstream module or within the FFT module (logical OR of sink_error with errors generated in the FFT).
source_exp	Output	data	6	Streaming, burst, and buffered burst FFTs only. Signed block exponent: Accounts for scaling of internal signal values during FFT computation.
source_imag	Output	data	(data precision width + growth)	Imaginary output data. For burst, buffered burst, streaming, and variable streaming floating point FFTs, the output data width is equal to the input data width. For variable streaming fixed point FFTs, the size of the output data is dependent on the number of stages defined for the FFT and is 2 bits per radix 2^2 stage.
source_ready	Input	ready	1	Asserted by the downstream module if it is able to accept data.
source_real	Output	data	(data precision width + growth)	Real output data. For burst, buffered burst, streaming, and variable streaming floating point FFTs, the output data width is equal to the input data width. For variable streaming fixed point FFTs, the size of the output data is dependent on the number of stages defined for the FFT and is 2 bits per radix 2^2 stage. Variable streaming fixed point FFT only. Growth is $\log_2(N)+1$.
source_sop	Output	startofpacket	1	Marks the start of the outgoing FFT frame. Only valid when source_valid is asserted.
source_valid	Output	valid	1	Asserted by the FFT when there is valid data to output.
source_data	Output	data	Variable	In Qsys systems, this Avalon-ST-compliant data bus includes all the Avalon-ST output data signals from MSB to LSB: <ul style="list-style-type: none"> • source_real • source_imag • fftpts_out

Related Information

- [Avalon Streaming Interface Specification](#)
- [Recommended Design Practices](#)

3.6.2.1. Component Specific Signals

The component specific signals.

**Table 11. Component Specific Signals**

Signal Name	Direction	Size	Description
fftps_in	Input	$\log_2(\text{maximum number of points})$	The number of points in this FFT frame. If you do not specify this value, the FFT can not be a variable length. The default behavior is for the FFT to have fixed length of maximum points. Only sampled at SOP. Always drive <code>fftps_in</code> even if you are not dynamically changing the block size. For a fixed implementation drive it to match the transform length in the parameter editor.
fftps_out	Output	$\log_2(\text{maximum number of points})$	The number of points in this FFT frame synchronized to the Avalon-ST source interface. Variable streaming only.
inverse	Input	1	Inverse FFT calculated if asserted. Only sampled at SOP.

Incorrect usage of the Avalon-ST interface protocol on the sink interface results in a error on `source_error`. [Table 3-8](#) defines the behavior of the FFT when an incorrect Avalon-ST transfer is detected. If an error occurs, the behavior of the FFT is undefined and you must reset the FFT with `reset_n`.

Table 12. Error Handling Behavior

Error	source_error	Description
Missing SOP	01	Asserted when valid goes high, but there is no start of frame.
Missing EOP	10	Asserted if the FFT accepts N valid samples of an FFT frame, but there is no EOP signal.
Unexpected EOP	11	Asserted if EOP is asserted before N valid samples are accepted.

4. Block Floating Point Scaling

Block-floating-point (BFP) scaling is a trade-off between fixed-point and full floating-point FFTs.

In fixed-point FFTs, the data precision needs to be large enough to adequately represent all intermediate values throughout the transform computation. For large FFT transform sizes, an FFT fixed-point implementation that allows for word growth can make either the data width excessive or can lead to a loss of precision.

Floating-point FFTs represents each number as a mantissa with an individual exponent. The improved precision is offset by demand for increased device resources.

In a block-floating point FFT, all of the values have an independent mantissa but share a common exponent in each data block. Data is input to the FFT function as fixed point complex numbers (even though the exponent is effectively 0, you do not enter an exponent).

The block-floating point FFT ensures full use of the data width within the FFT function and throughout the transform. After every pass through a radix-4 FFT, the data width may grow up to $\log_2(42) = 2.5$ bits. The data scales according to a measure of the block dynamic range on the output of the previous pass. The FFT accumulates the number of shifts and then outputs them as an exponent for the entire block. This shifting ensures that the minimum of least significant bits (LSBs) are discarded prior to the rounding of the post-multiplication output. In effect, the block-floating point representation is as a digital automatic gain control. To yield uniform scaling across successive output blocks, you must scale the FFT function output by the final exponent.

In comparing the block-floating point output of the FFT MegaCore function to the output of a full precision FFT from a tool like MATLAB, you must scale the output by $2^{-\text{exponent_out}}$ to account for the discarded LSBs during the transform.

Unlike an FFT block that uses floating point arithmetic, a block-floating-point FFT block does not provide an input for exponents. Internally, the IP core represents a complex value integer pair with a single scale factor that it typically shares among other complex value integer pairs. After each stage of the FFT, the IP core detects the largest output value and scales the intermediate result to improve the precision. The exponent records the number of left or right shifts to perform the scaling. As a result, the output magnitude relative to the input level is:

$\text{output} * 2^{-\text{exponent}}$

For example, if $\text{exponent} = -3$, the input samples are shifted right by three bits, and hence the magnitude of the output is $\text{output} * 2^3$.



After every pass through a radix-2 or radix-4 engine in the FFT core, the addition and multiplication operations cause the data bits width to grow. In other words, the total data bits width from the FFT operation grows proportionally to the number of passes. The number of passes of the FFT/IFFT computation depends on the logarithm of the number of points.

A fixed-point FFT needs a huge multiplier and memory block to accommodate the large bit width growth to represent the high dynamic range. Though floating-point is powerful in arithmetic operations, its power comes at the cost of higher design complexity such as a floating-point multiplier and a floating-point adder. BFP arithmetic combines the advantages of floating-point and fixed-point arithmetic. BFP arithmetic offers a better signal-to-noise ratio (SNR) and dynamic range than does floating-point and fixed-point arithmetic with the same number of bits in the hardware implementation.

In a block-floating-point FFT, the radix-2 or radix-4 computation of each pass shares the same hardware, the IP core reads the data from memory, passes it through the engine, and writes back to memory. Before entering the next pass, the IP core shifts each data sample right (an operation called "scaling") if the addition and multiplication operations produce a carry-out bit. The IP core bases the number of bits that it shifts on the difference in bit growth between the data sample and the maximum data sample it detect in the previous stage. The IP core records the maximum bit growth in the exponent register. Each data sample now shares the same exponent value and data bit width to go to the next core engine. You can reuse the same core engine without incurring the expense of a larger engine to accommodate the bit growth.

The output SNR depends on how many bits of right shift occur and at what stages of the radix core computation they occur. That the signal-to-noise ratio is data dependent and you need to know the input signal to compute the SNR.

4.1. Possible Exponent Values

Depending on the length of the FFT/IFFT, the number of passes through the radix engine is known and therefore the range of the exponent is known. The possible values of the exponent are determined by the following equations:

$P = \text{ceil}\{\log_4 N\}$, where N is the transform length

$R = 0$ if $\log_2 N$ is even, otherwise $R = 1$

Single output range = $(-3P+R, P+R-4)$

Quad output range = $(-3P+R+1, P+R-7)$

These equations translate to the values in [Table A-1](#).

Table 13. Exponent Scaling Values for FFT / IFFT (1)

N	P	Single Output Engine		Quad Output Engine	
		Max (2)	Min (2)	Max (2)	Min (2)
64	3	-9	-1	-8	-4
128	4	-11	1	-10	-2
256	4	-12	0	-11	-3
<i>continued...</i>					

N	P	Single Output Engine		Quad Output Engine	
		Max (2)	Min (2)	Max (2)	Min (2)
512	5	-14	2	-13	-1
1,024	5	-15	1	-14	-2
2,048	6	-17	3	-16	0
4,096	6	-18	2	-17	-1
8,192	7	-20	4	-19	1
16,384	7	-21	3	-20	0

Note to **Table A-1**:

1. This table lists the range of exponents, which is the number of scale events that occurred internally. For IFFT, the output must be divided by N externally. If more arithmetic operations are performed after this step, the division by N must be performed at the end to prevent loss of precision.
2. The maximum and minimum values show the number of times the data is shifted. A negative value indicates shifts to the left, while a positive value indicates shifts to the right.

4.2. Implementing Scaling

To implement the scaling algorithm, follow these steps:

1. Determine the length of the resulting full scale dynamic range storage register. To get the length, add the width of the data to the number of times the data is shifted. For example, for a 16-bit data, 256-point Quad Output FFT/IFFT with Max = -11 and Min = -3. The Max value indicates 11 shifts to the left, so the resulting full scaled data width is 16 + 11, or 27 bits.
2. Map the output data to the appropriate location within the expanded dynamic range register based upon the exponent value. To continue the above example, the 16-bit output data [15..0] from the FFT/IFFT is mapped to [26..11] for an exponent of -11, to [25..10] for an exponent of -10, to [24..9] for an exponent of -9, and so on.
3. Sign extend the data within the full scale register.

4.2.1. Example of Scaling

A sample of Verilog HDL code that illustrates the scaling of the output data (for exponents -11 to -9) with sign extension is shown in the following example:

```

case (exp)
  6'b110101 : //-11 Set data equal to MSBs
  begin
    full_range_real_out[26:0] <= {real_in[15:0],11'b0};
    full_range_imag_out[26:0] <= {imag_in[15:0],11'b0};
  end
  6'b110110 : //-10 Equals left shift by 10 with sign extension
  begin
    full_range_real_out[26] <= {real_in[15]};
    full_range_real_out[25:0] <= {real_in[15:0],10'b0};
  end
endcase

```



```

full_range_imag_out[26] <= {imag_in[15]};
full_range_imag_out[25:0] <= {imag_in[15:0],10'b0};
end

6'b110111 : //-9 Equals left shift by 9 with sign extension

begin
full_range_real_out[26:25] <= {real_in[15],real_in[15]};
full_range_real_out[24:0] <= {real_in[15:0],9'b0};
full_range_imag_out[26:25] <= {imag_in[15],imag_in[15]};
full_range_imag_out[24:0] <= {imag_in[15:0],9'b0};
end

.
.
.

endcase

```

In this example, the output provides a full scale 27-bit word. You must choose how many and which bits must be carried forward in the processing chain. The choice of bits determines the absolute gain relative to the input sample level.

[Figure A-1 on page A-5](#) demonstrates the effect of scaling for all possible values for the 256-point quad output FFT with an input signal level of 0x5000. The output of the FFT is 0x280 when the exponent = -5. The figure illustrates all cases of valid exponent values of scaling to the full scale storage register [26..0]. Because the exponent is -5, you must check the register values for that column. This data is shown in the last two columns in the figure. Note that the last column represents the gain compensated data after the scaling (0x0005000), which agrees with the input data as expected. If you want to keep 16 bits for subsequent processing, you can choose the bottom 16 bits that result in 0x5000. However, if you choose a different bit range, such as the top 16 bits, the result is 0x000A. Therefore, the choice of bits affects the relative gain through the processing chain.

Because this example has 27 bits of full scale resolution and 16 bits of output resolution, choose the bottom 16 bits to maintain unity gain relative to the input signal. Choosing the LSBs is not the only solution or the correct one for all cases. The choice depends on which signal levels are important. One way to empirically select the proper range is by simulating test cases that implement expected system data. The output of the simulations must tell what range of bits to use as the output register. If the full scale data is not used (or just the MSBs), you must saturate the data to avoid wraparound problems.

Figure 19. Scaling of Input Data Sample = 0x5000

Bit	Input	Output Data	Exponent										Looking at Exponent = -5			
			-11	-10	-9	-8	-7	-6	-5	-4	-3	Taking All Bits	Sign Extend / Pad			
	5000 H	280 H														
28			0													0
25			0	0												0
24			0	0	0											0
23			0	0	0	0										0
22			0	0	0	0	0									0
21			0	0	0	0	0	0								0
20			1	0	0	0	0	0	0						0	0
19			0	1	0	0	0	0	0	0					0	0
18			1	0	1	0	0	0	0	0	0				0	0
17			0	1	0	1	0	0	0	0	0	0			0	0
16			0	0	1	0	1	0	0	0	0	0			0	0
15	0	0	0	0	0	1	0	1	0	0	0	0			0	0
14	1	0	0	0	0	0	0	1	0	1	0	0			1	1
13	0	0	0	0	0	0	0	0	1	0	1	0			0	0
12	1	0	0	0	0	0	0	0	0	1	0	1			1	1
11	0	0	0	0	0	0	0	0	0	0	1	0			0	0
10	0	0	0	0	0	0	0	0	0	0	0	1			0	0
9	0	1			0	0	0	0	0	0	0	0			0	0
8	0	0			0	0	0	0	0	0	0	0			0	0
7	0	1					0	0	0	0	0	0			0	0
6	0	0						0	0	0	0	0			0	0
5	0	0							0	0	0	0			0	0
4	0	0								0	0	0			0	0
3	0	0									0	0			0	0
2	0	0										0			0	0
1	0	0													0	0
0	0	0													0	0

4.3. Unity Gain in an IFFT+FFT Pair

Given sufficiently high precision, such as with floating-point arithmetic, in theory you can obtain unity gain when you cascade an IFFT and FFT. However, in BFP arithmetic, pay special attention to the exponent values of the IFFT/FFT blocks to achieve the unity gain. This section explains the steps to derive a unity gain output from an IFFT/FFT IP Core pair, using BFP arithmetic.

BFP arithmetic does not provide an input for the exponent, so you must keep track of the exponent from the IFFT block if you are feeding the output to the FFT block immediately thereafter and divide by N at the end to acquire the original signal magnitude.



Figure 20. Derivation to Achieve IFFT/FFT Pair Unity Gain

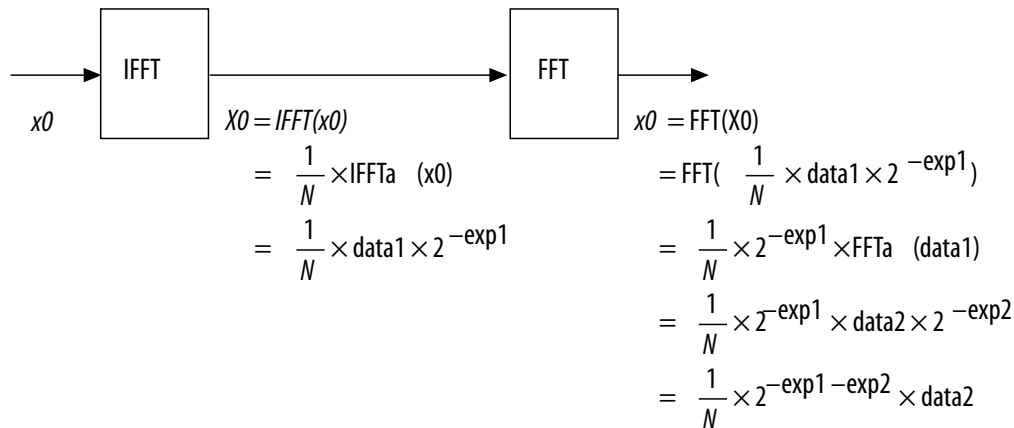

where:

$x0$ = Input data to IFFT

$X0$ = Output data from IFFT

N = number of points

$data1$ = IFFT output data and FFT input data

$data2$ = FFT output data

$exp1$ = IFFT output exponent

$exp2$ = FFT output exponent

$IFFTa$ = IFFT

$FFTa$ = FFT

Any scaling operation on $X0$ followed by truncation loses the value of $exp1$ and does not result in unity gain at $x0$. Any scaling operation must be done on $X0$ only when it is the final result. If the intermediate result $X0$ is first padded with $exp1$ number of zeros and then truncated or if the data bits of $X0$ are truncated, the scaling information is lost.

To keep unity gain, you can pass the $exp1$ value to the output of the FFT block. Alternatively, preserve the full precision of $data1 \times 2^{-exp1}$ and use this value as input to the FFT block. The second method requires a large size for the FFT to accept the input with growing bit width from IFFT operations. The resolution required to accommodate this bit width in most cases, exceeds the maximum data width supported by the IP core.

Related Information

[Achieving Unity Gain in Block Floating Point IFFT+FFT Pair design example](#)

5. Document Revision History

FFT IP Core User Guide revision history.

Date	Version	Changes
2018.05.31	17.1	<ul style="list-style-type: none"> Corrected the statement: "The IP asserts both the sink_valid and the sink_ready for a successful data transfer." Corrected 2m to 2^m
2017.11.06	17.1	<ul style="list-style-type: none"> Added support for Intel Cyclone 10 devices. Removed bit-reversed option. Removed <i>input and output orders</i> topic.
2017.01.14	16.1.1	<ul style="list-style-type: none"> Removed DC centred option from variable streaming input and output option orders. Removed product ID and vendor ID codes.
2016.11.11	16.1	Added note about <i>fftpts</i> signal.
2016.08.01	16.1S10	Added support for Stratix 10 devices
2016.05.01	16.0	Added MATLAB simulation flow.
2015.10.01	15.1	Added more info to sink_data and source_data signals
2014.12.15	14.1	<ul style="list-style-type: none"> Added more detail to source_data and sink_data signal descriptions. Added hard-floating point option for Arria 10 devices in the Complex Multiplier Options Reworded DSP Block Resource Optimization description Added block floating point option in parameters table. Reordered parameters in parameters table. Removed the following parameters: <ul style="list-style-type: none"> Twiddle ROM Distribution Use M-RAM or M144K blocks Implement appropriate logic functions in RAM Structure Implement Multipliers in Global enable clock signal Removed Stratix V devices only comment for DSP Resource Optimization parameter. Added final support for Arria 10 and MAX 10 devices
August 2014	14.0 Arria 10 Edition	<ul style="list-style-type: none"> Added support for Arria 10 devices. Added new source_data bus description. Added Arria 10 generated files description. Removed table with generated file descriptions. Removed clk_ena
<i>continued...</i>		

5. Document Revision History

UG-FFT | 2017.11.06



Date	Version	Changes
June 2014	14.0	<ul style="list-style-type: none">• Removed Cyclone III and Stratix III device support• Added support for MAX 10 FPGAs.• Added instructions for using IP Catalog
November 2013	13.1	<ul style="list-style-type: none">• Added more information to variable streaming I/O dataflow.• Removed device support for following devices:<ul style="list-style-type: none">– HardCopy II, HardCopy III, HardCopy IV E, HardCopy IV GX– Stratix, Stratix GX, Stratix II, Stratix II GX– Cyclone, Cyclone II– Arria GX
November 2012	12.1	Added support for Arria V GZ devices.



A. FFT IP Core User Guide Document Archive

If an IP core version is not listed, the user guide for the previous IP core version applies.

IP Core Version	User Guide
16.1	FFT IP Core User Guide
15.1	FFT IP Core User Guide
15.0	FFT IP Core User Guide
14.1	FFT IP Core User Guide