

You can use the ALTGX\_RECONFIG MegaWizard™ Plug-In Manager in the Quartus® II software to create and modify design files for the Stratix® IV device family. This chapter describes the different Quartus II settings for dynamic reconfiguration in the ALTGX\_RECONFIG MegaWizard Plug-In Manager.

The MegaWizard Plug-In Manager helps you create or modify design files that contain custom megafunction variations. These auto-generated MegaWizard files can then be instantiated in a design file. The MegaWizard Plug-In Manager allows you to specify options for the ALTGX\_RECONFIG megafunction.

Start the MegaWizard Plug-In Manager using one of the following methods:

- Choose the **MegaWizard Plug-In Manager** command (Tools menu).
- When working in the **Block Editor** (schematic symbol), open the Edit menu and choose **Insert Symbol**. The **Symbol** dialog box appears. In the **Symbol** dialog box, click **MegaWizard Plug-In Manager**.
- Start the stand-alone version of the MegaWizard Plug-In Manager by typing the following command at the command prompt: `qmegawiz`.

## Dynamic Reconfiguration

This section describes the options available on the individual pages of the ALTGX\_RECONFIG MegaWizard Plug-In Manager.



The MegaWizard Plug-In Manager provides a warning if any of the settings you choose are illegal.

Figure 3–1 shows the first page of the MegaWizard Plug-In Manager. To generate an ALTGX\_RECONFIG custom megafunction variation, select **Create a new custom megafunction variation**. Click **Next**.

**Figure 3–1. MegaWizard Plug-In Manager (Page 1)**

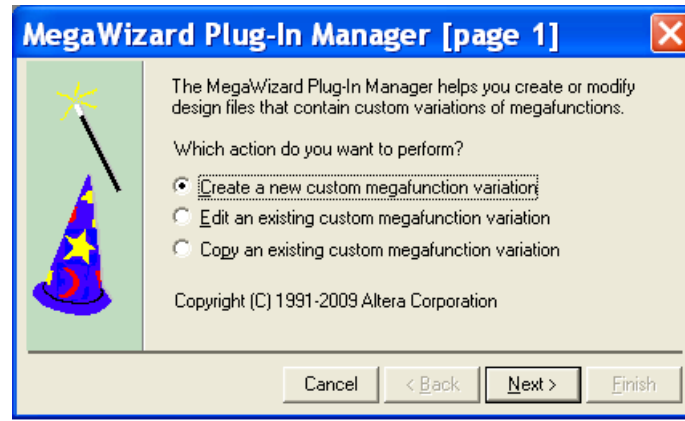

Figure 3–2 shows the second page of the MegaWizard Plug-In Manager. Select the following options (click **Next** when you are done):

1. In the list of megafunctions on the left, click the “+” icon beside the I/O item. From the options presented, choose **ALTGX\_RECONFIG megafunction**.
2. From the drop-down menu beside **Which device family will you be using?**, select **Stratix IV**.
3. From the radio buttons under **Which type of output file do you want to create?**, choose your output file format (**AHDL**, **VHDL**, or **Verilog HDL**).
4. In the box beneath **What name do you want for the output file?**, enter the file name or click the **Browse** button to search for it.



For the design to compile successfully, always enable the dynamic reconfiguration controller for all the ALTGX instances in the design.

Figure 3-2. MegaWizard Plug-In Manager—ALTGX\_RECONFIG (Page 2)

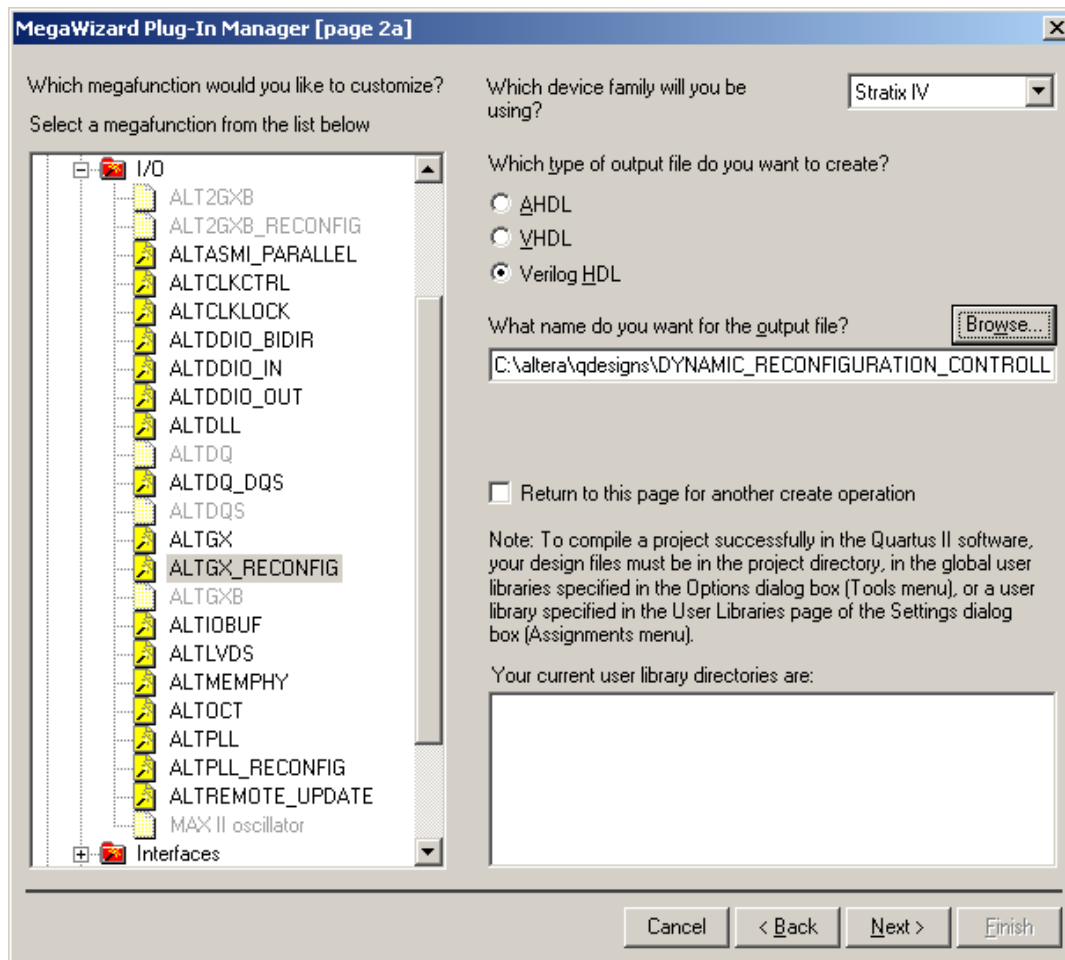

Figure 3-3 shows page 3 of the ALTGX\_RECONFIG MegaWizard Plug-In Manager. From the drop-down menu, select the number of channels controlled by the dynamic reconfiguration controller.

**Figure 3-3. MegaWizard Plug-In Manager—ALTGX\_RECONFIG (Reconfiguration Settings)**

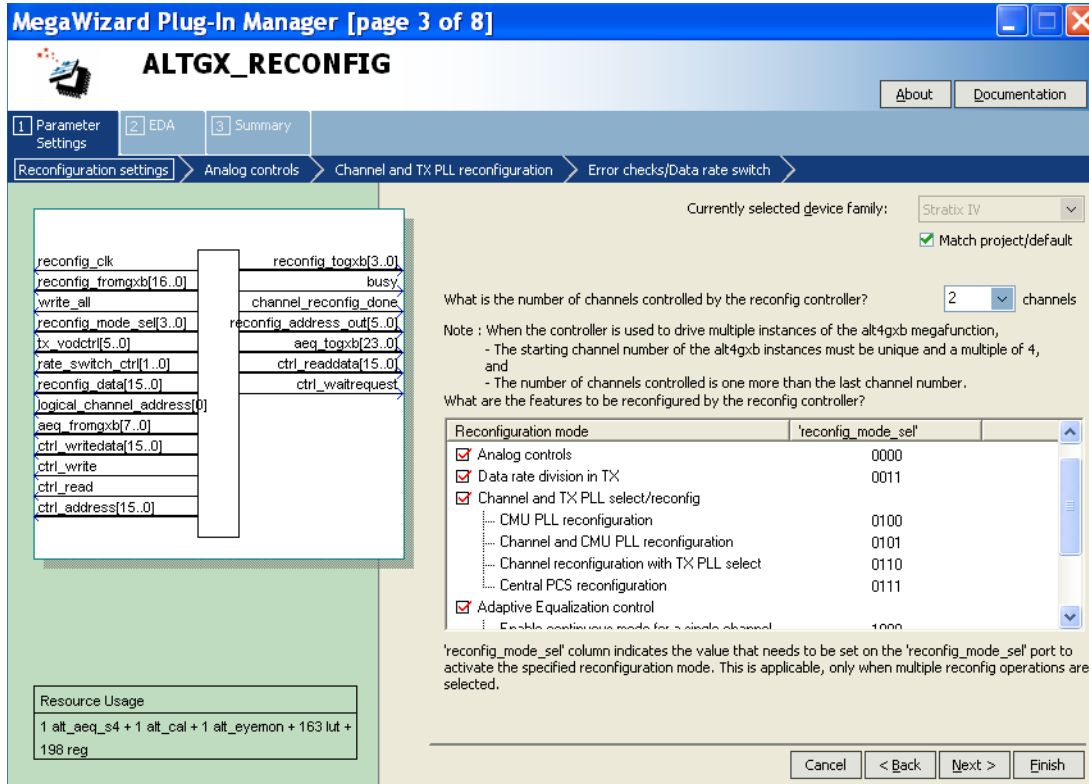

Table 3-1 lists the available options on page 3 of the MegaWizard Plug-In Manager for your ALTGX\_RECONFIG custom megafunction variation. Select the **Match project/default** option if you want to change the device **Currently selected device family** options.

Make your selections on page 3, then click **Next**.

**Table 3-1. MegaWizard Plug-In Manager Options (Page 3) (Part 1 of 2)**

ALTGX_RECONFIG Setting	Description	Reference
<p>What is the number of channels controlled by the reconfig controller?</p>	<p>Determine the highest logical channel address among all the ALTGX instances connected to the ALTGX_RECONFIG instance. Round it up to the next multiple of four and set that number in this option.</p> <p>Depending on this setting, the ALTGX_RECONFIG MegaWizard Plug-in Manager generates the appropriate signal width for the interface signal (<i>reconfig_fromgxb</i>) between the ALTGX_RECONFIG and the ALTGX instances. It also gives the necessary bus width for all the selected physical media attachment (PMA) signals.</p> <p>Depending on the number of channels set, the resource estimate changes because this is a soft implementation that uses fabric logic resources. The resource estimate is shown in the bottom left of Page 3 of the MegaWizard Plug-in Manager.</p>	<p>“Total Number of Channels Controlled by the ALTGX_RECONFIG Instance” section of the <i>Dynamic Reconfiguration in Stratix IV Devices</i> chapter.</p>

Table 3-1. MegaWizard Plug-In Manager Options (Page 3) (Part 2 of 2)

ALTGX_RECONFIG Setting	Description	Reference
What are the features to be reconfigured by the reconfig controller?	<p>This feature is always enabled by default:</p> <ul style="list-style-type: none"> <li>■ <b>Offset Cancellation for Receiver Channels</b>—After the device powers up, the dynamic reconfiguration controller performs offset cancellation on the receiver portion of all the transceiver channels controlled by it.</li> </ul> <p>These features are available for selection:</p> <ul style="list-style-type: none"> <li>■ <b>Analog Controls</b>—Allows dynamic reconfiguration of PMA controls such as Equalization, Pre-emphasis, DC Gain, and voltage offset differential (VOD).</li> <li>■ <b>Data rate division in TX</b>—Allows dynamic reconfiguration of the transmitter local divider settings to 1, 2, or 4. The transmitter channel data rate is reconfigured based on the local divider settings.</li> <li>■ <b>Channel and TX PLL select/reconfig</b>—The following features are available under this option: <ul style="list-style-type: none"> <li>■ <b>CMU PLL Reconfiguration</b>—Allows you to dynamically reconfigure the clock multiplier unit (CMU) phase-locked loop (PLL) to a different data rate.</li> <li>■ <b>Channel and CMU PLL reconfiguration</b>—Allows the dynamic reconfiguration of the transceiver channel from one functional mode to another and also the CMU PLL reconfiguration.</li> <li>■ <b>Channel reconfiguration with TX PLL select</b>—Allows you to select additional transmitter PLLs for the transceiver channel and reconfigure the functional mode of the channel.</li> <li>■ <b>Central Control Unit reconfiguration</b>—Allows you to reconfigure bonded mode configurations from one to another.</li> </ul> </li> <li>■ <b>Adaptive Equalization Control</b>—Allows you to reconfigure the adaptive equalization hardware (AEQ) in the receiver portion of the transceivers. <b>Enable one time mode for a single channel</b> mode is a single stable equalization value is set up and locked for the specified channel by the AEQ hardware.</li> </ul>	<p>“Offset Cancellation” section of the <i>Dynamic Reconfiguration in Stratix IV Devices</i> chapter.</p> <p>“PMA Controls Reconfiguration Mode Details” section, “Data Rate Division in Transmitter Mode Details” section, “CMU PLL Reconfiguration Mode Details” section, “Channel and CMU PLL Reconfiguration Mode Details” section, “Channel reconfiguration with TX PLL Select Mode Details” section, and the “Adaptive Equalization (AEQ)” section in the <i>Dynamic Reconfiguration in Stratix IV Devices</i> chapter.</p>
What are the features to be reconfigured by the reconfig controller?	<ul style="list-style-type: none"> <li>■ <b>EyeQ control</b>—Allows you to reconfigure the EyeQ hardware in the receiver portion of the transceivers.</li> </ul>	<p>“EyeQ” section in the <i>Dynamic Reconfiguration in Stratix IV Devices</i> chapter.</p>

Figure 3-4 shows page 4 of the ALTGX\_RECONFIG MegaWizard Plug-In Manager.

Figure 3-4. MegaWizard Plug-In Manager—ALTGX\_RECONFIG (Analog Controls)

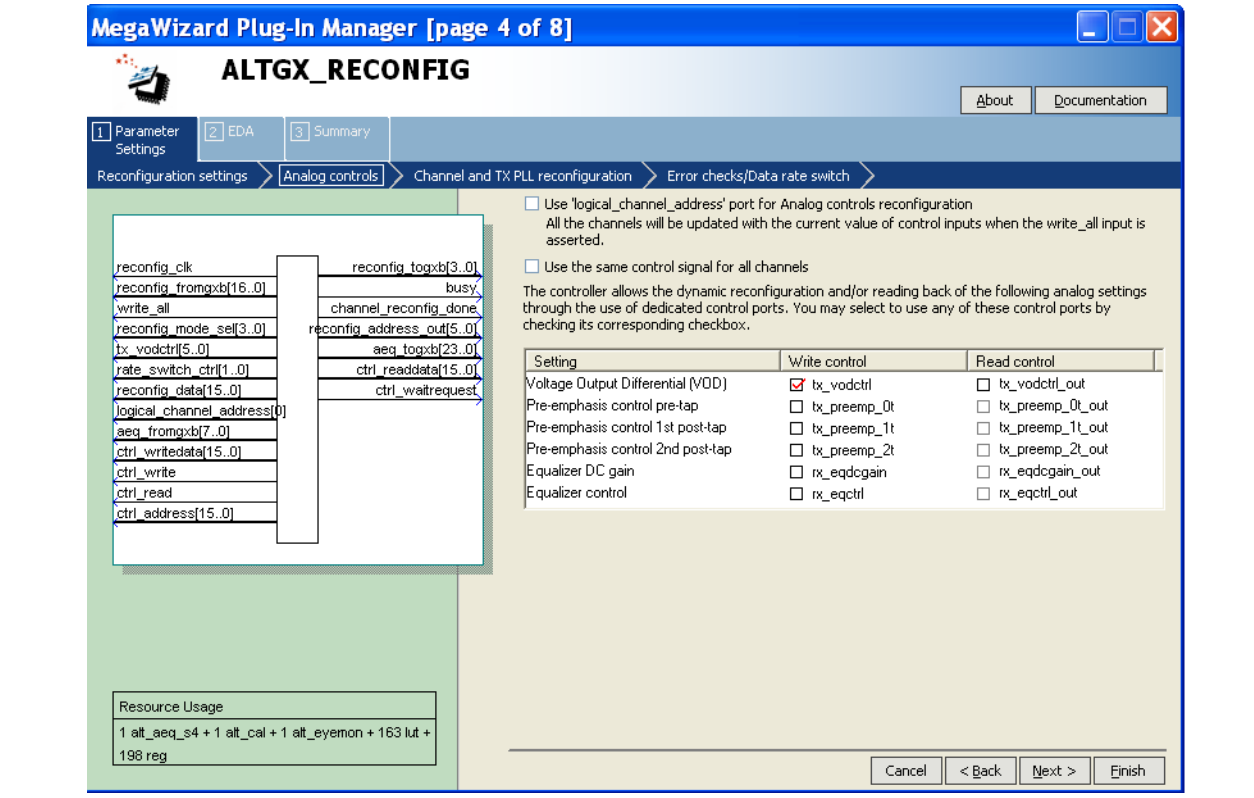

Table 3–2 lists the available options on page 4 of the MegaWizard Plug-In Manager for your ALTGX\_RECONFIG custom megafunction variation.

Make your selections on page 4, then click **Next**.

**Table 3–2. MegaWizard Plug-In Manager Options (Page 4) (Part 1 of 2)**

ALTGX_RECONFIG Setting	Description	Reference
Use 'logical_channel_address' port for Analog controls reconfiguration	<p>This option is applicable only for Analog controls reconfiguration and is available for selection when the number of channels controlled by the ALTGX_RECONFIG instance is more than one. The dynamic reconfiguration controller reconfigures only the channel whose logical channel address is specified at the logical_channel_address port.</p> <p>The width of this port is selected by the ALTGX_RECONFIG MegaWizard Plug-In Manager depending on the number of channels controlled by the dynamic reconfiguration controller. The maximum width of the logical_channel_address port is 9 bits.</p>	<p>“Dynamic Reconfiguration Controller Port List” and “Method 1—Using the logical_channel_address Port” sections of the <i>Dynamic Reconfiguration in Stratix IV Devices</i> chapter.</p>
Use the same control signal for all channels	<p>This option is available for selection when the number of channels controlled by the ALTGX_RECONFIG instance is more than one. When you enable this option, the dynamic reconfiguration controller writes the same control signals to all the channels connected to it.</p> <p>You cannot select this option if you enable the <b>Use 'logical_channel_address' port for Analog controls reconfiguration</b> option.</p>	<p>Method 2 and Method 3 of the “PMA Controls Reconfiguration Mode Details” section of the <i>Dynamic Reconfiguration in Stratix IV Devices</i> chapter.</p>



**Table 3-2. MegaWizard Plug-In Manager Options (Page 4) (Part 2 of 2)**

ALTX_RECONFIG Setting	Description	Reference
Write Control	<p>The PMA control ports available to write various analog settings to the transceiver channels controlled by the dynamic reconfiguration controller are as follows:</p> <ul style="list-style-type: none"> <li>■ tx_vodctrl—V<sub>OD</sub>; 3 bits per channel</li> <li>■ tx_preemp_0t—Pre-emphasis control pre-tap; 5 bits per channel</li> <li>■ tx_preemp_1t—Pre-emphasis control 1st post-tap; 5 bits per channel</li> <li>■ tx_preemp_2t—Pre-emphasis control 2nd post-tap; 5 bits per channel</li> <li>■ rx_eqdcgain—Equalizer DC gain; 3 bits per channel</li> <li>■ rx_eqctrl—Equalizer control; 4 bits per channel</li> </ul> <p>These are optional signals. The signal widths are based on the setting you entered for the <b>What is the number of channels controlled by the reconfig controller?</b> option and whether you enabled the <b>Use 'logical_channel_address' port for Analog controls reconfiguration</b> option. The port width is also determined by the <b>Use the same control signal for all channels</b> option.</p> <p>At least one of these PMA control ports must be enabled to configure and use the dynamic reconfiguration controller.</p>	<p>“Dynamically Reconfiguring PMA Controls” section of the <i>Dynamic Reconfiguration in Stratix IV Devices</i> chapter.</p>
Read Control	<p>The PMA control ports available to read the existing values from the transceiver channels controlled by the dynamic reconfiguration controller are as follows:</p> <ul style="list-style-type: none"> <li>■ tx_vodctrl_out—V<sub>OD</sub>; 3 bits per channel</li> <li>■ tx_preemp_0t_out—Pre-emphasis control pre-tap; 5 bits per channel</li> <li>■ tx_preemp_1t_out—Pre-emphasis control 1st post-tap; 5 bits per channel</li> <li>■ tx_preemp_2t_out—Pre-emphasis control 2nd post-tap; 5 bits per channel</li> <li>■ rx_eqdcgain_out—Equalizer DC gain; 3 bits per channel</li> <li>■ rx_eqctrl_out—Equalizer control; 4 bits per channel</li> </ul> <p>These are optional signals. The signal widths are based on the setting you entered for the <b>What is the number of channels controlled by the reconfig controller?</b> option and whether you enabled the <b>Use 'logical_channel_address' port for Analog controls reconfiguration</b> option.</p> <p>The PMA controls are available for selection only if you select the corresponding write control. Read and write transactions cannot be performed simultaneously.</p>	

Figure 3-5 shows page 5 of the ALTGX\_RECONFIG MegaWizard Plug-In Manager.

Figure 3-5. MegaWizard Plug-In Manager—ALTGX\_RECONFIG (Channel and TX/PLL Reconfiguration)

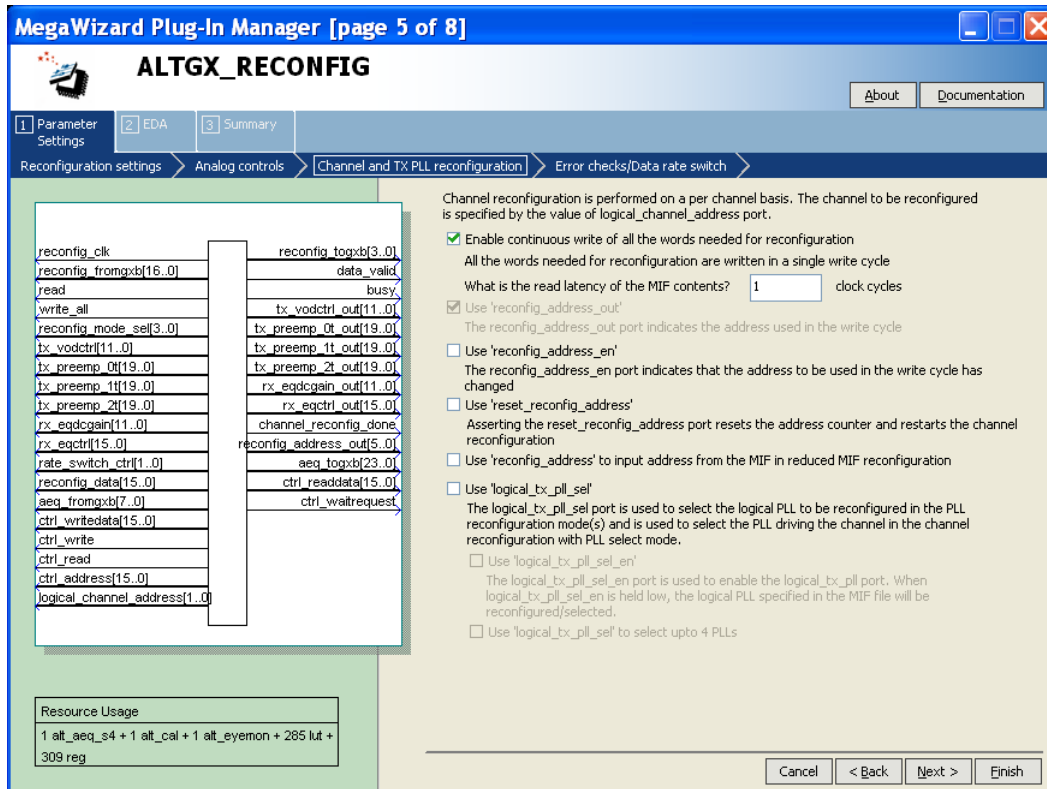

Table 3-4 lists the available options on page 5 of the MegaWizard Plug-In Manager for your ALTGX\_RECONFIG custom megafunction variation.

Table 3-3. MegaWizard Plug-In Manager Options (Page 5) (Part 1 of 2)

ALTGX_RECONFIG Setting	Description	Reference
Enable continuous write of all the words needed for reconfiguration.	For a continuous write operation, select the <b>Enable continuous write of all the words needed for reconfiguration</b> option to pulse the write_all signal once to write an entire memory initialization file (.mif).	“Dynamic Reconfiguration Controller Port List” section in the <i>Dynamic Reconfiguration in Stratix IV Devices</i> chapter.
What is the read latency of the MIF contents?	This option is available only if you have selected the <b>Enable continuous write of all the words needed for reconfiguration</b> option. Enter the desired latency in terms of the reconfig_clk cycles it takes for each .mif word to be present at the reconfig_data port. For more information, refer to Figure 3-6.	“Dynamic Reconfiguration Controller Port List” section in the <i>Dynamic Reconfiguration in Stratix IV Devices</i> chapter.

**Table 3-3. MegaWizard Plug-In Manager Options (Page 5) (Part 2 of 2)**

ALTGX_RECONFIG Setting	Description	Reference
Use 'reconfig_address_out'	This option is enabled by default when you select the <b>Channel and TX PLL select/reconfig</b> option. The value on <code>reconfig_address_out[5:0]</code> indicates the address associated with the words in the <b>.mif</b> , which contains the dynamic reconfiguration instructions. The dynamic reconfiguration controller automatically increments the address at the end of each <b>.mif</b> write transaction.	"Dynamic Reconfiguration Controller Port List" section in the <i>Dynamic Reconfiguration in Stratix IV Devices</i> chapter.
Use 'reconfig_address_en'	When high, this optional output status signal indicates that the address used in the <b>.mif</b> write transaction cycle has changed. This signal is asserted when the <b>.mif</b> write transaction is completed (when the <code>busy</code> signal is de-asserted).	"Dynamic Reconfiguration Controller Port List" section in the <i>Dynamic Reconfiguration in Stratix IV Devices</i> chapter.
Use 'reset_reconfig_address'	When asserted, this optional control signal resets <code>reconfig_address_out</code> (the current reconfiguration address) to <b>0</b> .	"Dynamic Reconfiguration Controller Port List" section in the <i>Dynamic Reconfiguration in Stratix IV Devices</i> chapter.
Use 'logical_tx_pll_sel'	This is an optional control signal. The <code>logical_tx_pll_sel[1:0]</code> signal refers to the logical reference index of the CMU PLL. The functionality of the signal depends on the feature activated, as shown below: <ul style="list-style-type: none"> <li>■ <b>CMU PLL reconfiguration</b>—The corresponding CMU PLL is reconfigured based on the value at <code>logical_tx_pll_sel[1:0]</code>.</li> <li>■ <b>Channel and CMU PLL reconfiguration</b>—The corresponding CMU PLL is reconfigured based on the value at this signal. The transceiver channel listens to the CMU PLL selected by <code>logical_tx_pll_sel[1:0]</code>.</li> <li>■ <b>Channel reconfiguration with TX PLL select</b>—The transceiver channel listens to the TX PLL selected by <code>logical_tx_pll_sel[1:0]</code>.</li> </ul>	"Guidelines for logical_tx_pll_sel and logical_tx_pll_sel_en Ports" section in the <i>Dynamic Reconfiguration in Stratix IV Devices</i> chapter.
Use 'logical_tx_pll_sel_en'	This is an optional control signal. When you enable this signal, the value set on the <code>logical_tx_pll_sel[1:0]</code> signal is valid only if the <code>logical_tx_pll_sel_en</code> is set to <b>1</b> .	"Guidelines for logical_tx_pll_sel and logical_tx_pll_sel_en Ports" section in the <i>Dynamic Reconfiguration in Stratix IV Devices</i> chapter.

Figure 3-6 shows that the read latency of the .mif contents is 2, as it takes two reconfig\_clk cycles for the .mif data to become available on the reconfig\_data port after providing address on the reconfig\_address\_out port.

Figure 3-6. Read Latency

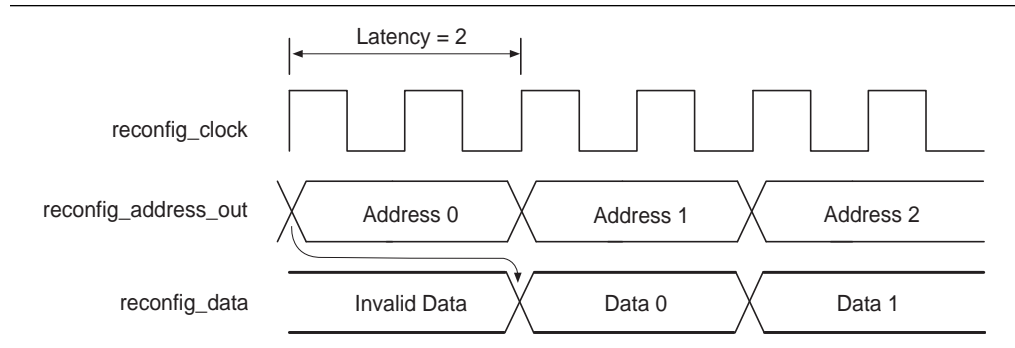

Figure 3-7 shows page 6 of the ALTGX\_RECONFIG MegaWizard Plug-In Manager.

Figure 3-7. MegaWizard Plug-In Manager—ALTGX\_RECONFIG (Error Checks/Data Rate Switch)

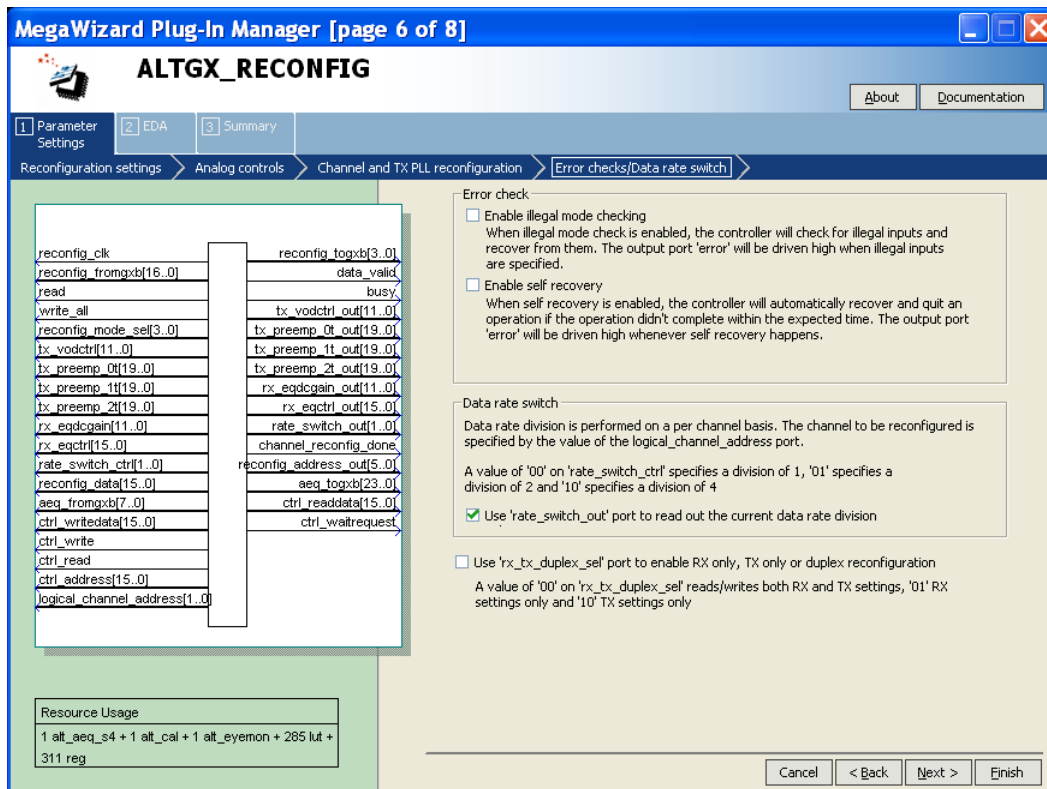

Table 3-4 lists the available options on page 6 of the MegaWizard Plug-In Manager for your ALTGX\_RECONFIG custom megafunction variation.

Make your selections on page 6, then click **Next**.

**Table 3-4. MegaWizard Plug-In Manager Options (Page 6)**

ALTGX_RECONFIG Setting	Description	Reference
Enable illegal mode checking	When you select this option, the ALTGX_RECONFIG MegaWizard Plug-In Manager provides the <code>error</code> output port. The dynamic reconfiguration controller detects the error conditions within two <code>reconfig_clk</code> cycles, de-asserts the <code>busy</code> signal, and asserts the error signal for two <code>reconfig_clk</code> cycles.	“Error Indication During Dynamic Reconfiguration” section of the <i>Dynamic Reconfiguration in Stratix IV Devices</i> chapter.
Enable self recovery	When you select this option, the controller automatically recovers if the operation did not complete within the expected time. The error signal is driven high whenever the controller performs a self recovery.	“Error Indication During Dynamic Reconfiguration” section of the <i>Dynamic Reconfiguration in Stratix IV Devices</i> chapter.
Use <code>rate_switch_out</code> port to read out the current data rate division	The <code>rate_switch_out[1:0]</code> signal is available when you select <b>Data Rate Division in TX</b> mode. You can read the existing local divider settings of a transmitter channel at this port. The decoding for this signal is listed below: 2'b00—Division of 1 2'b01—Division of 2 2'b10—Division of 4 2'b11—Not supported	“Data Rate Division in Transmitter Mode Details” mode section in the <i>Dynamic Reconfiguration in Stratix IV Devices</i> chapter.
Use the <code>rx_tx_duplex_sel</code> port to enable RX only, TX only or duplex configuration	You can read or write the receiver and transmitter settings, only the receiver settings, or only the transmitter settings, based on the value you set at the <code>rx_tx_duplex_sel[1:0]</code> port; <ul style="list-style-type: none"> <li>■ 2'b00—Duplex mode</li> <li>■ 2'b01—RX only mode</li> <li>■ 2'b10—TX only mode</li> <li>■ 2'b11—unsupported value (do not use this value)</li> </ul> If you disable the <code>rx_tx_duplex_sel[1:0]</code> port, the dynamic reconfiguration controller reads or writes both the receiver and transmitter settings.	“Dynamically Reconfiguring PMA Controls” section of the <i>Dynamic Reconfiguration in Stratix IV Devices</i> chapter.

Figure 3-8 shows page 7 (the Simulation Libraries page) of the MegaWizard Plug-In Manager, which is used for dynamic reconfiguration selection.

Make your selections, then click Next.

**Figure 3-8. MegaWizard Plug-In Manager—ALTGX\_RECONFIG (Simulation Libraries)**

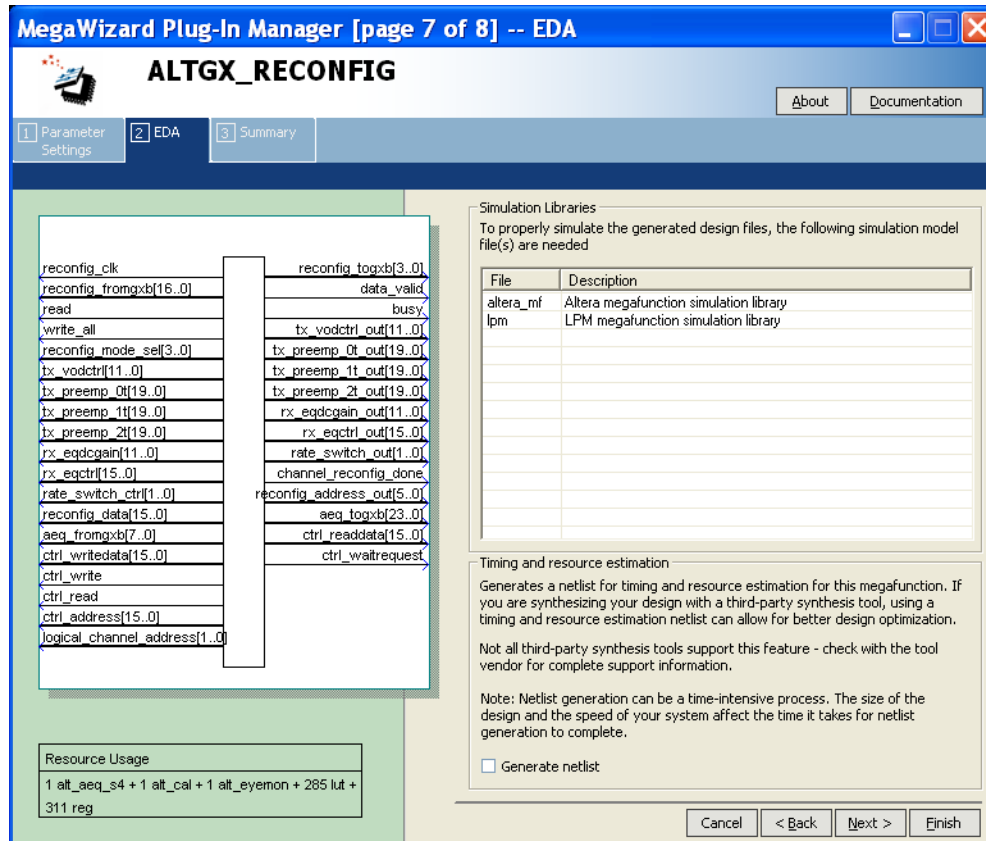

Table 3-5 lists the available option on page 7 of the MegaWizard Plug-In Manager for your ALTGX\_RECONFIG custom Megafunction variation.

Make your selections on page 7, then click Next.

**Table 3-5. MegaWizard Plug-In Manager Options (Page 7)**

ALTGX_RECONFIG Setting	Description	Reference
Generate a netlist for synthesis area and timing estimation	Selecting this option generates a netlist file that third-party synthesis tools can use to estimate the timing and resource usage.	—

Figure 3-9 shows page 8 (the last page) of the MegaWizard Plug-In Manager for the dynamic reconfiguration protocol set up. You can select optional files on this page. After you make your selections, click **Finish** to generate the files.

**Figure 3-9. MegaWizard Plug-In Manager—ALTGX\_RECONFIG (Summary)**

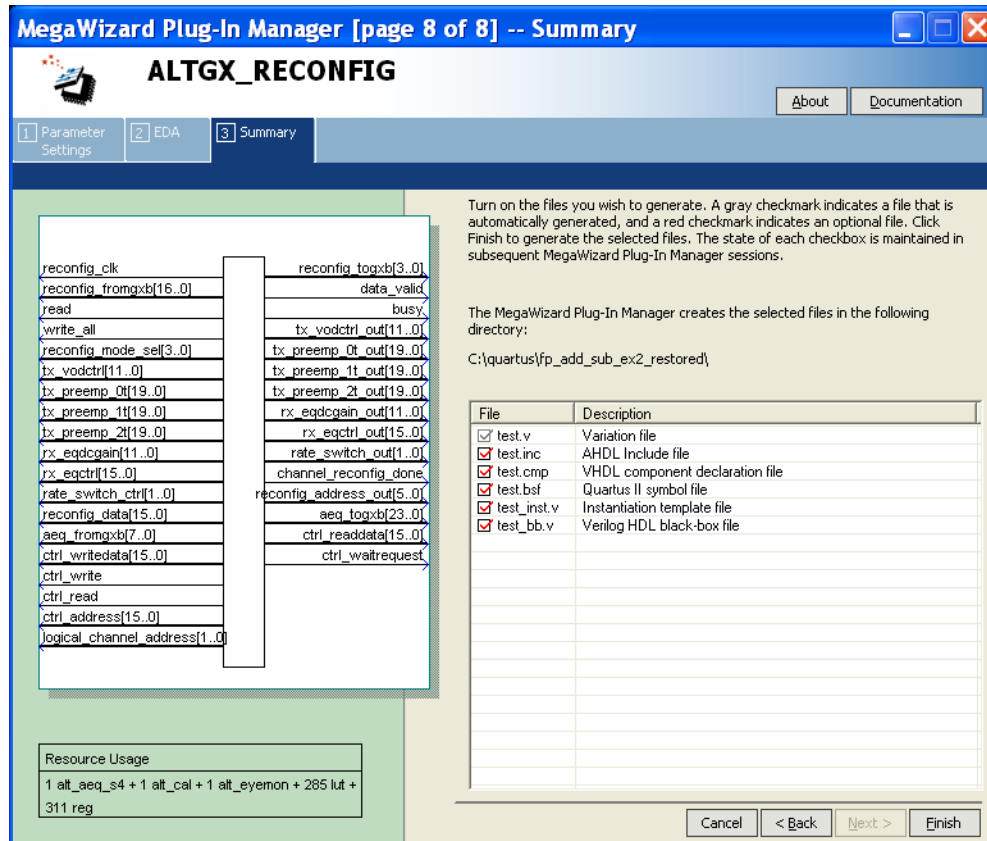

## Document Revision History

Table 3-6 lists the revision history for this chapter.

**Table 3-6. Document Revision History (Part 1 of 2)**

Date	Version	Changes
February 2011	3.1	<ul style="list-style-type: none"> <li>■ Updated Table 3-1.</li> <li>■ Applied new template.</li> <li>■ Updated chapter title.</li> <li>■ Minor text edits.</li> </ul>
November 2009	3.0	<ul style="list-style-type: none"> <li>■ Updated Table 3-1.</li> <li>■ Updated Table 3-3.</li> <li>■ Added Figure 3-6.</li> <li>■ Made minor text edits.</li> </ul>

**Table 3-6. Document Revision History (Part 2 of 2)**

Date	Version	Changes
June 2009	2.1	<ul style="list-style-type: none"><li>■ Updated Table 3-3.</li><li>■ Added introductory sentences to improve search ability.</li><li>■ Minor text edits.</li></ul>
March 2009	2.0	Updated screen shots.
November 2008	1.0	Added chapter to the Stratix IV Device Handbook