

# Intel® Celeron® Processor 500<sup>Δ</sup> Series

Datasheet

---

*For Platforms Based on Mobile Intel® 965 Express Chipset Family*

*January 2008*

*Revision 003*



INFORMATION IN THIS DOCUMENT IS PROVIDED IN CONNECTION WITH INTEL<sup>®</sup> PRODUCTS. NO LICENSE, EXPRESS OR IMPLIED, BY ESTOPPEL OR OTHERWISE, TO ANY INTELLECTUAL PROPERTY RIGHTS IS GRANTED BY THIS DOCUMENT. EXCEPT AS PROVIDED IN INTEL'S TERMS AND CONDITIONS OF SALE FOR SUCH PRODUCTS, INTEL ASSUMES NO LIABILITY WHATSOEVER, AND INTEL DISCLAIMS ANY EXPRESS OR IMPLIED WARRANTY, RELATING TO SALE AND/OR USE OF INTEL PRODUCTS INCLUDING LIABILITY OR WARRANTIES RELATING TO FITNESS FOR A PARTICULAR PURPOSE, MERCHANTABILITY, OR INFRINGEMENT OF ANY PATENT, COPYRIGHT OR OTHER INTELLECTUAL PROPERTY RIGHT.

UNLESS OTHERWISE AGREED IN WRITING BY INTEL, THE INTEL PRODUCTS ARE NOT DESIGNED NOR INTENDED FOR ANY APPLICATION IN WHICH THE FAILURE OF THE INTEL PRODUCT COULD CREATE A SITUATION WHERE PERSONAL INJURY OR DEATH MAY OCCUR.

Intel may make changes to specifications and product descriptions at any time, without notice. Designers must not rely on the absence or characteristics of any features or instructions marked "reserved" or "undefined." Intel reserves these for future definition and shall have no responsibility whatsoever for conflicts or incompatibilities arising from future changes to them. The information here is subject to change without notice. Do not finalize a design with this information.

The products described in this document may contain design defects or errors known as errata which may cause the product to deviate from published specifications. Current characterized errata are available on request.

Contact your local Intel sales office or your distributor to obtain the latest specifications and before placing your product order.

<sup>^</sup>Intel processor numbers are not a measure of performance. Processor numbers differentiate features within each processor family, not across different processor families. See [http://www.intel.com/products/processor\\_number](http://www.intel.com/products/processor_number) for details.

<sup>Φ</sup>64-bit computing on Intel architecture requires a computer system with a processor, chipset, BIOS, operating system, device drivers and applications enabled for Intel<sup>®</sup> 64 architecture. Performance will vary depending on your hardware and software configurations. Consult with your system vendor for more information.

Intel, Celeron, Pentium, Intel Core, Intel Core 2, MMX and the Intel logo are trademarks or registered trademarks of Intel Corporation or its subsidiaries in the United States and other countries.

\*Other names and brands may be claimed as the property of others.

Copyright © 2007, Intel Corporation. All rights reserved.

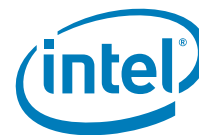

# Contents

---

<b>1</b>	<b>Introduction</b> .....	7
1.1	Terminology .....	8
1.2	References .....	9
<b>2</b>	<b>Low Power Features</b> .....	11
2.1	Clock Control and Low Power States .....	11
2.1.1	Core Low-Power States .....	12
2.1.1.1	C0 State .....	12
2.1.1.2	C1/AutoHALT Powerdown State .....	12
2.1.1.3	C1/MWAIT Powerdown State .....	13
2.1.1.4	Core C2 State .....	13
2.1.1.5	Core C3 State .....	13
2.1.2	Package Low-Power States .....	13
2.1.2.1	Normal State .....	13
2.1.2.2	Stop-Grant State .....	13
2.1.2.3	Stop Grant Snoop State .....	14
2.1.2.4	Sleep State .....	14
2.1.2.5	Deep Sleep State .....	15
2.2	Low-Power FSB Features .....	15
2.3	Processor Power Status Indicator (PSI#) Signal .....	15
<b>3</b>	<b>Electrical Specifications</b> .....	17
3.1	Power and Ground Pins .....	17
3.2	FSB Clock (BCLK[1:0]) and Processor Clocking .....	17
3.3	Voltage Identification .....	17
3.4	Catastrophic Thermal Protection .....	21
3.5	Reserved and Unused Pins .....	21
3.6	FSB Frequency Select Signals (BSEL[2:0]) .....	22
3.7	FSB Signal Groups .....	22
3.8	CMOS Signals .....	23
3.9	Maximum Ratings .....	23
3.10	Processor DC Specifications .....	24
<b>4</b>	<b>Package Mechanical Specifications and Pin Information</b> .....	29
4.1	Package Mechanical Specifications .....	29
4.2	Processor Pinout and Pin List .....	34
4.3	Alphabetical Signals Reference .....	53
<b>5</b>	<b>Thermal Specifications</b> .....	61
5.1	Thermal Diode .....	62
5.1.1	Thermal Diode Offset .....	62
5.2	Intel® Thermal Monitor .....	64
5.3	Digital Thermal Sensor .....	66
5.4	Out of Specification Detection .....	66
5.5	PROCHOT# Signal Pin .....	67



## Figures

1	Package-Level Low-Power States .....	11
2	Core Low-Power States .....	12
3	Active VCC and ICC Loadline Standard Voltage .....	26
4	1-MB Fused Micro-FCPGA Processor Package Drawing (1 of 2) .....	30
5	1-MB Fused Micro-FCPGA Processor Package Drawing (2 of 2) .....	31
6	1-MB Micro-FCPGA Processor Package Drawing (1 of 2) .....	32
7	1-MB Micro-FCPGA Processor Package Drawing (2 of 2) .....	33

## Tables

1	Coordination of Core-Level Low-Power States at the Package Level .....	11
2	Voltage Identification Definition .....	18
3	BSEL[2:0] Encoding for BCLK Frequency .....	22
4	FSB Pin Groups .....	22
5	Processor Absolute Maximum Ratings .....	24
6	DC Voltage and Current Specifications .....	24
7	FSB Differential BCLK Specifications .....	26
8	AGTL+ Signal Group DC Specifications .....	27
9	CMOS Signal Group DC Specifications .....	28
10	Open Drain Signal Group DC Specifications .....	28
11	The Coordinates of the Processor Pins as Viewed from the Top of the Package (Sheet 1 of 2) .....	34
12	The Coordinates of the Processor Pins as Viewed from the Top of the Package (Sheet 2 of 2) .....	35
13	Pin Listing by Pin Name .....	37
14	Pin Listing by Pin Number .....	44
15	Signal Description .....	53
16	Standard Voltage Power Specifications .....	61
17	Thermal Diode ntrim and Diode Correction Toffset .....	63
18	Thermal Diode Interface .....	63
19	Thermal Diode Parameters using Diode Mode .....	63
20	Thermal Diode Parameters using Transistor Model .....	64



## Revision History

---

Document Number	Revision Number	Description	Date
317666	-001	Initial Release	June 2007
317666	-002	Corrected Figures 4, 5, 6, & 7	November 2007
317665	-003	Added the Intel Celeron processor 560	January 2008

§

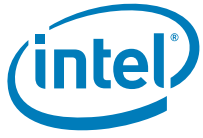



# 1 Introduction

---

This document covers the Intel® Celeron® processor 500 series for platforms based on Mobile Intel® 965 Express Chipset family. It is based on the new Intel® Core™ microarchitecture.

In this document the **Celeron processor 500 series** is referred to as the processor.

The following list provides some of the key features of this processor:

- Single core
- On-die, primary 32-KB instruction cache and 32-KB write-back data cache
- On-die, 1-MB second level shared cache with advanced transfer cache architecture
- 533-MHz source-synchronous front side bus (FSB)
- Supports Intel® architecture with dynamic execution
- Data prefetch logic
- Micro-FCPGA packaging technology
- MMX™ technology, Streaming SIMD Extensions (SSE), Streaming SIMD Extensions 2 (SSE2), Streaming SIMD Extensions 3 (SSE3), and Supplemental Streaming SIMD Extensions 3 (SSSE 3)
- Digital Thermal Sensor (DTS)
- Execute Disable Bit support for enhanced security
- Intel® 64 architecture (formerly Intel® EM64T)<sup>Φ</sup>
- Architectural and performance enhancements of the Core microarchitecture.

**Note:** Unless specified otherwise, all references to the processor in this document are references to the Celeron processor 500 series with a 533-MHz FSB on Mobile Intel 965 Express Chipset family-based systems.



## 1.1 Terminology

Term	Definition
#	A “#” symbol after a signal name refers to an active low signal, indicating a signal is in the active state when driven to a low level. For example, when RESET# is low, a reset has been requested. Conversely, when NMI is high, a nonmaskable interrupt has occurred. In the case of signals where the name does not imply an active state but describes part of a binary sequence (such as address or data), the “#” symbol implies that the signal is inverted. For example, D[3:0] = “HLHL” refers to a hex ‘A’, and D[3:0]# = “LHLH” also refers to a hex “A” (H= High logic level, L= Low logic level). XXXX means that the specification or value is yet to be determined.
AGTL+	Advanced Gunning Transceiver Logic. Used to refer to Assisted GTL+ signaling technology on some Intel processors.
Front Side Bus (FSB)	Refers to the interface between the processor and system core logic (also known as the chipset components).
Intel® 64 Technology	64-bit memory extensions to the IA-32 architecture.
Processor Core	Processor core die with integrated L1 and L2 cache. All AC timing and signal integrity specifications are at the pads of the processor core.
Storage Conditions	Refers to a non-operational state. The processor may be installed in a platform, in a tray, or loose. Processors may be sealed in packaging or exposed to free air. Under these conditions, processor lands should not be connected to any supply voltages, have any I/Os biased or receive any clocks. Upon exposure to “free air” (unsealed packaging or a device removed from packaging material) the processor must be handled in accordance with moisture sensitivity labeling (MSL) as indicated on the packaging material.
V <sub>CC</sub>	The processor core power supply.
V <sub>SS</sub>	The processor ground.





## 1.2 References

Material and concepts in the following documents may be beneficial when reading this document.

Document	Document Number <sup>1</sup>
<i>Intel® Celeron® M 500 Series Processor Specification Update</i>	317667
<i>Mobile Intel® 965 Express Chipset Family Datasheet</i>	316273
<i>Mobile Intel® 965 Express Chipset Family Specification Update</i>	316274
<i>Intel® I/O Controller Hub 8(ICH8) Family Datasheet</i>	313056
<i>Intel® I/O Controller Hub 8(ICH8) Family Specification Update</i>	313057
<i>Intel® 64 and IA-32 Intel® Architectures Software Developer's Manual</i>	
<i>Volume 1: Basic Architecture</i>	253665
<i>Volume 2A: Instruction Set Reference, A-M</i>	253666
<i>Volume 2B: Instruction Set Reference, N-Z</i>	253667
<i>Volume 3A: System Programming Guide, Part 1</i>	253668
<i>Volume 3B: System Programming Guide, Part 2</i>	253669

§

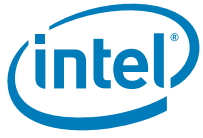



## 2 Low Power Features

### 2.1 Clock Control and Low Power States

The processor supports the C1/AutoHALT, C1/MWAIT, C2, and C3 core low-power states, along with their corresponding package-level states for power management. These package states include Normal, Stop Grant, Stop Grant Snoop, Sleep, and Deep Sleep. The processor’s central power management logic enters a package low-power state by initiating a P\_LVLx (P\_LVL2, P\_LVL3) I/O read to the Intel 965 Express Chipset family. Figure 1 shows the package-level low-power states and Figure 2 shows the core low-power states. Refer to Table 1 for a mapping of core low-power states to package low-power states.

The processor implements two software interfaces for requesting low-power states: MWAIT instruction extensions with sub-state hints and P\_LVLx reads to the ACPI P\_BLK register block mapped in the processor’s I/O address space. The P\_LVLx I/O reads are converted to equivalent MWAIT C-state requests inside the processor and do not directly result in I/O reads on the processor FSB. The monitor address does not need to be setup before using the P\_LVLx I/O read interface. The sub-state hints used for each P\_LVLx read can be configured through the IA32\_MISC\_ENABLES Model Specific Register (MSR).

If the processor encounters a chipset break event while STPCLK# is asserted, it asserts the PBE# output signal. Assertion of PBE# when STPCLK# is asserted indicates to system logic that the processor should return to the Normal state.

Table 1. Coordination of Core-Level Low-Power States at the Package Level

Core States	Package States
C0	Normal
C1 <sup>(1)</sup>	Normal
C2	Stop Grant
C3	Deep Sleep

NOTE: AutoHALT or MWAIT/C1

Figure 1. Package-Level Low-Power States

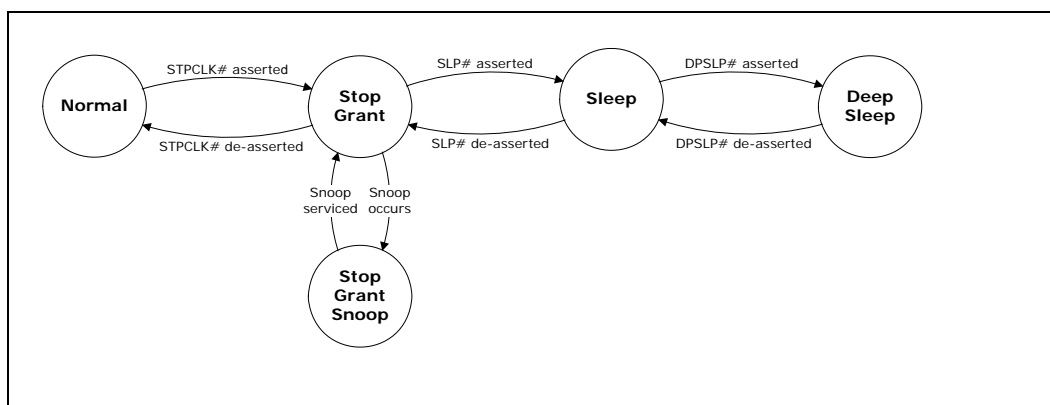
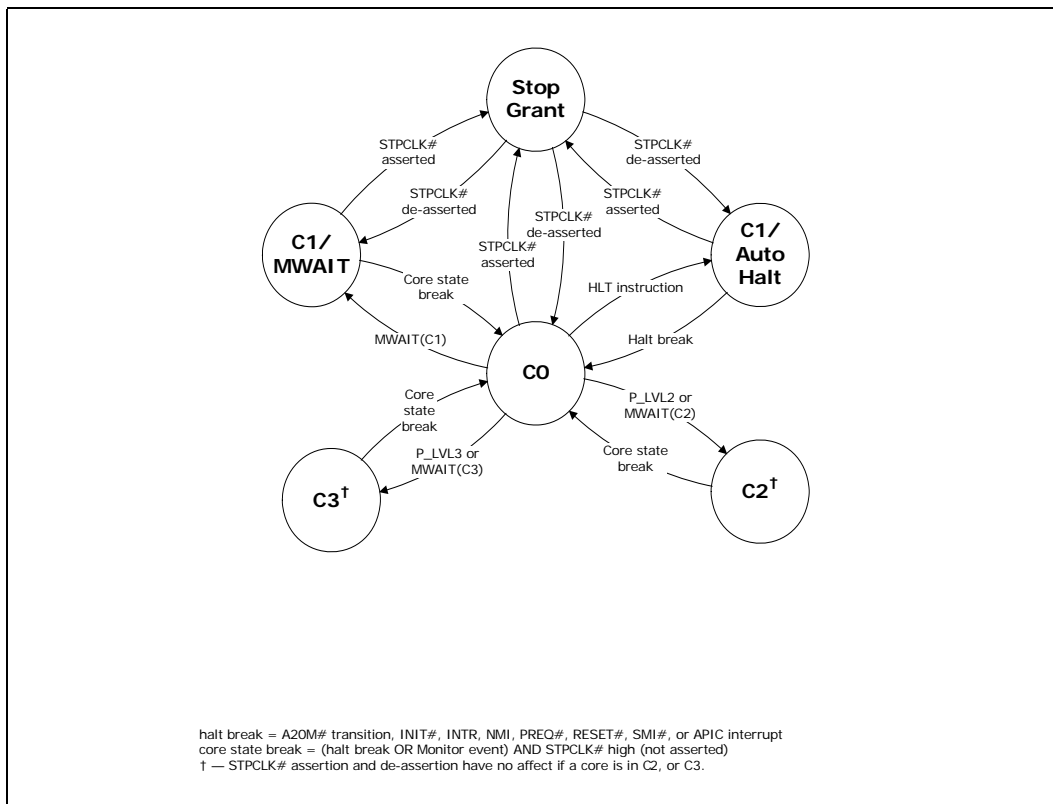

Figure 2. Core Low-Power States



## 2.1.1 Core Low-Power States

### 2.1.1.1 C0 State

This is the normal operating state of the processor.

### 2.1.1.2 C1/AutoHALT Powerdown State

C1/AutoHALT is a low-power state entered when the processor core executes the HALT instruction. The processor core transitions to the C0 state upon the occurrence of SMI#, INIT#, LINT[1:0] (NMI, INTR), or FSB interrupt message. RESET# causes the processor to immediately initialize itself.

**A System Management Interrupt (SMI)** A System Management Interrupt (SMI) handler returns execution to either Normal state or the C1/AutoHALT Powerdown state. See the *Intel® 64 and IA-32 Intel® Architecture Software Developer's Manual, Volume 3A/3B: System Programmer's Guide* for more information.

The system can generate a STPCLK# while the processor is in the C1/AutoHALT Powerdown state. When the system deasserts the STPCLK# interrupt, the processor returns execution to the HALT state.

The processor in C1/AutoHALT powerdown state process only the bus snoops. The processor enters a snooperable sub-state (not shown in Figure 2) to process the snoop and then return to the C1/AutoHALT Powerdown state.



### 2.1.1.3 C1/MWAIT Powerdown State

C1/MWAIT is a low-power state entered when the processor core executes the MWAIT instruction. Processor behavior in the C1/MWAIT state is identical to the C1/AutoHALT state except that there is an additional event that can cause the processor core to return to the C0 state: the Monitor event. See the *Intel® 64 and IA-32 Intel® Architecture Software Developer's Manual, Volume 2A/2B: Instruction Set Reference* for more information.

### 2.1.1.4 Core C2 State

The core of the processor can enter the C2 state by initiating a P\_LVL2 I/O read to the P\_BLK or an MWAIT(C2) instruction, but the processor does not issue a Stop Grant Acknowledge special bus cycle unless the STPCLK# pin is also asserted.

The processor in C2 state processes only the bus snoops. The processor enters a snooperable sub-state (not shown in Figure 2) to process the snoop and then return to the C2 state.

### 2.1.1.5 Core C3 State

Core C3 state is a very low-power state the processor core can enter while maintaining context. The core of the processor can enter the C3 state by initiating a P\_LVL3 I/O read to the P\_BLK or an MWAIT(C3) instruction. Before entering the C3 state, the processor core flushes the contents of its L1 cache into the processor's L2 cache. Except for the caches, the processor core maintains all its architectural state in the C3 state. The Monitor remains armed if it is configured. All of the clocks in the processor core are stopped in the C3 state.

Because the core's caches are flushed, the processor keeps the core in the C3 state when the processor detects a snoop on the FSB. The processor core transitions to the C0 state upon the occurrence of a Monitor event, SMI#, INIT#, LINT[1:0] (NMI, INTR), or FSB interrupt message. RESET# causes the processor core to immediately initialize itself.

## 2.1.2 Package Low-Power States

Package level low-power states are applicable to the processor.

### 2.1.2.1 Normal State

This is the normal operating state for the processor. The processor enters the Normal state when the core is in the C0, C1/AutoHALT, or C1/MWAIT state.

### 2.1.2.2 Stop-Grant State

When the STPCLK# pin is asserted the core of the processor enters the Stop-Grant state within 20 bus clocks after the response phase of the processor-issued Stop Grant Acknowledge special bus cycle. When the STPCLK# pin is deasserted the core returns to the previous core low-power state.

Since the AGTL+ signal pins receive power from the FSB, these pins should not be driven (allowing the level to return to  $V_{CCP}$ ) for minimum power drawn by the termination resistors in this state. In addition, all other input pins on the FSB should be driven to the inactive state.

RESET# causes the processor to immediately initialize itself, but the processor stays in Stop-Grant state. When RESET# is asserted by the system the STPCLK#, SLP#, and DPSLP# pins must be deasserted more than 480  $\mu$ s prior to RESET# deassertion (AC



Specification T45). When re-entering the Stop-Grant state from the Sleep state, STPCLK# should be deasserted ten or more bus clocks after the deassertion of SLP# (AC Specification T75).

While in the Stop-Grant state, the processor services snoops and latch interrupts delivered on the FSB. The processor latches SMI#, INIT# and LINT[1:0] interrupts and services only upon return to the Normal state.

The PBE# signal may be driven when the processor is in Stop-Grant state. PBE# is asserted if there is any pending interrupt or monitor event latched within the processor. Pending interrupts that are blocked by the EFLAGS.IF bit being clear still cause assertion of PBE#. Assertion of PBE# indicates to system logic that the processor should return to the Normal state.

A transition to the Stop Grant Snoop state occurs when the processor detects a snoop on the FSB (see [Section 2.1.2.3](#)). A transition to the Sleep state (see [Section 2.1.2.4](#)) occurs with the assertion of the SLP# signal.

### 2.1.2.3 Stop Grant Snoop State

The processor responds to snoop or interrupt transactions on the FSB while in Stop-Grant state by entering the Stop-Grant Snoop state. The processor stays in this state until the snoop on the FSB has been serviced (whether by the processor or another agent on the FSB) or the interrupt has been latched. The processor returns to the Stop-Grant state once the snoop has been serviced or the interrupt has been latched.

### 2.1.2.4 Sleep State

The Sleep state is a low-power state in which the processor maintains its context, maintains the phase-locked loop (PLL), and stops all internal clocks. The Sleep state is entered through assertion of the SLP# signal while in the Stop-Grant state. The SLP# pin should only be asserted when the processor is in the Stop-Grant state. SLP# assertions while the processor is not in the Stop-Grant state is out of specification and may result in unapproved operation.

In the Sleep state, the processor is incapable of responding to snoop transactions or latching interrupt signals. No transitions or assertions of signals (with the exception of SLP#, DPSP# or RESET#) are allowed on the FSB while the processor is in Sleep state. Snoop events that occur while in Sleep state or during a transition into or out of Sleep state causes unpredictable behavior. Any transition on an input signal before the processor has returned to the Stop-Grant state results in unpredictable behavior.

If RESET# is driven active while the processor is in the Sleep state, and held active as specified in the RESET# pin specification, then the processor resets itself, ignoring the transition through Stop-Grant state. If RESET# is driven active while the processor is in the Sleep state, the SLP# and STPCLK# signals should be deasserted immediately after RESET# is asserted to ensure the processor correctly executes the Reset sequence.

While in the Sleep state, the processor is capable of entering an even lower power state, the Deep Sleep state, by asserting the DPSP# pin. (See [Section 2.1.2.5](#).) While the processor is in the Sleep state, the SLP# pin must be deasserted if another asynchronous FSB event needs to occur.



### 2.1.2.5 Deep Sleep State

Deep Sleep state is a very low-power state the processor can enter while maintaining context. Deep Sleep state is entered by asserting the DPSLP# pin while in the Sleep

state. BCLK may be stopped during the Deep Sleep state for additional platform level power savings. BCLK stop/restart timings on appropriate chipset based platforms with the CK505 clock chip are as follows:

- Deep Sleep entry: the system clock chip may stop/tristate BCLK within 2 BCLKs of DPSLP# assertion. It is permissible to leave BCLK running during Deep Sleep.
- Deep Sleep exit: the system clock chip must drive BCLK to differential DC levels within 2-3 ns of DPSLP# deassertion and start toggling BCLK within 10 BCLK periods.

To re-enter the Sleep state, the DPSLP# pin must be deasserted. BCLK can be re-started after DPSLP# deassertion as described above. A period of 15 microseconds (to allow for PLL stabilization) must occur before the processor can be considered to be in the Sleep state. Once in the Sleep state, the SLP# pin must be deasserted to re-enter the Stop-Grant state.

While in Deep Sleep state, the processor is incapable of responding to snoop transactions or latching interrupt signals. No transitions of signals are allowed on the FSB while the processor is in Deep Sleep state. Any transition on an input signal before the processor has returned to Stop-Grant state results in unpredictable behavior.

## 2.2 Low-Power FSB Features

The processor incorporates FSB low-power enhancements:

- Dynamic On Die Termination disabling
- Low  $V_{CCP}$  (I/O termination voltage)

The On Die Termination on the processor FSB buffers is disabled when the signals are driven low, resulting in power savings. The low I/O termination voltage is on a dedicated voltage plane independent of the core voltage, enabling low I/O switching power at all times.

## 2.3 Processor Power Status Indicator (PSI#) Signal

The PSI# signal is asserted when the processor is in a reduced power consumption state. PSI# can be used to improve light load efficiency of the voltage regulator, resulting in platform power savings and extended battery life. The algorithm that the processor uses for determining when to assert PSI# is different from the algorithm used in previous processors.

§







## 3 Electrical Specifications

---

### 3.1 Power and Ground Pins

For clean, on-chip power distribution, the processor has many  $V_{CC}$  (power) and  $V_{SS}$  (ground) inputs. All power pins must be connected to  $V_{CC}$  power planes while all  $V_{SS}$  pins must be connected to system ground planes. Use of multiple power and ground planes is recommended to reduce  $I \cdot R$  drop. Please refer to the platform design guides for more details. The processor  $V_{CC}$  pins must be supplied the voltage determined by the VID (Voltage ID) pins.

### 3.2 FSB Clock (BCLK[1:0]) and Processor Clocking

BCLK[1:0] directly controls the FSB interface speed as well as the core frequency of the processor. As in previous generation processors, the processor core frequency is a multiple of the BCLK[1:0] frequency.

### 3.3 Voltage Identification

The processor uses seven voltage identification pins, VID[6:0], to support automatic selection of power supply voltages. The VID pins for the processor are CMOS outputs driven by the processor VID circuitry. [Table 2](#) specifies the voltage level corresponding to the state of VID[6:0]. A 1 in this refers to a high-voltage level and a 0 refers to low-voltage level.

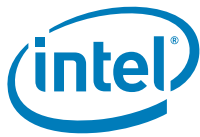
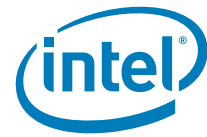

Table 2. Voltage Identification Definition (Sheet 1 of 4)

VID6	VID5	VID4	VID3	VID2	VID1	VID0	V <sub>CC</sub> (V)
0	0	0	0	0	0	0	1.5000
0	0	0	0	0	0	1	1.4875
0	0	0	0	0	1	0	1.4750
0	0	0	0	0	1	1	1.4625
0	0	0	0	1	0	0	1.4500
0	0	0	0	1	0	1	1.4375
0	0	0	0	1	1	0	1.4250
0	0	0	0	1	1	1	1.4125
0	0	0	1	0	0	0	1.4000
0	0	0	1	0	0	1	1.3875
0	0	0	1	0	1	0	1.3750
0	0	0	1	0	1	1	1.3625
0	0	0	1	1	0	0	1.3500
0	0	0	1	1	0	1	1.3375
0	0	0	1	1	1	0	1.3250
0	0	0	1	1	1	1	1.3125
0	0	1	0	0	0	0	1.3000
0	0	1	0	0	0	1	1.2875
0	0	1	0	0	1	0	1.2750
0	0	1	0	0	1	1	1.2625
0	0	1	0	1	0	0	1.2500
0	0	1	0	1	0	1	1.2375
0	0	1	0	1	1	0	1.2250
0	0	1	0	1	1	1	1.2125
0	0	1	1	0	0	0	1.2000
0	0	1	1	0	0	1	1.1875
0	0	1	1	0	1	0	1.1750
0	0	1	1	0	1	1	1.1625
0	0	1	1	1	0	0	1.1500
0	0	1	1	1	0	1	1.1375
0	0	1	1	1	1	0	1.1250
0	0	1	1	1	1	1	1.1125
0	1	0	0	0	0	0	1.1000
0	1	0	0	0	0	1	1.0875
0	1	0	0	0	1	0	1.0750
0	1	0	0	0	1	1	1.0625
0	1	0	0	1	0	0	1.0500



**Table 2. Voltage Identification Definition (Sheet 2 of 4)**

VID6	VID5	VID4	VID3	VID2	VID1	VID0	V <sub>CC</sub> (V)
0	1	0	0	1	0	1	1.0375
0	1	0	0	1	1	0	1.0250
0	1	0	0	1	1	1	1.0125
0	1	0	1	0	0	0	1.0000
0	1	0	1	0	0	1	0.9875
0	1	0	1	0	1	0	0.9750
0	1	0	1	0	1	1	0.9625
0	1	0	1	1	0	0	0.9500
0	1	0	1	1	0	1	0.9375
0	1	0	1	1	1	0	0.9250
0	1	0	1	1	1	1	0.9125
0	1	1	0	0	0	0	0.9000
0	1	1	0	0	0	1	0.8875
0	1	1	0	0	1	0	0.8750
0	1	1	0	0	1	1	0.8625
0	1	1	0	1	0	0	0.8500
0	1	1	0	1	0	1	0.8375
0	1	1	0	1	1	0	0.8250
0	1	1	0	1	1	1	0.8125
0	1	1	1	0	0	0	0.8000
0	1	1	1	0	0	1	0.7875
0	1	1	1	0	1	0	0.7750
0	1	1	1	0	1	1	0.7625
0	1	1	1	1	0	0	0.7500
0	1	1	1	1	0	1	0.7375
0	1	1	1	1	1	0	0.7250
0	1	1	1	1	1	1	0.7125
1	0	0	0	0	0	0	0.7000
1	0	0	0	0	0	1	0.6875
1	0	0	0	0	1	0	0.6750
1	0	0	0	0	1	1	0.6625
1	0	0	0	1	0	0	0.6500
1	0	0	0	1	0	1	0.6375
1	0	0	0	1	1	0	0.6250
1	0	0	0	1	1	1	0.6125
1	0	0	1	0	0	0	0.6000
1	0	0	1	0	0	1	0.5875
1	0	0	1	0	1	0	0.5750



Table 2. Voltage Identification Definition (Sheet 3 of 4)

VID6	VID5	VID4	VID3	VID2	VID1	VID0	V <sub>CC</sub> (V)
1	0	0	1	0	1	1	0.5625
1	0	0	1	1	0	0	0.5500
1	0	0	1	1	0	1	0.5375
1	0	0	1	1	1	0	0.5250
1	0	0	1	1	1	1	0.5125
1	0	1	0	0	0	0	0.5000
1	0	1	0	0	0	1	0.4875
1	0	1	0	0	1	0	0.4750
1	0	1	0	0	1	1	0.4625
1	0	1	0	1	0	0	0.4500
1	0	1	0	1	0	1	0.4375
1	0	1	0	1	1	0	0.4250
1	0	1	0	1	1	1	0.4125
1	0	1	1	0	0	0	0.4000
1	0	1	1	0	0	1	0.3875
1	0	1	1	0	1	0	0.3750
1	0	1	1	0	1	1	0.3625
1	0	1	1	1	0	0	0.3500
1	0	1	1	1	0	1	0.3375
1	0	1	1	1	1	0	0.3250
1	0	1	1	1	1	1	0.3125
1	1	0	0	0	0	0	0.3000
1	1	0	0	0	0	1	0.2875
1	1	0	0	0	1	0	0.2750
1	1	0	0	0	1	1	0.2625
1	1	0	0	1	0	0	0.2500
1	1	0	0	1	0	1	0.2375
1	1	0	0	1	1	0	0.2250
1	1	0	0	1	1	1	0.2125
1	1	0	1	0	0	0	0.2000
1	1	0	1	0	0	1	0.1875
1	1	0	1	0	1	0	0.1750
1	1	0	1	0	1	1	0.1625
1	1	0	1	1	0	0	0.1500
1	1	0	1	1	0	1	0.1375
1	1	0	1	1	1	0	0.1250
1	1	0	1	1	1	1	0.1125
1	1	1	0	0	0	0	0.1000



Table 2. Voltage Identification Definition (Sheet 4 of 4)

VID6	VID5	VID4	VID3	VID2	VID1	VID0	V <sub>CC</sub> (V)
1	1	1	0	0	0	1	0.0875
1	1	1	0	0	1	0	0.0750
1	1	1	0	0	1	1	0.0625
1	1	1	0	1	0	0	0.0500
1	1	1	0	1	0	1	0.0375
1	1	1	0	1	1	0	0.0250
1	1	1	0	1	1	1	0.0125
1	1	1	1	0	0	0	0.0000
1	1	1	1	0	0	1	0.0000
1	1	1	1	0	1	0	0.0000
1	1	1	1	0	1	1	0.0000
1	1	1	1	1	0	0	0.0000
1	1	1	1	1	0	1	0.0000
1	1	1	1	1	1	0	0.0000
1	1	1	1	1	1	1	0.0000

### 3.4 Catastrophic Thermal Protection

The processor supports the THERMTRIP# signal for catastrophic thermal protection. An external thermal sensor should also be used to protect the processor and the system against excessive temperatures. Even with the activation of THERMTRIP#, which halts all processor internal clocks and activity, leakage current can be high enough such that the processor cannot be protected in all conditions without the removal of power to the processor. If the external thermal sensor detects a catastrophic processor temperature of 125°C (maximum), or if the THERMTRIP# signal is asserted, the V<sub>CC</sub> supply to the processor must be turned off within 500 ms to prevent permanent silicon damage due to thermal runaway of the processor. THERMTRIP# functionality is not guaranteed if the PWRGOOD signal is not asserted.

### 3.5 Reserved and Unused Pins

All RESERVED (RSVD) pins must remain unconnected. Connection of these pins to V<sub>CC</sub>, V<sub>SS</sub>, or to any other signal (including each other) can result in component malfunction or incompatibility with future processors. See [Section 4.2](#) for a pin listing of the processor and the location of all RSVD pins.

For reliable operation, always connect unused inputs or bidirectional signals to an appropriate signal level. Unused active low AGTL+ inputs may be left as no connects if AGTL+ termination is provided on the processor silicon. Unused active high inputs should be connected through a resistor to ground (V<sub>SS</sub>). Unused outputs can be left unconnected.

The TEST1 and TEST2 pins must have a stuffing option of separate pull-down resistors to V<sub>SS</sub>.



For testing purposes, route the TEST3 and TEST5 signals through a ground referenced  $Z_0 = 55\text{-}\Omega$  trace that ends in a via that is near a GND via and is accessible through an oscilloscope connection.

### 3.6 FSB Frequency Select Signals (BSEL[2:0])

The BSEL[2:0] signals are used to select the frequency of the processor input clock (BCLK[1:0]). These signals should be connected to the clock chip and the chipset system on the platform. The BSEL encoding for BCLK[1:0] is shown in Table 3.

Table 3. BSEL[2:0] Encoding for BCLK Frequency

BSEL[2]	BSEL[1]	BSEL[0]	BCLK Frequency
L	L	L	RESERVED
L	L	H	133 MHz

### 3.7 FSB Signal Groups

In the following chapter, the FSB signals have been combined into groups by buffer type. AGTL+ input signals have differential input buffers, which use GTLREF as a reference level. The term AGTL+ Input refers to the AGTL+ input group as well as the AGTL+ I/O group when receiving. Similarly, AGTL+ Output refers to the AGTL+ output group as well as the AGTL+ I/O group when driving.

Two sets of timing parameters are specified because of a source synchronous data bus. One set is for common clock signals that are dependent upon the rising edge of BCLK0 (ADS#, HIT#, HITM#, etc.) and the second set is for the source synchronous signals that are relative to their respective strobe lines (data and address) as well as the rising edge of BCLK0.

Asynchronous signals are still present (A20M#, IGNNE#, etc.) and can become active at any time during the clock cycle. Table 4 identifies which signals are common clock, source synchronous, and asynchronous.

Table 4. FSB Pin Groups (Sheet 1 of 2)

Signal Group	Type	Signals <sup>1</sup>														
AGTL+ Common Clock Input	Synchronous to BCLK[1:0]	BPRI#, DEFER#, PREQ# <sup>5</sup> , RESET#, RS[2:0]#, DPWR#, TRDY#														
AGTL+ Common Clock I/O	Synchronous to BCLK[1:0]	ADS#, BNR#, BPM[3:0]# <sup>3</sup> , BRO#, DBSY#, DRDY#, HIT#, HITM#, LOCK#, PRDY# <sup>3</sup>														
AGTL+ Source Synchronous I/O	Synchronous to Associated Strobe	<table border="1"> <thead> <tr> <th>Signals</th> <th>Associated Strobe</th> </tr> </thead> <tbody> <tr> <td>REQ[4:0]#, A[16:3]#</td> <td>ADSTB[0]#</td> </tr> <tr> <td>A[35:17]#<sup>6</sup></td> <td>ADSTB[1]#</td> </tr> <tr> <td>D[15:0]#, DINVO#</td> <td>DSTBP0#, DSTBN0#</td> </tr> <tr> <td>D[31:16]#, DINV1#</td> <td>DSTBP1#, DSTBN1#</td> </tr> <tr> <td>D[47:32]#, DINV2#</td> <td>DSTBP2#, DSTBN2#</td> </tr> <tr> <td>D[63:48]#, DINV3#</td> <td>DSTBP3#, DSTBN3#</td> </tr> </tbody> </table>	Signals	Associated Strobe	REQ[4:0]#, A[16:3]#	ADSTB[0]#	A[35:17]# <sup>6</sup>	ADSTB[1]#	D[15:0]#, DINVO#	DSTBP0#, DSTBN0#	D[31:16]#, DINV1#	DSTBP1#, DSTBN1#	D[47:32]#, DINV2#	DSTBP2#, DSTBN2#	D[63:48]#, DINV3#	DSTBP3#, DSTBN3#
		Signals	Associated Strobe													
		REQ[4:0]#, A[16:3]#	ADSTB[0]#													
		A[35:17]# <sup>6</sup>	ADSTB[1]#													
		D[15:0]#, DINVO#	DSTBP0#, DSTBN0#													
		D[31:16]#, DINV1#	DSTBP1#, DSTBN1#													
		D[47:32]#, DINV2#	DSTBP2#, DSTBN2#													
D[63:48]#, DINV3#	DSTBP3#, DSTBN3#															



Table 4. FSB Pin Groups (Sheet 2 of 2)

Signal Group	Type	Signals <sup>1</sup>
AGTL+ Strobes	Synchronous to BCLK[1:0]	ADSTB[1:0]#, DSTBP[3:0]#, DSTBN[3:0]#
CMOS Input	Asynchronous	A20M#, DPRSTP#, DPSLP#, IGNNE#, INIT#, LINT0/INTR, LINT1/NMI, PWRGOOD, SMI#, SLP#, STPCLK#
Open Drain Output	Asynchronous	FERR#, IERR#, THERMTRIP#
Open Drain I/O	Asynchronous	PROCHOT# <sup>4</sup>
CMOS Output	Asynchronous	PSI#, VID[6:0], BSEL[2:0]
CMOS Input	Synchronous to TCK	TCK, TDI, TMS, TRST#
Open Drain Output	Synchronous to TCK	TDO
FSB Clock	Clock	BCLK[1:0]
Power/Other		COMP[3:0], DBR# <sup>2</sup> , GTLREF, RSVD, TEST2, TEST1, THERMDA, THERMDC, V <sub>CC</sub> , V <sub>CCA</sub> , V <sub>CCP</sub> , V <sub>CC_SENSE</sub> , V <sub>SS</sub> , V <sub>SS_SENSE</sub>

**NOTES:**

1. Refer to [Chapter 4](#) for signal descriptions and termination requirements.
2. In processor systems where there is no debug port implemented on the system board, these signals are used to support a debug port interposer. In systems with the debug port implemented on the system board, these signals are no connects.
3. BPM[2:1]# and PRDY# are AGTL+ output only signals.
4. PROCHOT# signal type is open drain output and CMOS input.
5. On die termination differs from other AGTL+ signals, please refer to your Platform Design Guidelines for up-to-date recommendations.
6. When paired with a chipset limited to 32-bit addressing, A[35:32] should remain unconnected.

## 3.8 CMOS Signals

CMOS input signals are shown in [Table 4](#). Legacy output FERR#, IERR# and other non-AGTL+ signals (THERMTRIP# and PROCHOT#) utilize Open Drain output buffers. These signals do not have setup or hold time specifications in relation to BCLK[1:0]. However, all of the CMOS signals are required to be asserted for at least three BCLKs in order for the processor to recognize them.

## 3.9 Maximum Ratings

[Table 5](#) specifies absolute maximum and minimum ratings. If the processor stays within the defined functional operation limits, functionality and long-term reliability can be expected.

**Caution:** At conditions exceeding absolute maximum and minimum ratings, neither functionality nor long-term reliability can be expected.

**Warning:** Precautions should always be taken to avoid high static voltages or electric fields.



**Table 5. Processor Absolute Maximum Ratings**

Symbol	Parameter	Min	Max	Unit	Notes <sup>1</sup>
T <sub>STORAGE</sub>	Processor storage temperature	-40	85	°C	2, 3, 4
V <sub>CC</sub>	Any processor supply voltage with respect to V <sub>SS</sub>	-0.3	1.55	V	
V <sub>inAGTL+</sub>	AGTL+ buffer DC input voltage with respect to V <sub>SS</sub>	-0.1	1.55	V	
V <sub>inAsynch_CMOS</sub>	CMOS buffer DC input voltage with respect to V <sub>SS</sub>	-0.1	1.55	V	

**NOTES:**

1. For functional operation, all processor electrical, signal quality, mechanical and thermal specifications must be met.
2. Storage temperature is applicable to storage conditions only. In this scenario, the processor must not receive a clock, and no lands can be connected to a voltage bias. Storage within these limits does not affect the long-term reliability of the device. For functional operation, please refer to the processor case temperature specifications.
3. This rating applies to the processor and does not include any tray or packaging.
4. Failure to adhere to this specification can affect the long term reliability of the processor.

### 3.10 Processor DC Specifications

The processor DC specifications in this section are defined at the processor core (pads) unless noted otherwise. See Table 4 for the pin signal definitions and signal pin assignments. Most of the signals on the FSB are in the AGTL+ signal group. The DC specifications for these signals are listed in Table 8. DC specifications for the CMOS group are listed in Table 9.

Table 6 through Table 10 list the DC specifications and are valid only while meeting specifications for junction temperature, clock frequency, and input voltages. Active mode load line specifications apply in all states except in the Deep Sleep state. V<sub>CC,BOOT</sub> is the default voltage driven by the voltage regulator at power up in order to set the VID values. Unless specified otherwise, all specifications are at T<sub>junction</sub> = 100°C. Care should be taken to read all notes associated with each parameter.

**Table 6. DC Voltage and Current Specifications**

Symbol	Parameter	Min	Typ	Max	Unit	Notes
V <sub>CC</sub>	V <sub>CC</sub> of the Processor Core	0.95	1.15	1.30	V	1, 2
V <sub>CC,BOOT</sub>	Default V <sub>CC</sub> Voltage for Initial Power Up		1.20		V	2, 8
V <sub>CCP</sub>	AGTL+ Termination Voltage	1.00	1.05	1.10	V	
V <sub>CCA</sub>	PLL Supply Voltage	1.425	1.5	1.575	V	
I <sub>CCDES</sub>	I <sub>CC</sub> for processors Recommended Design Targets:			36	A	5



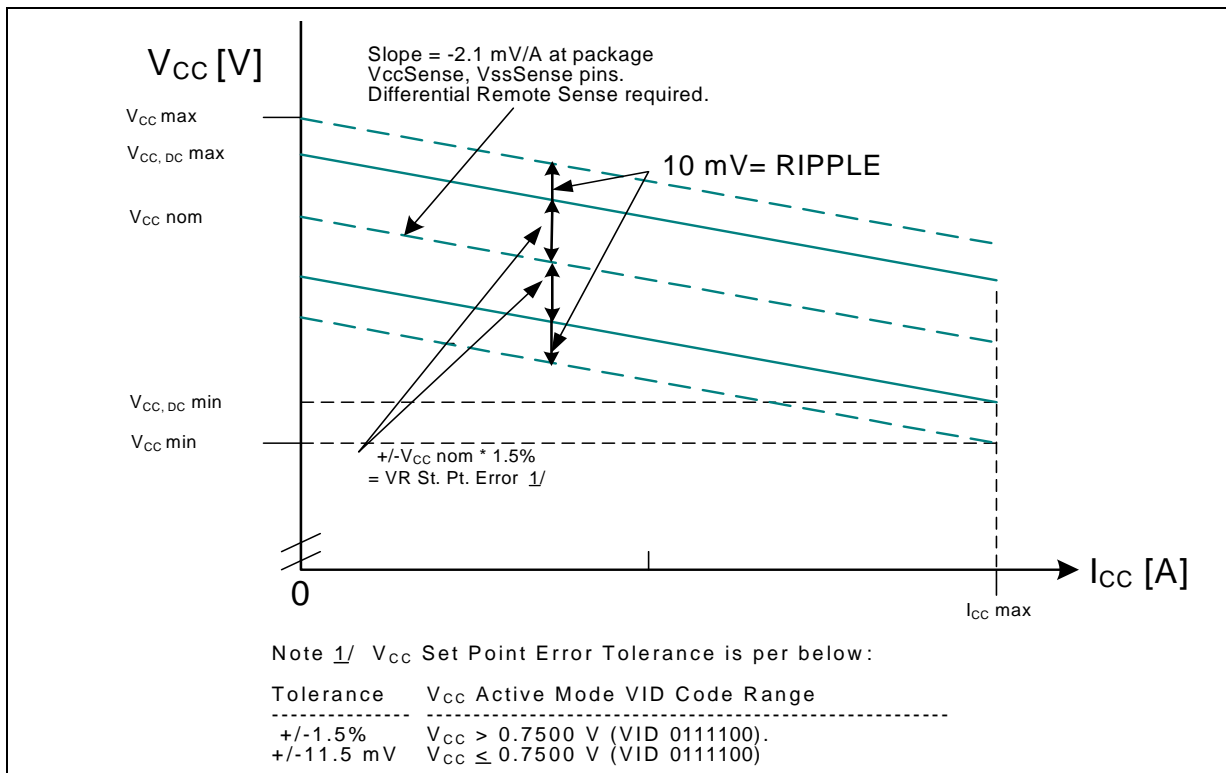

Table 6. DC Voltage and Current Specifications

Symbol	Parameter			Min	Typ	Max	Unit	Notes
I <sub>CC</sub>	I <sub>CC</sub> for processors						A	
	Processor Number	Frequency	Die Variant					
	530	1.73 GHz	1-M Fused 1 M			34.5 32.0		
	540	1.86 GHz	1-M Fused 1 M			34.5 32.0	A	3, 4
	550	2.00 GHz	1-M Fused 1 M			34.5 32.0		
	560	2.13 GHz	1-M Fused 1 M			34.5 32.0		
I <sub>AH</sub> , I <sub>SGNT</sub>	I <sub>CC</sub> Auto-Halt & Stop-Grant					21	A	3, 4
I <sub>SLP</sub>	I <sub>CC</sub> Sleep					20.5	A	3, 4
I <sub>DSL</sub>	I <sub>CC</sub> Deep Sleep					18.6	A	3, 4
dI <sub>CC</sub> /DT	V <sub>CC</sub> Power Supply Current Slew Rate at CPU Package Pin					600	A/μs	6, 7
I <sub>CCA</sub>	I <sub>CC</sub> for V <sub>CCA</sub> Supply					130	mA	
I <sub>CCP</sub>	I <sub>CC</sub> for V <sub>CCP</sub> Supply before V <sub>CC</sub> Stable					4.5	A	9
	I <sub>CC</sub> for V <sub>CCP</sub> Supply after V <sub>CC</sub> Stable					2.5	A	10

**NOTES:**

- Each processor is programmed with a maximum valid voltage identification value (VID), which is set at manufacturing and can not be altered. Individual maximum VID values are calibrated during manufacturing such that two processors at the same frequency may have different settings within the VID range.
- The voltage specifications are assumed to be measured across V<sub>CC\_SENSE</sub> and V<sub>SS\_SENSE</sub> pins at the socket with a 100-MHz bandwidth oscilloscope, 1.5-pF maximum probe capacitance, and 1-MΩ minimum impedance. The maximum length of ground wire on the probe should be less than 5 mm. Ensure external noise from the system is not coupled in the scope probe.
- Specified at 100°C T<sub>j</sub>.
- Specified at the VID voltage.
- The I<sub>CCDES</sub>(max) specification of 36-A comprehends only the processor.
- Based on simulations and averaged over the duration of any change in current. Specified by design/characterization at nominal V<sub>CC</sub>. Not 100% tested.
- Measured at the bulk capacitors on the motherboard.
- V<sub>CC\_BOOT</sub> tolerance shown in [Figure 3](#).
- This is a steady-state I<sub>CCP</sub> current specification, which is applicable when both V<sub>CCP</sub> and V<sub>CC\_CORE</sub> are high.
- This is a power-up peak current specification, which is applicable when V<sub>CCP</sub> is high and V<sub>CC\_CORE</sub> is low.

**Figure 3. Active  $V_{CC}$  and  $I_{CC}$  Loadline Standard Voltage**

**Table 7. FSB Differential BCLK Specifications**

Symbol	Parameter	Min	Typ	Max	Unit	Notes <sup>1</sup>
$V_{IH}$	Input High Voltage	0.660	0.710	0.85	V	
$V_{IL}$	Input Low Voltage		0		V	
$V_{CROSS}$	Crossing Voltage	0.25	0.35	0.55	V	2
$\Delta V_{CROSS}$	Range of Crossing Points			0.14	V	6
$V_{TH}$	Threshold Region	$V_{CROSS} - 0.100$		$V_{CROSS} + 0.100$	V	3
$I_{LI}$	Input Leakage Current			$\pm 100$	$\mu\text{A}$	4
CPAD	Pad Capacitance	0.95	1.2	1.45	pF	5

**NOTES:**

- Unless otherwise noted, all specifications in this table apply to all processor frequencies.
- Crossing Voltage is defined as absolute voltage where rising edge of BCLK0 is equal to the falling edge of BCLK1.
- Threshold Region is defined as a region entered about the crossing voltage in which the differential receiver switches. It includes input threshold hysteresis.
- For  $V_{in}$  between 0 V and  $V_{IH}$ .
- Cpad includes die capacitance only. No package parasitics are included.
- $\Delta V_{CROSS}$  is defined as the total variation of all crossing voltages as defined in note 2.



Table 8. AGTL+ Signal Group DC Specifications

Symbol	Parameter	Min	Typ	Max	Unit	Notes <sup>1</sup>
V <sub>CCP</sub>	I/O Voltage	1.00	1.05	1.10	V	
GTLREF	Reference Voltage		2/3 V <sub>CCP</sub>		V	6
R <sub>COMP</sub>	Compensation Resistor	27.23	27.5	27.78	Ω	10
R <sub>ODT</sub>	Termination Resistor		55		Ω	11
V <sub>IH</sub>	Input High Voltage	GTLREF+0.10	V <sub>CCP</sub>	V <sub>CCP</sub> +0.10	V	2, 6
V <sub>IL</sub>	Input Low Voltage	-0.10	0	GTLREF-0.10	V	3, 4
V <sub>OH</sub>	Output High Voltage	V <sub>CCP</sub> -0.10	V <sub>CCP</sub>	V <sub>CCP</sub>		6
R <sub>TT</sub>	Termination Resistance	50	55	61	Ω	7
R <sub>ON</sub>	Buffer On Resistance	22	25	28	Ω	5
I <sub>LI</sub>	Input Leakage Current			±100	μA	8
C <sub>PAD</sub>	Pad Capacitance	1.6	2.1	2.55	pF	9

**NOTES:**

- Unless otherwise noted, all specifications in this table apply to all processor frequencies.
- V<sub>IH</sub> is defined as the minimum voltage level at a receiving agent that interprets as a logical high value.
- V<sub>IL</sub> is defined as the maximum voltage level at a receiving agent that interprets as a logical low value.
- V<sub>IH</sub> and V<sub>OH</sub> may experience excursions above V<sub>CCP</sub>. However, input signal drivers must comply with the signal quality specifications.
- This is the pull-down driver resistance. Refer to processor I/O Buffer Models for I/V characteristics. Measured at 0.31\*V<sub>CCP</sub>. R<sub>ON</sub> (min) = 0.38\*R<sub>TT</sub>. R<sub>ON</sub> (typ) = 0.45\*R<sub>TT</sub>. R<sub>ON</sub> (max) = 0.52\*R<sub>TT</sub>.
- GTLREF should be generated from V<sub>CCP</sub> with a 1% tolerance resistor divider. The V<sub>CCP</sub> referred to in these specifications is the instantaneous V<sub>CCP</sub>.
- R<sub>TT</sub> is the on-die termination resistance measured at V<sub>OL</sub> of the AGTL+ output driver. Measured at 0.31\*V<sub>CCP</sub>. R<sub>TT</sub> is connected to V<sub>CCP</sub> on die. Refer to processor I/O buffer models for I/V characteristics.
- Specified with on die R<sub>TT</sub> and R<sub>ON</sub> are turned off. Vin between 0 and V<sub>CCP</sub>.
- Cpad includes die capacitance only. No package parasitics are included.
- This is the external resistor on the comp pins.
- On die termination resistance, measured at 0.33\*V<sub>CCP</sub>.



**Table 9. CMOS Signal Group DC Specifications**

Symbol	Parameter	Min	Typ	Max	Unit	Notes <sup>1</sup>
V <sub>CCP</sub>	I/O Voltage	1.00	1.05	1.10	V	
V <sub>IH</sub>	Input High Voltage	0.7*V <sub>CCP</sub>	V <sub>CCP</sub>	V <sub>CCP</sub> +0.1	V	2
V <sub>IL</sub>	Input Low Voltage CMOS	-0.10	0.00	0.3*V <sub>CCP</sub>	V	2, 3
V <sub>OH</sub>	Output High Voltage	0.9*V <sub>CCP</sub>	V <sub>CCP</sub>	V <sub>CCP</sub> +0.1	V	2
V <sub>OL</sub>	Output Low Voltage	-0.10	0	0.1*V <sub>CCP</sub>	V	2
I <sub>OH</sub>	Output High Current	1.5		4.1	mA	5
I <sub>OL</sub>	Output Low Current	1.5		4.1	mA	4
I <sub>LI</sub>	Input Leakage Current			±100	µA	6
C <sub>PAD1</sub>	Pad Capacitance	1.6	2.1	2.55	pF	7
C <sub>PAD2</sub>	Pad Capacitance for CMOS Input	0.95	1.2	1.45		8

**NOTES:**

1. Unless otherwise noted, all specifications in this table apply to all processor frequencies.
2. The V<sub>CCP</sub> referred to in these specifications refers to instantaneous V<sub>CCP</sub>.
3. Refer to the processor I/O Buffer Models for I/V characteristics.
4. Measured at 0.1\*V<sub>CCP</sub>.
5. Measured at 0.9\*V<sub>CCP</sub>.
6. For Vin between 0 V and V<sub>CCP</sub>. Measured when the driver is tristated.
7. C<sub>PAD1</sub> includes die capacitance only for DPRSTP#, DPSLP#, PWRGOOD. No package parasitics are included.
8. C<sub>PAD2</sub> includes die capacitance for all other CMOS input signals. No package parasitics are included.

**Table 10. Open Drain Signal Group DC Specifications**

Symbol	Parameter	Min	Typ	Max	Unit	Notes <sup>1</sup>
V <sub>OH</sub>	Output High Voltage	V <sub>CCP</sub> - 5%	V <sub>CCP</sub>	V <sub>CCP</sub> + 5%	V	3
V <sub>OL</sub>	Output Low Voltage	0		0.20	V	
I <sub>OL</sub>	Output Low Current	16		50	mA	2
I <sub>LO</sub>	Output Leakage Current			±200	µA	4
C <sub>PAD</sub>	Pad Capacitance	1.9	2.2	2.45	pF	5

**NOTES:**

1. Unless otherwise noted, all specifications in this table apply to all processor frequencies.
2. Measured at 0.2 V.
3. V<sub>OH</sub> is determined by value of the external pull-up resistor to V<sub>CCP</sub>. Please refer to platform design guide for details.
4. For Vin between 0 V and V<sub>OH</sub>.
5. C<sub>PAD</sub> includes die capacitance only. No package parasitics are included.

§



## **4** *Package Mechanical Specifications and Pin Information*

---

### **4.1** **Package Mechanical Specifications**

The processor has two variants, both available in a 478-pin Micro-FCPGA package. Package mechanical dimensions are shown in [Figure 4](#) for the 1-MB fused variant and [Figure 6](#) for the 1-MB variant.

Figure 4. 1-MB Fused Micro-FCPGA Processor Package Drawing (1 of 2)

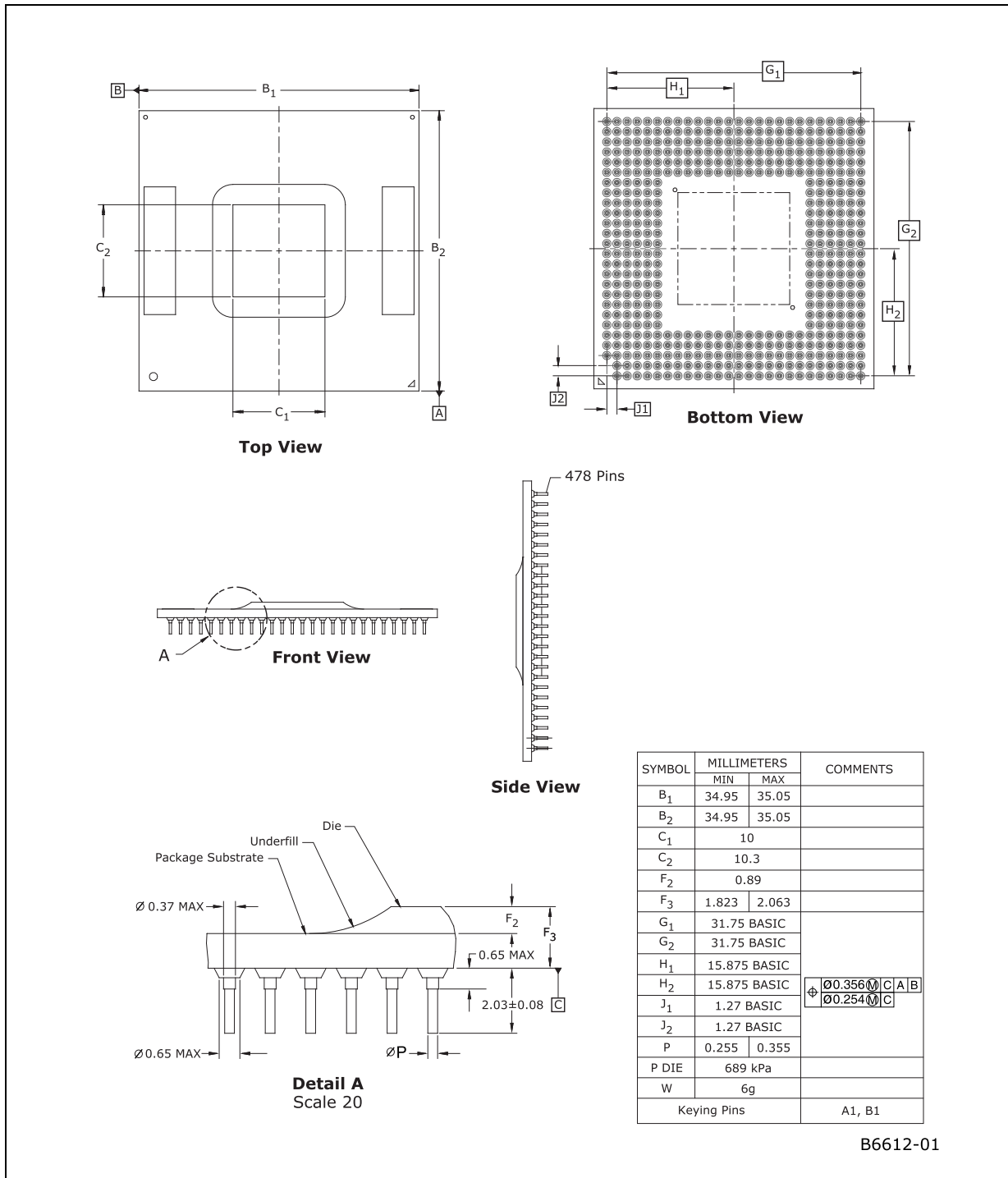
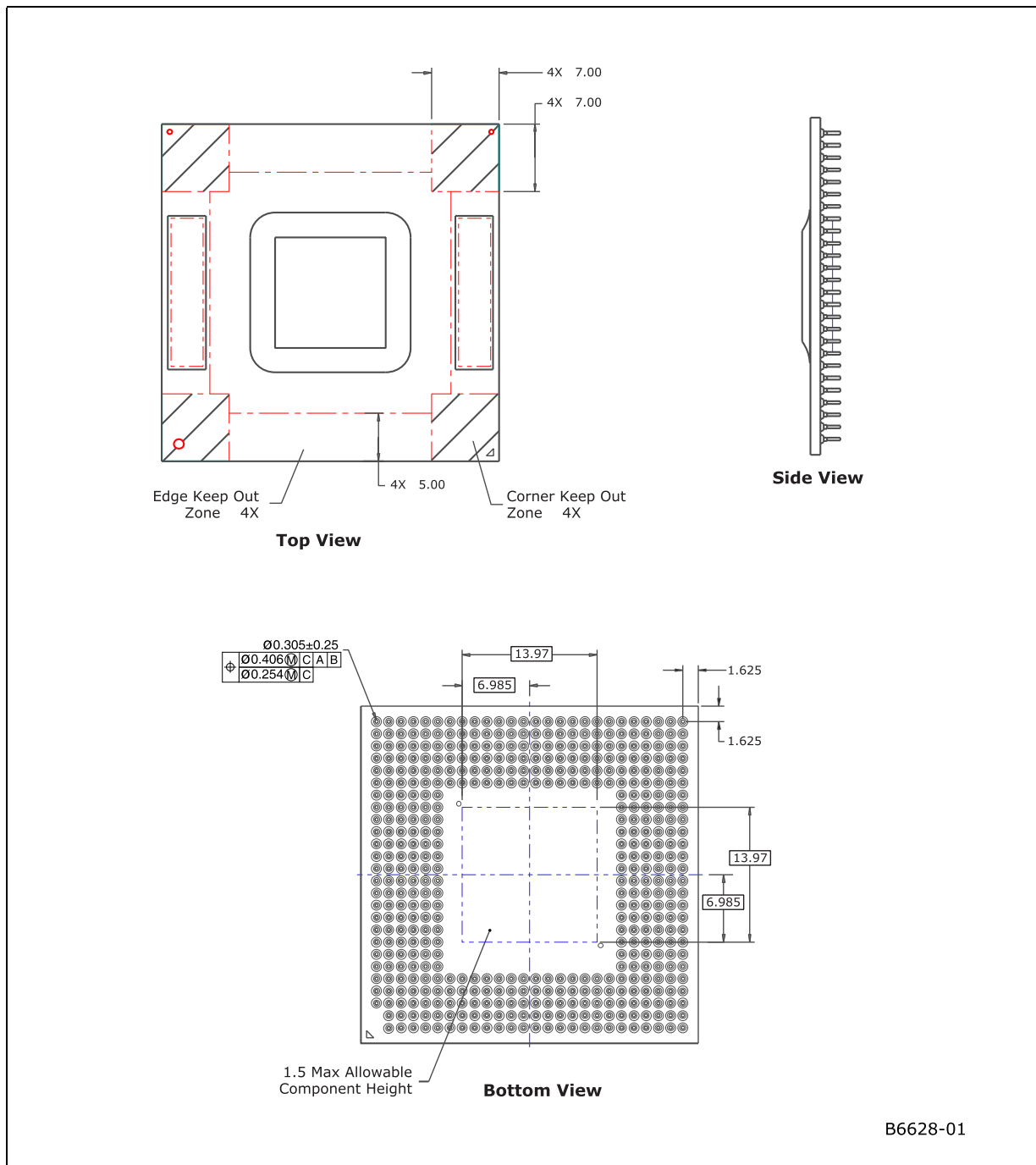



Figure 5. 1-MB Fused Micro-FCPGA Processor Package Drawing (2 of 2)



B6628-01

Figure 6. 1-MB Micro-FCPGA Processor Package Drawing (1 of 2)

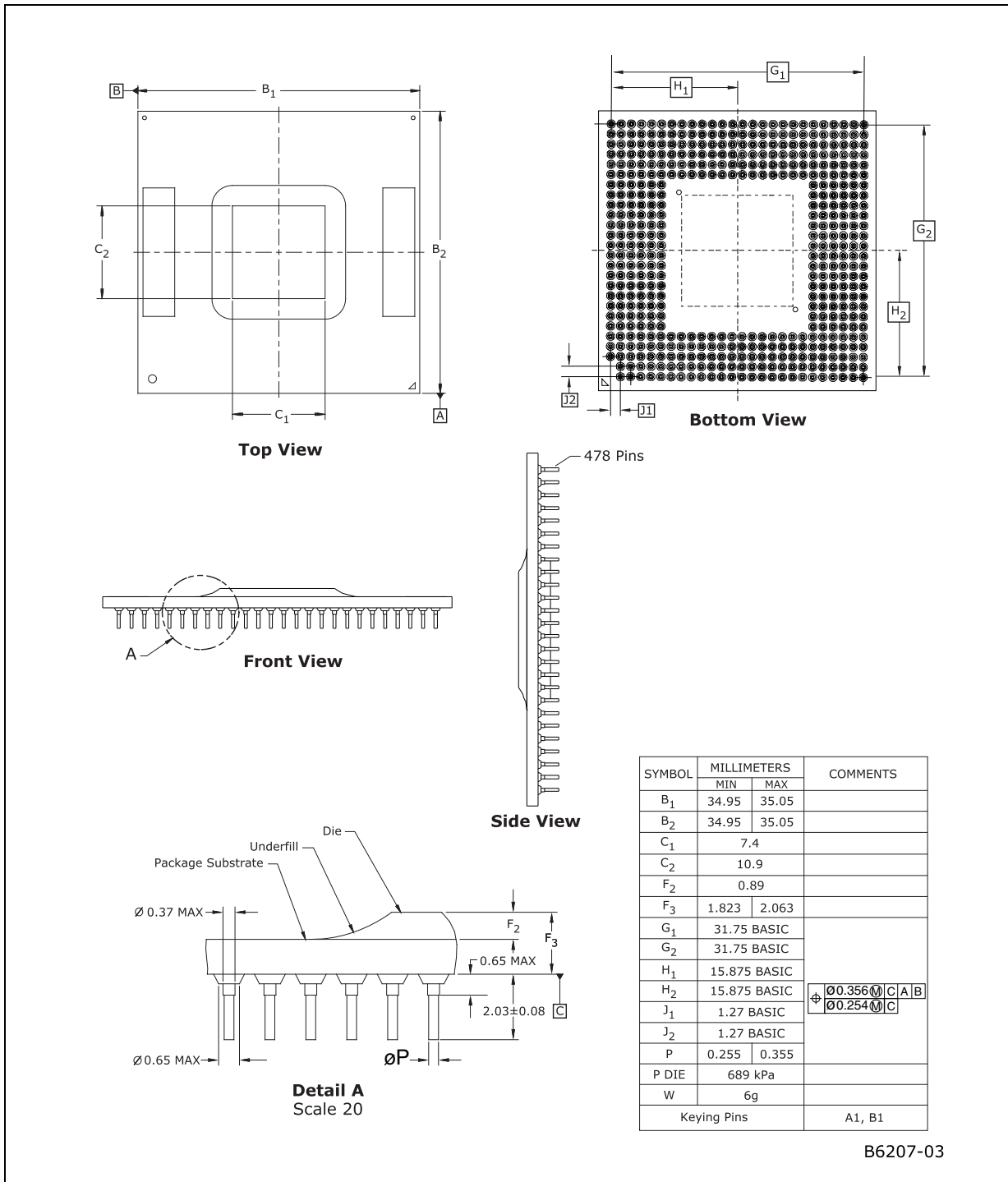
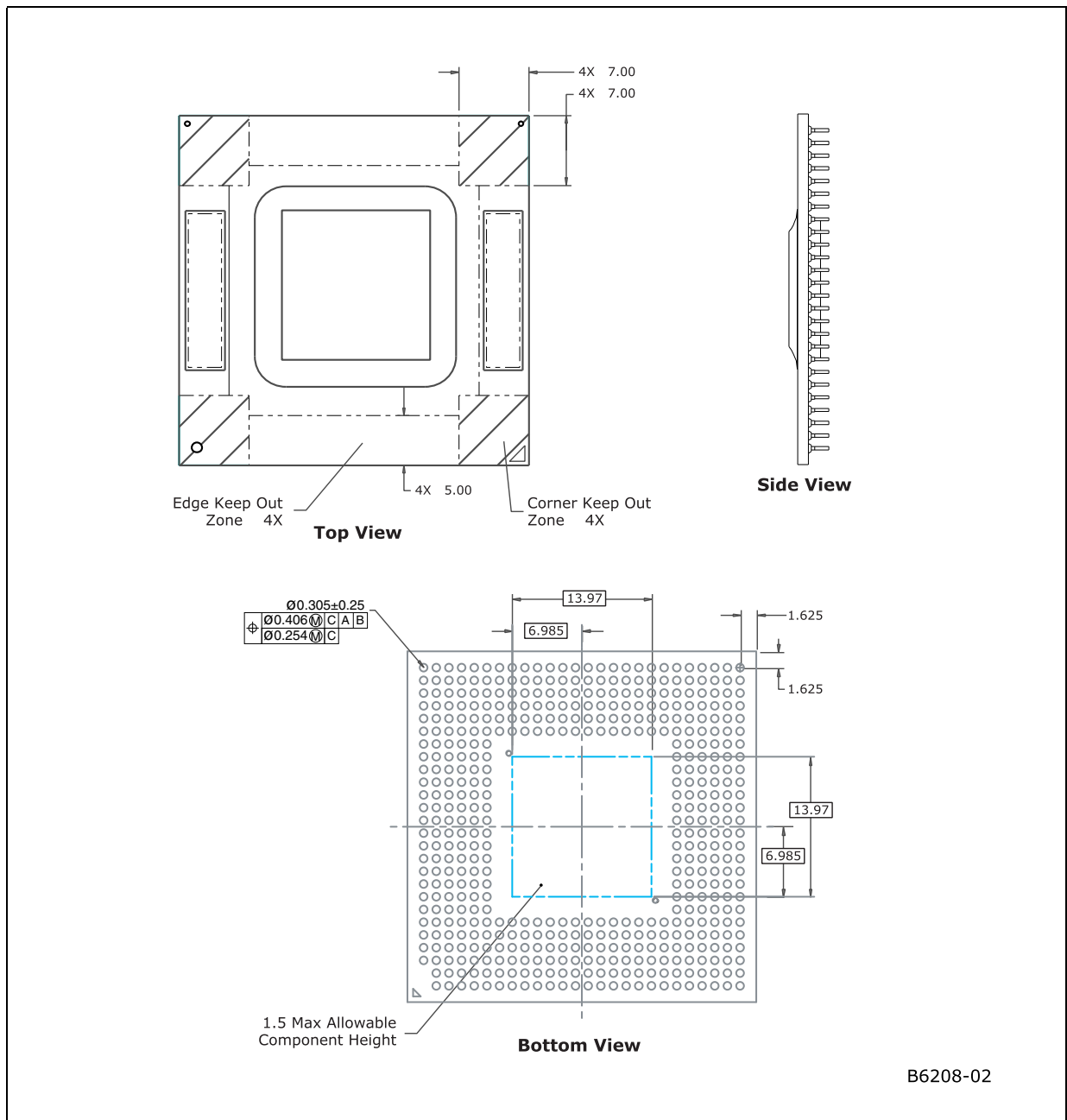

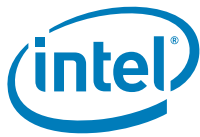



Figure 7. 1-MB Micro-FCPGA Processor Package Drawing (2 of 2)



B6208-02



## 4.2 Processor Pinout and Pin List

Table 11 shows the top view pinout of the processor.

**Table 11. The Coordinates of the Processor Pins as Viewed from the Top of the Package (Sheet 1 of 2)**

	1	2	3	4	5	6	7	8	9	10	11	12	13	
A		VSS	SMI#	VSS	FERR#	A20M#	VCC	VSS	VCC	VCC	VSS	VCC	VCC	A
B		RSVD	INIT#	LINT1	DPSLP#	VSS	VCC	VSS	VCC	VCC	VSS	VCC	VSS	B
C	RESET#	VSS	RSVD	IGNNE#	VSS	LINT0	THERM TRIP#	VSS	VCC	VCC	VSS	VCC	VCC	C
D	VSS	RSVD	RSVD	VSS	STPCLK#	PWRGOD	SLP#	VSS	VCC	VCC	VSS	VCC	VSS	D
E	DBSY#	BNR#	VSS	HITM#	DPRSTP#	VSS	VCC	VSS	VCC	VCC	VSS	VCC	VCC	E
F	BR0#	VSS	RS[0]#	RS[1]#	VSS	RSVD	VCC	VSS	VCC	VCC	VSS	VCC	VSS	F
G	VSS	TRDY#	RS[2]#	VSS	BPRI#	HIT#							G	
H	ADS#	REQ[1]#	VSS	LOCK#	DEFER#	VSS							H	
J	A[9]#	VSS	REQ[3]#	A[3]#	VSS	VCCP							J	
K	VSS	REQ[2]#	REQ[0]#	VSS	A[6]#	VCCP							K	
L	REQ[4]#	A[13]#	VSS	A[5]#	A[4]#	VSS							L	
M	ADSTB[0]#	VSS	A[7]#	RSVD	VSS	VCCP							M	
N	VSS	A[8]#	A[10]#	VSS	RSVD	VCCP							N	
P	A[15]#	A[12]#	VSS	A[14]#	A[11]#	VSS							P	
R	A[16]#	VSS	A[19]#	A[24]#	VSS	VCCP							R	
T	VSS	RSVD	A[26]#	VSS	A[25]#	VCCP							T	
U	A[23]#	A[30]#	VSS	A[21]#	A[18]#	VSS	U							
V	ADSTB[1]#	VSS	RSVD	A[31]#	VSS	VCCP	V							
W	VSS	A[27]#	A[32]#	VSS	A[28]#	A[20]#	W							
Y	COMP[3]	A[17]#	VSS	A[29]#	A[22]#	VSS	Y							
AA	COMP[2]	VSS	A[35]#	A[33]#	VSS	TDI	VCC	VSS	VCC	VCC	VSS	VCC	VCC	AA
AB	VSS	A[34]#	TDO	VSS	TMS	TRST#	VCC	VSS	VCC	VCC	VSS	VCC	VSS	AB
AC	PREQ#	PRDY#	VSS	BPM[3]#	TCK	VSS	VCC	VSS	VCC	VCC	VSS	VCC	VCC	AC
AD	BPM[2]#	VSS	BPM[1]#	BPM[0]#	VSS	VID[0]	VCC	VSS	VCC	VCC	VSS	VCC	VSS	AD
AE	VSS	VID[6]	VID[4]	VSS	VID[2]	PSI#	VSS SENSE	VSS	VCC	VCC	VSS	VCC	VCC	AE
AF	TEST5	VSS	VID[5]	VID[3]	VID[1]	VSS	VCC SENSE	VSS	VCC	VCC	VSS	VCC	VSS	AF



**Table 12. The Coordinates of the Processor Pins as Viewed from the Top of the Package (Sheet 2 of 2)**

	14	15	16	17	18	19	20	21	22	23	24	25	26	
A	VSS	VCC	VSS	VCC	VCC	VSS	VCC	BCLK[1]	BCLK[0]	VSS	THRMDA	VSS	TEST6	A
B	VCC	VCC	VSS	VCC	VCC	VSS	VCC	VSS	BSEL[0]	BSEL[1]	VSS	THRMDC	VCCA	B
C	VSS	VCC	VSS	VCC	VCC	VSS	DBR#	BSEL[2]	VSS	TEST1	TEST3	VSS	VCCA	C
D	VCC	VCC	VSS	VCC	VCC	VSS	IERR#	PROCHOT#	RSVD	VSS	DPWR#	TEST2	VSS	D
E	VSS	VCC	VSS	VCC	VCC	VSS	VCC	VSS	D[0]#	D[7]#	VSS	D[6]#	D[2]#	E
F	VCC	VCC	VSS	VCC	VCC	VSS	VCC	DRDY#	VSS	D[4]#	D[1]#	VSS	D[13]#	F
G								VCCP	D[3]#	VSS	D[9]#	D[5]#	VSS	G
H								VSS	D[12]#	D[15]#	VSS	DINV[0]#	DSTBP[0]#	H
J								VCCP	VSS	D[11]#	D[10]#	VSS	DSTBN[0]#	J
K								VCCP	D[14]#	VSS	D[8]#	D[17]#	VSS	K
L								VSS	D[22]#	D[20]#	VSS	D[29]#	DSTBN[1]#	L
M								VCCP	VSS	D[23]#	D[21]#	VSS	DSTBP[1]#	M
N								VCCP	D[16]#	VSS	DINV[1]#	D[31]#	VSS	N
P								VSS	D[26]#	D[25]#	VSS	D[24]#	D[18]#	P
R								VCCP	VSS	D[19]#	D[28]#	VSS	COMP[0]	R
T								VCCP	D[37]#	VSS	D[27]#	D[30]#	VSS	T
U								VSS	DINV[2]#	D[39]#	VSS	D[38]#	COMP[1]	U
V								VCCP	VSS	D[36]#	D[34]#	VSS	D[35]#	V
W								VCCP	D[41]#	VSS	D[43]#	D[44]#	VSS	W
Y	VSS	D[32]#	D[42]#	VSS	D[40]#	DSTBN[2]#	Y							
AA	VSS	VCC	VSS	VCC	VCC	VSS	VCC	D[50]#	VSS	D[45]#	D[46]#	VSS	DSTBP[2]#	AA
AB	VCC	VCC	VSS	VCC	VCC	VSS	VCC	D[52]#	D[51]#	VSS	D[33]#	D[47]#	VSS	AB
AC	VSS	VCC	VSS	VCC	VCC	VSS	DINV[3]#	VSS	D[60]#	D[63]#	VSS	D[57]#	D[53]#	AC
AD	VCC	VCC	VSS	VCC	VCC	VSS	D[54]#	D[59]#	VSS	D[61]#	D[49]#	VSS	GTLREF	AD
AE	VSS	VCC	VSS	VCC	VCC	VSS	VCC	D[58]#	D[55]#	VSS	D[48]#	DSTBN[3]#	VSS	AE
AF	VCC	VCC	VSS	VCC	VCC	VSS	VCC	VSS	D[62]#	D[56]#	DSTBP[3]#	VSS	TEST4	AF

§



This page is intentionally left blank.



**Table 13. Pin Listing by Pin Name (Sheet 1 of 15)**

Pin Name	Pin Number	Signal Buffer Type	Direction
A[3]#	J4	Source Synch	Input/Output
A[4]#	L5	Source Synch	Input/Output
A[5]#	L4	Source Synch	Input/Output
A[6]#	K5	Source Synch	Input/Output
A[7]#	M3	Source Synch	Input/Output
A[8]#	N2	Source Synch	Input/Output
A[9]#	J1	Source Synch	Input/Output
A[10]#	N3	Source Synch	Input/Output
A[11]#	P5	Source Synch	Input/Output
A[12]#	P2	Source Synch	Input/Output
A[13]#	L2	Source Synch	Input/Output
A[14]#	P4	Source Synch	Input/Output
A[15]#	P1	Source Synch	Input/Output
A[16]#	R1	Source Synch	Input/Output
A[17]#	Y2	Source Synch	Input/Output
A[18]#	U5	Source Synch	Input/Output
A[19]#	R3	Source Synch	Input/Output
A[20]#	W6	Source Synch	Input/Output
A[21]#	U4	Source Synch	Input/Output
A[22]#	Y5	Source Synch	Input/Output
A[23]#	U1	Source Synch	Input/Output
A[24]#	R4	Source Synch	Input/Output
A[25]#	T5	Source Synch	Input/Output
A[26]#	T3	Source Synch	Input/Output

**Table 13. Pin Listing by Pin Name (Sheet 2 of 15)**

Pin Name	Pin Number	Signal Buffer Type	Direction
A[27]#	W2	Source Synch	Input/Output
A[28]#	W5	Source Synch	Input/Output
A[29]#	Y4	Source Synch	Input/Output
A[30]#	U2	Source Synch	Input/Output
A[31]#	V4	Source Synch	Input/Output
A[32]#	W3	Source Synch	Input/Output
A[33]#	AA4	Source Synch	Input/Output
A[34]#	AB2	Source Synch	Input/Output
A[35]#	AA3	Source Synch	Input/Output
A20M#	A6	CMOS	Input
ADS#	H1	Common Clock	Input/Output
ADSTB[0]#	M1	Source Synch	Input/Output
ADSTB[1]#	V1	Source Synch	Input/Output
BCLK[0]	A22	Bus Clock	Input
BCLK[1]	A21	Bus Clock	Input
BNR#	E2	Common Clock	Input/Output
BPM[0]#	AD4	Common Clock	Input/Output
BPM[1]#	AD3	Common Clock	Output
BPM[2]#	AD1	Common Clock	Output
BPM[3]#	AC4	Common Clock	Input/Output
BPRI#	G5	Common Clock	Input
BR0#	F1	Common Clock	Input/Output
BSEL[0]	B22	CMOS	Output
BSEL[1]	B23	CMOS	Output
BSEL[2]	C21	CMOS	Output
COMP[0]	R26	Power/Other	Input/Output
COMP[1]	U26	Power/Other	Input/Output
COMP[2]	AA1	Power/Other	Input/Output



**Table 13. Pin Listing by Pin Name (Sheet 3 of 15)**

Pin Name	Pin Number	Signal Buffer Type	Direction
COMP[3]	Y1	Power/Other	Input/Output
D[0]#	E22	Source Synch	Input/Output
D[1]#	F24	Source Synch	Input/Output
D[2]#	E26	Source Synch	Input/Output
D[3]#	G22	Source Synch	Input/Output
D[4]#	F23	Source Synch	Input/Output
D[5]#	G25	Source Synch	Input/Output
D[6]#	E25	Source Synch	Input/Output
D[7]#	E23	Source Synch	Input/Output
D[8]#	K24	Source Synch	Input/Output
D[9]#	G24	Source Synch	Input/Output
D[10]#	J24	Source Synch	Input/Output
D[11]#	J23	Source Synch	Input/Output
D[12]#	H22	Source Synch	Input/Output
D[13]#	F26	Source Synch	Input/Output
D[14]#	K22	Source Synch	Input/Output
D[15]#	H23	Source Synch	Input/Output
D[16]#	N22	Source Synch	Input/Output
D[17]#	K25	Source Synch	Input/Output
D[18]#	P26	Source Synch	Input/Output
D[19]#	R23	Source Synch	Input/Output
D[20]#	L23	Source Synch	Input/Output
D[21]#	M24	Source Synch	Input/Output
D[22]#	L22	Source Synch	Input/Output
D[23]#	M23	Source Synch	Input/Output

**Table 13. Pin Listing by Pin Name (Sheet 4 of 15)**

Pin Name	Pin Number	Signal Buffer Type	Direction
D[24]#	P25	Source Synch	Input/Output
D[25]#	P23	Source Synch	Input/Output
D[26]#	P22	Source Synch	Input/Output
D[27]#	T24	Source Synch	Input/Output
D[28]#	R24	Source Synch	Input/Output
D[29]#	L25	Source Synch	Input/Output
D[30]#	T25	Source Synch	Input/Output
D[31]#	N25	Source Synch	Input/Output
D[32]#	Y22	Source Synch	Input/Output
D[33]#	AB24	Source Synch	Input/Output
D[34]#	V24	Source Synch	Input/Output
D[35]#	V26	Source Synch	Input/Output
D[36]#	V23	Source Synch	Input/Output
D[37]#	T22	Source Synch	Input/Output
D[38]#	U25	Source Synch	Input/Output
D[39]#	U23	Source Synch	Input/Output
D[40]#	Y25	Source Synch	Input/Output
D[41]#	W22	Source Synch	Input/Output
D[42]#	Y23	Source Synch	Input/Output
D[43]#	W24	Source Synch	Input/Output
D[44]#	W25	Source Synch	Input/Output
D[45]#	AA23	Source Synch	Input/Output
D[46]#	AA24	Source Synch	Input/Output
D[47]#	AB25	Source Synch	Input/Output
D[48]#	AE24	Source Synch	Input/Output



**Table 13. Pin Listing by Pin Name (Sheet 5 of 15)**

Pin Name	Pin Number	Signal Buffer Type	Direction
D[49]#	AD24	Source Synch	Input/Output
D[50]#	AA21	Source Synch	Input/Output
D[51]#	AB22	Source Synch	Input/Output
D[52]#	AB21	Source Synch	Input/Output
D[53]#	AC26	Source Synch	Input/Output
D[54]#	AD20	Source Synch	Input/Output
D[55]#	AE22	Source Synch	Input/Output
D[56]#	AF23	Source Synch	Input/Output
D[57]#	AC25	Source Synch	Input/Output
D[58]#	AE21	Source Synch	Input/Output
D[59]#	AD21	Source Synch	Input/Output
D[60]#	AC22	Source Synch	Input/Output
D[61]#	AD23	Source Synch	Input/Output
D[62]#	AF22	Source Synch	Input/Output
D[63]#	AC23	Source Synch	Input/Output
DBR#	C20	CMOS	Output
DBSY#	E1	Common Clock	Input/Output
DEFER#	H5	Common Clock	Input
DINV[0]#	H25	Source Synch	Input/Output
DINV[1]#	N24	Source Synch	Input/Output
DINV[2]#	U22	Source Synch	Input/Output
DINV[3]#	AC20	Source Synch	Input/Output
DPRSTP#	E5	CMOS	Input
DPSLP#	B5	CMOS	Input
DPWR#	D24	Common Clock	Input/Output
DRDY#	F21	Common Clock	Input/Output

**Table 13. Pin Listing by Pin Name (Sheet 6 of 15)**

Pin Name	Pin Number	Signal Buffer Type	Direction
DSTBN[0]#	J26	Source Synch	Input/Output
DSTBN[1]#	L26	Source Synch	Input/Output
DSTBN[2]#	Y26	Source Synch	Input/Output
DSTBN[3]#	AE25	Source Synch	Input/Output
DSTBP[0]#	H26	Source Synch	Input/Output
DSTBP[1]#	M26	Source Synch	Input/Output
DSTBP[2]#	AA26	Source Synch	Input/Output
DSTBP[3]#	AF24	Source Synch	Input/Output
FERR#	A5	Open Drain	Output
GTLREF	AD26	Power/Other	Input
HIT#	G6	Common Clock	Input/Output
HITM#	E4	Common Clock	Input/Output
IERR#	D20	Open Drain	Output
IGNNE#	C4	CMOS	Input
INIT#	B3	CMOS	Input
LINT0	C6	CMOS	Input
LINT1	B4	CMOS	Input
LOCK#	H4	Common Clock	Input/Output
PRDY#	AC2	Common Clock	Output
PREQ#	AC1	Common Clock	Input
PROCHOT#	D21	Open Drain	Input/Output
PSI#	AE6	CMOS	Output
PWRGOOD	D6	CMOS	Input
REQ[0]#	K3	Source Synch	Input/Output
REQ[1]#	H2	Source Synch	Input/Output
REQ[2]#	K2	Source Synch	Input/Output
REQ[3]#	J3	Source Synch	Input/Output
REQ[4]#	L1	Source Synch	Input/Output
RESET#	C1	Common Clock	Input



**Table 13. Pin Listing by Pin Name (Sheet 7 of 15)**

Pin Name	Pin Number	Signal Buffer Type	Direction
RS[0]#	F3	Common Clock	Input
RS[1]#	F4	Common Clock	Input
RS[2]#	G3	Common Clock	Input
RSVD	B2	Reserved	
RSVD	C3	Reserved	
RSVD	D2	Reserved	
RSVD	D3	Reserved	
RSVD	D22	Reserved	
RSVD	F6	Reserved	
RSVD	M4	Reserved	
RSVD	N5	Reserved	
RSVD	T2	Reserved	
RSVD	V3	Reserved	
SLP#	D7	CMOS	Input
SMI#	A3	CMOS	Input
STPCLK#	D5	CMOS	Input
TCK	AC5	CMOS	Input
TDI	AA6	CMOS	Input
TDO	AB3	Open Drain	Output
TEST1	C23	Test	
TEST2	D25	Test	
TEST3	C24	Test	
TEST4	AF26	Test	
TEST5	AF1	Test	
TEST6	A26	Test	
THERMTRIP#	C7	Open Drain	Output
THRMDA	A24	Power/Other	
THRMDC	B25	Power/Other	
TMS	AB5	CMOS	Input
TRDY#	G2	Common Clock	Input
TRST#	AB6	CMOS	Input
VCC	A7	Power/Other	
VCC	A9	Power/Other	
VCC	A10	Power/Other	
VCC	A12	Power/Other	
VCC	A13	Power/Other	
VCC	A15	Power/Other	
VCC	A17	Power/Other	
VCC	A18	Power/Other	

**Table 13. Pin Listing by Pin Name (Sheet 8 of 15)**

Pin Name	Pin Number	Signal Buffer Type	Direction
VCC	A20	Power/Other	
VCC	AA7	Power/Other	
VCC	AA9	Power/Other	
VCC	AA10	Power/Other	
VCC	AA12	Power/Other	
VCC	AA13	Power/Other	
VCC	AA15	Power/Other	
VCC	AA17	Power/Other	
VCC	AA18	Power/Other	
VCC	AA20	Power/Other	
VCC	AB7	Power/Other	
VCC	AB9	Power/Other	
VCC	AB10	Power/Other	
VCC	AB12	Power/Other	
VCC	AB14	Power/Other	
VCC	AB15	Power/Other	
VCC	AB17	Power/Other	
VCC	AB18	Power/Other	
VCC	AB20	Power/Other	
VCC	AC7	Power/Other	
VCC	AC9	Power/Other	
VCC	AC10	Power/Other	
VCC	AC12	Power/Other	
VCC	AC13	Power/Other	
VCC	AC15	Power/Other	
VCC	AC17	Power/Other	
VCC	AC18	Power/Other	
VCC	AD7	Power/Other	
VCC	AD9	Power/Other	
VCC	AD10	Power/Other	
VCC	AD12	Power/Other	
VCC	AD14	Power/Other	
VCC	AD15	Power/Other	
VCC	AD17	Power/Other	
VCC	AD18	Power/Other	
VCC	AE9	Power/Other	
VCC	AE10	Power/Other	
VCC	AE12	Power/Other	
VCC	AE13	Power/Other	





**Table 13. Pin Listing by Pin Name (Sheet 9 of 15)**

Pin Name	Pin Number	Signal Buffer Type	Direction
VCC	AE15	Power/Other	
VCC	AE17	Power/Other	
VCC	AE18	Power/Other	
VCC	AE20	Power/Other	
VCC	AF9	Power/Other	
VCC	AF10	Power/Other	
VCC	AF12	Power/Other	
VCC	AF14	Power/Other	
VCC	AF15	Power/Other	
VCC	AF17	Power/Other	
VCC	AF18	Power/Other	
VCC	AF20	Power/Other	
VCC	B7	Power/Other	
VCC	B9	Power/Other	
VCC	B10	Power/Other	
VCC	B12	Power/Other	
VCC	B14	Power/Other	
VCC	B15	Power/Other	
VCC	B17	Power/Other	
VCC	B18	Power/Other	
VCC	B20	Power/Other	
VCC	C9	Power/Other	
VCC	C10	Power/Other	
VCC	C12	Power/Other	
VCC	C13	Power/Other	
VCC	C15	Power/Other	
VCC	C17	Power/Other	
VCC	C18	Power/Other	
VCC	D9	Power/Other	
VCC	D10	Power/Other	
VCC	D12	Power/Other	
VCC	D14	Power/Other	
VCC	D15	Power/Other	
VCC	D17	Power/Other	
VCC	D18	Power/Other	
VCC	E7	Power/Other	
VCC	E9	Power/Other	
VCC	E10	Power/Other	
VCC	E12	Power/Other	

**Table 13. Pin Listing by Pin Name (Sheet 10 of 15)**

Pin Name	Pin Number	Signal Buffer Type	Direction
VCC	E13	Power/Other	
VCC	E15	Power/Other	
VCC	E17	Power/Other	
VCC	E18	Power/Other	
VCC	E20	Power/Other	
VCC	F7	Power/Other	
VCC	F9	Power/Other	
VCC	F10	Power/Other	
VCC	F12	Power/Other	
VCC	F14	Power/Other	
VCC	F15	Power/Other	
VCC	F17	Power/Other	
VCC	F18	Power/Other	
VCC	F20	Power/Other	
VCCA	B26	Power/Other	
VCCA	C26	Power/Other	
VCCP	G21	Power/Other	
VCCP	J6	Power/Other	
VCCP	J21	Power/Other	
VCCP	K6	Power/Other	
VCCP	K21	Power/Other	
VCCP	M6	Power/Other	
VCCP	M21	Power/Other	
VCCP	N6	Power/Other	
VCCP	N21	Power/Other	
VCCP	R6	Power/Other	
VCCP	R21	Power/Other	
VCCP	T6	Power/Other	
VCCP	T21	Power/Other	
VCCP	V6	Power/Other	
VCCP	V21	Power/Other	
VCCP	W21	Power/Other	
VCCSENSE	AF7	Power/Other	
VID[0]	AD6	CMOS	Output
VID[1]	AF5	CMOS	Output
VID[2]	AE5	CMOS	Output
VID[3]	AF4	CMOS	Output
VID[4]	AE3	CMOS	Output
VID[5]	AF3	CMOS	Output

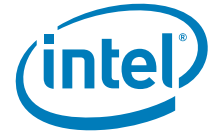

**Table 13. Pin Listing by Pin Name (Sheet 11 of 15)**

Pin Name	Pin Number	Signal Buffer Type	Direction
VID[6]	AE2	CMOS	Output
VSS	A2	Power/Other	
VSS	A4	Power/Other	
VSS	A8	Power/Other	
VSS	A11	Power/Other	
VSS	A14	Power/Other	
VSS	A16	Power/Other	
VSS	A19	Power/Other	
VSS	A23	Power/Other	
VSS	A25	Power/Other	
VSS	AA2	Power/Other	
VSS	AA5	Power/Other	
VSS	AA8	Power/Other	
VSS	AA11	Power/Other	
VSS	AA14	Power/Other	
VSS	AA16	Power/Other	
VSS	AA19	Power/Other	
VSS	AA22	Power/Other	
VSS	AA25	Power/Other	
VSS	AB1	Power/Other	
VSS	AB4	Power/Other	
VSS	AB8	Power/Other	
VSS	AB11	Power/Other	
VSS	AB13	Power/Other	
VSS	AB16	Power/Other	
VSS	AB19	Power/Other	
VSS	AB23	Power/Other	
VSS	AB26	Power/Other	
VSS	AC3	Power/Other	
VSS	AC6	Power/Other	
VSS	AC8	Power/Other	
VSS	AC11	Power/Other	
VSS	AC14	Power/Other	
VSS	AC16	Power/Other	
VSS	AC19	Power/Other	
VSS	AC21	Power/Other	
VSS	AC24	Power/Other	
VSS	AD2	Power/Other	
VSS	AD5	Power/Other	

**Table 13. Pin Listing by Pin Name (Sheet 12 of 15)**

Pin Name	Pin Number	Signal Buffer Type	Direction
VSS	AD8	Power/Other	
VSS	AD11	Power/Other	
VSS	AD13	Power/Other	
VSS	AD16	Power/Other	
VSS	AD19	Power/Other	
VSS	AD22	Power/Other	
VSS	AD25	Power/Other	
VSS	AE1	Power/Other	
VSS	AE4	Power/Other	
VSS	AE8	Power/Other	
VSS	AE11	Power/Other	
VSS	AE14	Power/Other	
VSS	AE16	Power/Other	
VSS	AE19	Power/Other	
VSS	AE23	Power/Other	
VSS	AE26	Power/Other	
VSS	AF2	Power/Other	
VSS	AF6	Power/Other	
VSS	AF8	Power/Other	
VSS	AF11	Power/Other	
VSS	AF13	Power/Other	
VSS	AF16	Power/Other	
VSS	AF19	Power/Other	
VSS	AF21	Power/Other	
VSS	AF25	Power/Other	
VSS	B6	Power/Other	
VSS	B8	Power/Other	
VSS	B11	Power/Other	
VSS	B13	Power/Other	
VSS	B16	Power/Other	
VSS	B19	Power/Other	
VSS	B21	Power/Other	
VSS	B24	Power/Other	
VSS	C2	Power/Other	
VSS	C5	Power/Other	
VSS	C8	Power/Other	
VSS	C11	Power/Other	
VSS	C14	Power/Other	
VSS	C16	Power/Other	



**Table 13. Pin Listing by Pin Name (Sheet 13 of 15)**

Pin Name	Pin Number	Signal Buffer Type	Direction
VSS	C19	Power/Other	
VSS	C22	Power/Other	
VSS	C25	Power/Other	
VSS	D1	Power/Other	
VSS	D4	Power/Other	
VSS	D8	Power/Other	
VSS	D11	Power/Other	
VSS	D13	Power/Other	
VSS	D16	Power/Other	
VSS	D19	Power/Other	
VSS	D23	Power/Other	
VSS	D26	Power/Other	
VSS	E3	Power/Other	
VSS	E6	Power/Other	
VSS	E8	Power/Other	
VSS	E11	Power/Other	
VSS	E14	Power/Other	
VSS	E16	Power/Other	
VSS	E19	Power/Other	
VSS	E21	Power/Other	
VSS	E24	Power/Other	
VSS	F2	Power/Other	
VSS	F5	Power/Other	
VSS	F8	Power/Other	
VSS	F11	Power/Other	
VSS	F13	Power/Other	
VSS	F16	Power/Other	
VSS	F19	Power/Other	
VSS	F22	Power/Other	
VSS	F25	Power/Other	
VSS	G1	Power/Other	
VSS	G4	Power/Other	
VSS	G23	Power/Other	
VSS	G26	Power/Other	
VSS	H3	Power/Other	
VSS	H6	Power/Other	
VSS	H21	Power/Other	
VSS	H24	Power/Other	
VSS	J2	Power/Other	

**Table 13. Pin Listing by Pin Name (Sheet 14 of 15)**

Pin Name	Pin Number	Signal Buffer Type	Direction
VSS	J5	Power/Other	
VSS	J22	Power/Other	
VSS	J25	Power/Other	
VSS	K1	Power/Other	
VSS	K4	Power/Other	
VSS	K23	Power/Other	
VSS	K26	Power/Other	
VSS	L3	Power/Other	
VSS	L6	Power/Other	
VSS	L21	Power/Other	
VSS	L24	Power/Other	
VSS	M2	Power/Other	
VSS	M5	Power/Other	
VSS	M22	Power/Other	
VSS	M25	Power/Other	
VSS	N1	Power/Other	
VSS	N4	Power/Other	
VSS	N23	Power/Other	
VSS	N26	Power/Other	
VSS	P3	Power/Other	
VSS	P6	Power/Other	
VSS	P21	Power/Other	
VSS	P24	Power/Other	
VSS	R2	Power/Other	
VSS	R5	Power/Other	
VSS	R22	Power/Other	
VSS	R25	Power/Other	
VSS	T1	Power/Other	
VSS	T4	Power/Other	
VSS	T23	Power/Other	
VSS	T26	Power/Other	
VSS	U3	Power/Other	
VSS	U6	Power/Other	
VSS	U21	Power/Other	
VSS	U24	Power/Other	
VSS	V2	Power/Other	
VSS	V5	Power/Other	
VSS	V22	Power/Other	
VSS	V25	Power/Other	



**Table 13. Pin Listing by Pin Name (Sheet 15 of 15)**

Pin Name	Pin Number	Signal Buffer Type	Direction
VSS	W1	Power/Other	
VSS	W4	Power/Other	
VSS	W23	Power/Other	
VSS	W26	Power/Other	
VSS	Y3	Power/Other	
VSS	Y6	Power/Other	
VSS	Y21	Power/Other	
VSS	Y24	Power/Other	
VSSSENSE	AE7	Power/Other	Output

**Table 14. Pin Listing by Pin Number (Sheet 2 of 17)**

Pin Name	Pin Number	Signal Buffer Type	Direction
THRMDA	A24	Power/Other	
VSS	A25	Power/Other	
TEST6	A26	Test	
COMP[2]	AA1	Power/Other	Input/Output
VSS	AA2	Power/Other	
A[35]#	AA3	Source Synch	Input/Output
A[33]#	AA4	Source Synch	Input/Output
VSS	AA5	Power/Other	
TDI	AA6	CMOS	Input
VCC	AA7	Power/Other	
VSS	AA8	Power/Other	
VCC	AA9	Power/Other	
VCC	AA10	Power/Other	
VSS	AA11	Power/Other	
VCC	AA12	Power/Other	
VCC	AA13	Power/Other	
VSS	AA14	Power/Other	
VCC	AA15	Power/Other	
VSS	AA16	Power/Other	
VCC	AA17	Power/Other	
VCC	AA18	Power/Other	
VSS	AA19	Power/Other	
VCC	AA20	Power/Other	
D[50]#	AA21	Source Synch	Input/Output
VSS	AA22	Power/Other	
D[45]#	AA23	Source Synch	Input/Output
D[46]#	AA24	Source Synch	Input/Output
VSS	AA25	Power/Other	
DSTBP[2]#	AA26	Source Synch	Input/Output
VSS	AB1	Power/Other	
A[34]#	AB2	Source Synch	Input/Output

**Table 14. Pin Listing by Pin Number (Sheet 1 of 17)**

Pin Name	Pin Number	Signal Buffer Type	Direction
VSS	A2	Power/Other	
SMI#	A3	CMOS	Input
VSS	A4	Power/Other	
FERR#	A5	Open Drain	Output
A20M#	A6	CMOS	Input
VCC	A7	Power/Other	
VSS	A8	Power/Other	
VCC	A9	Power/Other	
VCC	A10	Power/Other	
VSS	A11	Power/Other	
VCC	A12	Power/Other	
VCC	A13	Power/Other	
VSS	A14	Power/Other	
VCC	A15	Power/Other	
VSS	A16	Power/Other	
VCC	A17	Power/Other	
VCC	A18	Power/Other	
VSS	A19	Power/Other	
VCC	A20	Power/Other	
BCLK[1]	A21	Bus Clock	Input
BCLK[0]	A22	Bus Clock	Input
VSS	A23	Power/Other	



**Table 14. Pin Listing by Pin Number (Sheet 3 of 17)**

Pin Name	Pin Number	Signal Buffer Type	Direction
TDO	AB3	Open Drain	Output
VSS	AB4	Power/Other	
TMS	AB5	CMOS	Input
TRST#	AB6	CMOS	Input
VCC	AB7	Power/Other	
VSS	AB8	Power/Other	
VCC	AB9	Power/Other	
VCC	AB10	Power/Other	
VSS	AB11	Power/Other	
VCC	AB12	Power/Other	
VSS	AB13	Power/Other	
VCC	AB14	Power/Other	
VCC	AB15	Power/Other	
VSS	AB16	Power/Other	
VCC	AB17	Power/Other	
VCC	AB18	Power/Other	
VSS	AB19	Power/Other	
VCC	AB20	Power/Other	
D[52]#	AB21	Source Synch	Input/Output
D[51]#	AB22	Source Synch	Input/Output
VSS	AB23	Power/Other	
D[33]#	AB24	Source Synch	Input/Output
D[47]#	AB25	Source Synch	Input/Output
VSS	AB26	Power/Other	
PREQ#	AC1	Common Clock	Input
PRDY#	AC2	Common Clock	Output
VSS	AC3	Power/Other	
BPM[3]#	AC4	Common Clock	Input/Output
TCK	AC5	CMOS	Input
VSS	AC6	Power/Other	
VCC	AC7	Power/Other	
VSS	AC8	Power/Other	

**Table 14. Pin Listing by Pin Number (Sheet 4 of 17)**

Pin Name	Pin Number	Signal Buffer Type	Direction
VCC	AC9	Power/Other	
VCC	AC10	Power/Other	
VSS	AC11	Power/Other	
VCC	AC12	Power/Other	
VCC	AC13	Power/Other	
VSS	AC14	Power/Other	
VCC	AC15	Power/Other	
VSS	AC16	Power/Other	
VCC	AC17	Power/Other	
VCC	AC18	Power/Other	
VSS	AC19	Power/Other	
DINV[3]#	AC20	Source Synch	Input/Output
VSS	AC21	Power/Other	
D[60]#	AC22	Source Synch	Input/Output
D[63]#	AC23	Source Synch	Input/Output
VSS	AC24	Power/Other	
D[57]#	AC25	Source Synch	Input/Output
D[53]#	AC26	Source Synch	Input/Output
BPM[2]#	AD1	Common Clock	Output
VSS	AD2	Power/Other	
BPM[1]#	AD3	Common Clock	Output
BPM[0]#	AD4	Common Clock	Input/Output
VSS	AD5	Power/Other	
VID[0]	AD6	CMOS	Output
VCC	AD7	Power/Other	
VSS	AD8	Power/Other	
VCC	AD9	Power/Other	
VCC	AD10	Power/Other	
VSS	AD11	Power/Other	
VCC	AD12	Power/Other	
VSS	AD13	Power/Other	



**Table 14. Pin Listing by Pin Number (Sheet 5 of 17)**

Pin Name	Pin Number	Signal Buffer Type	Direction
VCC	AD14	Power/Other	
VCC	AD15	Power/Other	
VSS	AD16	Power/Other	
VCC	AD17	Power/Other	
VCC	AD18	Power/Other	
VSS	AD19	Power/Other	
D[54]#	AD20	Source Synch	Input/Output
D[59]#	AD21	Source Synch	Input/Output
VSS	AD22	Power/Other	
D[61]#	AD23	Source Synch	Input/Output
D[49]#	AD24	Source Synch	Input/Output
VSS	AD25	Power/Other	
GTLREF	AD26	Power/Other	Input
VSS	AE1	Power/Other	
VID[6]	AE2	CMOS	Output
VID[4]	AE3	CMOS	Output
VSS	AE4	Power/Other	
VID[2]	AE5	CMOS	Output
PSI#	AE6	CMOS	Output
VSSSENSE	AE7	Power/Other	Output
VSS	AE8	Power/Other	
VCC	AE9	Power/Other	
VCC	AE10	Power/Other	
VSS	AE11	Power/Other	
VCC	AE12	Power/Other	
VCC	AE13	Power/Other	
VSS	AE14	Power/Other	
VCC	AE15	Power/Other	
VSS	AE16	Power/Other	
VCC	AE17	Power/Other	
VCC	AE18	Power/Other	
VSS	AE19	Power/Other	
VCC	AE20	Power/Other	

**Table 14. Pin Listing by Pin Number (Sheet 6 of 17)**

Pin Name	Pin Number	Signal Buffer Type	Direction
D[58]#	AE21	Source Synch	Input/Output
D[55]#	AE22	Source Synch	Input/Output
VSS	AE23	Power/Other	
D[48]#	AE24	Source Synch	Input/Output
DSTBN[3]#	AE25	Source Synch	Input/Output
VSS	AE26	Power/Other	
TEST5	AF1	Test	
VSS	AF2	Power/Other	
VID[5]	AF3	CMOS	Output
VID[3]	AF4	CMOS	Output
VID[1]	AF5	CMOS	Output
VSS	AF6	Power/Other	
VCCSENSE	AF7	Power/Other	
VSS	AF8	Power/Other	
VCC	AF9	Power/Other	
VCC	AF10	Power/Other	
VSS	AF11	Power/Other	
VCC	AF12	Power/Other	
VSS	AF13	Power/Other	
VCC	AF14	Power/Other	
VCC	AF15	Power/Other	
VSS	AF16	Power/Other	
VCC	AF17	Power/Other	
VCC	AF18	Power/Other	
VSS	AF19	Power/Other	
VCC	AF20	Power/Other	
VSS	AF21	Power/Other	
D[62]#	AF22	Source Synch	Input/Output
D[56]#	AF23	Source Synch	Input/Output
DSTBP[3]#	AF24	Source Synch	Input/Output
VSS	AF25	Power/Other	
TEST4	AF26	Test	



**Table 14. Pin Listing by Pin Number (Sheet 7 of 17)**

Pin Name	Pin Number	Signal Buffer Type	Direction
RSVD	B2	Reserved	
INIT#	B3	CMOS	Input
LINT1	B4	CMOS	Input
DPSLP#	B5	CMOS	Input
VSS	B6	Power/Other	
VCC	B7	Power/Other	
VSS	B8	Power/Other	
VCC	B9	Power/Other	
VCC	B10	Power/Other	
VSS	B11	Power/Other	
VCC	B12	Power/Other	
VSS	B13	Power/Other	
VCC	B14	Power/Other	
VCC	B15	Power/Other	
VSS	B16	Power/Other	
VCC	B17	Power/Other	
VCC	B18	Power/Other	
VSS	B19	Power/Other	
VCC	B20	Power/Other	
VSS	B21	Power/Other	
BSEL[0]	B22	CMOS	Output
BSEL[1]	B23	CMOS	Output
VSS	B24	Power/Other	
THRMDC	B25	Power/Other	
VCCA	B26	Power/Other	
RESET#	C1	Common Clock	Input
VSS	C2	Power/Other	
RSVD	C3	Reserved	
IGNNE#	C4	CMOS	Input
VSS	C5	Power/Other	
LINT0	C6	CMOS	Input
THERMTRIP #	C7	Open Drain	Output
VSS	C8	Power/Other	
VCC	C9	Power/Other	
VCC	C10	Power/Other	

**Table 14. Pin Listing by Pin Number (Sheet 8 of 17)**

Pin Name	Pin Number	Signal Buffer Type	Direction
VSS	C11	Power/Other	
VCC	C12	Power/Other	
VCC	C13	Power/Other	
VSS	C14	Power/Other	
VCC	C15	Power/Other	
VSS	C16	Power/Other	
VCC	C17	Power/Other	
VCC	C18	Power/Other	
VSS	C19	Power/Other	
DBR#	C20	CMOS	Output
BSEL[2]	C21	CMOS	Output
VSS	C22	Power/Other	
TEST1	C23	Test	
TEST3	C24	Test	
VSS	C25	Power/Other	
VCCA	C26	Power/Other	
VSS	D1	Power/Other	
RSVD	D2	Reserved	
RSVD	D3	Reserved	
VSS	D4	Power/Other	
STPCLK#	D5	CMOS	Input
PWRGOOD	D6	CMOS	Input
SLP#	D7	CMOS	Input
VSS	D8	Power/Other	
VCC	D9	Power/Other	
VCC	D10	Power/Other	
VSS	D11	Power/Other	
VCC	D12	Power/Other	
VSS	D13	Power/Other	
VCC	D14	Power/Other	
VCC	D15	Power/Other	
VSS	D16	Power/Other	
VCC	D17	Power/Other	
VCC	D18	Power/Other	
VSS	D19	Power/Other	
IERR#	D20	Open Drain	Output



**Table 14. Pin Listing by Pin Number (Sheet 9 of 17)**

Pin Name	Pin Number	Signal Buffer Type	Direction
PROCHOT#	D21	Open Drain	Input/Output
RSVD	D22	Reserved	
VSS	D23	Power/Other	
DPWR#	D24	Common Clock	Input/Output
TEST2	D25	Test	
VSS	D26	Power/Other	
DBSY#	E1	Common Clock	Input/Output
BNR#	E2	Common Clock	Input/Output
VSS	E3	Power/Other	
HITM#	E4	Common Clock	Input/Output
DPRSTP#	E5	CMOS	Input
VSS	E6	Power/Other	
VCC	E7	Power/Other	
VSS	E8	Power/Other	
VCC	E9	Power/Other	
VCC	E10	Power/Other	
VSS	E11	Power/Other	
VCC	E12	Power/Other	
VCC	E13	Power/Other	
VSS	E14	Power/Other	
VCC	E15	Power/Other	
VSS	E16	Power/Other	
VCC	E17	Power/Other	
VCC	E18	Power/Other	
VSS	E19	Power/Other	
VCC	E20	Power/Other	
VSS	E21	Power/Other	
D[0]#	E22	Source Synch	Input/Output
D[7]#	E23	Source Synch	Input/Output
VSS	E24	Power/Other	
D[6]#	E25	Source Synch	Input/Output

**Table 14. Pin Listing by Pin Number (Sheet 10 of 17)**

Pin Name	Pin Number	Signal Buffer Type	Direction
D[2]#	E26	Source Synch	Input/Output
BR0#	F1	Common Clock	Input/Output
VSS	F2	Power/Other	
RS[0]#	F3	Common Clock	Input
RS[1]#	F4	Common Clock	Input
VSS	F5	Power/Other	
RSVD	F6	Reserved	
VCC	F7	Power/Other	
VSS	F8	Power/Other	
VCC	F9	Power/Other	
VCC	F10	Power/Other	
VSS	F11	Power/Other	
VCC	F12	Power/Other	
VSS	F13	Power/Other	
VCC	F14	Power/Other	
VCC	F15	Power/Other	
VSS	F16	Power/Other	
VCC	F17	Power/Other	
VCC	F18	Power/Other	
VSS	F19	Power/Other	
VCC	F20	Power/Other	
DRDY#	F21	Common Clock	Input/Output
VSS	F22	Power/Other	
D[4]#	F23	Source Synch	Input/Output
D[1]#	F24	Source Synch	Input/Output
VSS	F25	Power/Other	
D[13]#	F26	Source Synch	Input/Output
VSS	G1	Power/Other	
TRDY#	G2	Common Clock	Input
RS[2]#	G3	Common Clock	Input



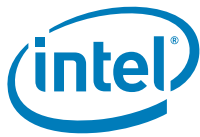

**Table 14. Pin Listing by Pin Number (Sheet 11 of 17)**

Pin Name	Pin Number	Signal Buffer Type	Direction
VSS	G4	Power/Other	
BPRI#	G5	Common Clock	Input
HIT#	G6	Common Clock	Input/Output
VCCP	G21	Power/Other	
D[3]#	G22	Source Synch	Input/Output
VSS	G23	Power/Other	
D[9]#	G24	Source Synch	Input/Output
D[5]#	G25	Source Synch	Input/Output
VSS	G26	Power/Other	
ADS#	H1	Common Clock	Input/Output
REQ[1]#	H2	Source Synch	Input/Output
VSS	H3	Power/Other	
LOCK#	H4	Common Clock	Input/Output
DEFER#	H5	Common Clock	Input
VSS	H6	Power/Other	
VSS	H21	Power/Other	
D[12]#	H22	Source Synch	Input/Output
D[15]#	H23	Source Synch	Input/Output
VSS	H24	Power/Other	
DINV[0]#	H25	Source Synch	Input/Output
DSTBP[0]#	H26	Source Synch	Input/Output
A[9]#	J1	Source Synch	Input/Output
VSS	J2	Power/Other	
REQ[3]#	J3	Source Synch	Input/Output
A[3]#	J4	Source Synch	Input/Output
VSS	J5	Power/Other	

**Table 14. Pin Listing by Pin Number (Sheet 12 of 17)**

Pin Name	Pin Number	Signal Buffer Type	Direction
VCCP	J6	Power/Other	
VCCP	J21	Power/Other	
VSS	J22	Power/Other	
D[11]#	J23	Source Synch	Input/Output
D[10]#	J24	Source Synch	Input/Output
VSS	J25	Power/Other	
DSTBN[0]#	J26	Source Synch	Input/Output
VSS	K1	Power/Other	
REQ[2]#	K2	Source Synch	Input/Output
REQ[0]#	K3	Source Synch	Input/Output
VSS	K4	Power/Other	
A[6]#	K5	Source Synch	Input/Output
VCCP	K6	Power/Other	
VCCP	K21	Power/Other	
D[14]#	K22	Source Synch	Input/Output
VSS	K23	Power/Other	
D[8]#	K24	Source Synch	Input/Output
D[17]#	K25	Source Synch	Input/Output
VSS	K26	Power/Other	
REQ[4]#	L1	Source Synch	Input/Output
A[13]#	L2	Source Synch	Input/Output
VSS	L3	Power/Other	
A[5]#	L4	Source Synch	Input/Output
A[4]#	L5	Source Synch	Input/Output
VSS	L6	Power/Other	
VSS	L21	Power/Other	
D[22]#	L22	Source Synch	Input/Output



**Table 14. Pin Listing by Pin Number (Sheet 13 of 17)**

Pin Name	Pin Number	Signal Buffer Type	Direction
D[20]#	L23	Source Synch	Input/Output
VSS	L24	Power/Other	
D[29]#	L25	Source Synch	Input/Output
DSTBN[1]#	L26	Source Synch	Input/Output
ADSTB[0]#	M1	Source Synch	Input/Output
VSS	M2	Power/Other	
A[7]#	M3	Source Synch	Input/Output
RSVD	M4	Reserved	
VSS	M5	Power/Other	
VCCP	M6	Power/Other	
VCCP	M21	Power/Other	
VSS	M22	Power/Other	
D[23]#	M23	Source Synch	Input/Output
D[21]#	M24	Source Synch	Input/Output
VSS	M25	Power/Other	
DSTBP[1]#	M26	Source Synch	Input/Output
VSS	N1	Power/Other	
A[8]#	N2	Source Synch	Input/Output
A[10]#	N3	Source Synch	Input/Output
VSS	N4	Power/Other	
RSVD	N5	Reserved	
VCCP	N6	Power/Other	
VCCP	N21	Power/Other	
D[16]#	N22	Source Synch	Input/Output
VSS	N23	Power/Other	
DINV[1]#	N24	Source Synch	Input/Output
D[31]#	N25	Source Synch	Input/Output
VSS	N26	Power/Other	

**Table 14. Pin Listing by Pin Number (Sheet 14 of 17)**

Pin Name	Pin Number	Signal Buffer Type	Direction
A[15]#	P1	Source Synch	Input/Output
A[12]#	P2	Source Synch	Input/Output
VSS	P3	Power/Other	
A[14]#	P4	Source Synch	Input/Output
A[11]#	P5	Source Synch	Input/Output
VSS	P6	Power/Other	
VSS	P21	Power/Other	
D[26]#	P22	Source Synch	Input/Output
D[25]#	P23	Source Synch	Input/Output
VSS	P24	Power/Other	
D[24]#	P25	Source Synch	Input/Output
D[18]#	P26	Source Synch	Input/Output
A[16]#	R1	Source Synch	Input/Output
VSS	R2	Power/Other	
A[19]#	R3	Source Synch	Input/Output
A[24]#	R4	Source Synch	Input/Output
VSS	R5	Power/Other	
VCCP	R6	Power/Other	
VCCP	R21	Power/Other	
VSS	R22	Power/Other	
D[19]#	R23	Source Synch	Input/Output
D[28]#	R24	Source Synch	Input/Output
VSS	R25	Power/Other	
COMP[0]	R26	Power/Other	Input/Output
VSS	T1	Power/Other	
RSVD	T2	Reserved	



**Table 14. Pin Listing by Pin Number (Sheet 15 of 17)**

Pin Name	Pin Number	Signal Buffer Type	Direction
A[26]#	T3	Source Synch	Input/Output
VSS	T4	Power/Other	
A[25]#	T5	Source Synch	Input/Output
VCCP	T6	Power/Other	
VCCP	T21	Power/Other	
D[37]#	T22	Source Synch	Input/Output
VSS	T23	Power/Other	
D[27]#	T24	Source Synch	Input/Output
D[30]#	T25	Source Synch	Input/Output
VSS	T26	Power/Other	
A[23]#	U1	Source Synch	Input/Output
A[30]#	U2	Source Synch	Input/Output
VSS	U3	Power/Other	
A[21]#	U4	Source Synch	Input/Output
A[18]#	U5	Source Synch	Input/Output
VSS	U6	Power/Other	
VSS	U21	Power/Other	
DINV[2]#	U22	Source Synch	Input/Output
D[39]#	U23	Source Synch	Input/Output
VSS	U24	Power/Other	
D[38]#	U25	Source Synch	Input/Output
COMP[1]	U26	Power/Other	Input/Output
ADSTB[1]#	V1	Source Synch	Input/Output
VSS	V2	Power/Other	
RSVD	V3	Reserved	
A[31]#	V4	Source Synch	Input/Output

**Table 14. Pin Listing by Pin Number (Sheet 16 of 17)**

Pin Name	Pin Number	Signal Buffer Type	Direction
VSS	V5	Power/Other	
VCCP	V6	Power/Other	
VCCP	V21	Power/Other	
VSS	V22	Power/Other	
D[36]#	V23	Source Synch	Input/Output
D[34]#	V24	Source Synch	Input/Output
VSS	V25	Power/Other	
D[35]#	V26	Source Synch	Input/Output
VSS	W1	Power/Other	
A[27]#	W2	Source Synch	Input/Output
A[32]#	W3	Source Synch	Input/Output
VSS	W4	Power/Other	
A[28]#	W5	Source Synch	Input/Output
A[20]#	W6	Source Synch	Input/Output
VCCP	W21	Power/Other	
D[41]#	W22	Source Synch	Input/Output
VSS	W23	Power/Other	
D[43]#	W24	Source Synch	Input/Output
D[44]#	W25	Source Synch	Input/Output
VSS	W26	Power/Other	
COMP[3]	Y1	Power/Other	Input/Output
A[17]#	Y2	Source Synch	Input/Output
VSS	Y3	Power/Other	
A[29]#	Y4	Source Synch	Input/Output
A[22]#	Y5	Source Synch	Input/Output
VSS	Y6	Power/Other	
VSS	Y21	Power/Other	



**Table 14. Pin Listing by Pin Number  
(Sheet 17 of 17)**

Pin Name	Pin Number	Signal Buffer Type	Direction
D[32]#	Y22	Source Synch	Input/ Output
D[42]#	Y23	Source Synch	Input/ Output
VSS	Y24	Power/Other	
D[40]#	Y25	Source Synch	Input/ Output
DSTBN[2]#	Y26	Source Synch	Input/ Output



### 4.3 Alphabetical Signals Reference

Table 15. Signal Description (Sheet 1 of 8)

Name	Type	Description						
A[35:3]#	Input/Output	<p>A[35:3]# (Address) define a 2<sup>36</sup>-byte physical memory address space. In sub-phase 1 of the address phase, these pins transmit the address of a transaction. In sub-phase 2, these pins transmit transaction type information. These signals must connect the appropriate pins of both agents on the Intel® Celeron® FSB. A[35:3]# are source synchronous signals and are latched into the receiving buffers by ADSTB[1:0]#. Address signals are used as straps which are sampled before RESET# is deasserted.</p> <p><b>NOTE: When paired with a chipset limited to 32-bit addressing, A[35:32] should remain unconnected</b></p>						
A20M#	Input	<p>If A20M# (Address-20 Mask) is asserted, the processor masks physical address bit 20 (A20#) before looking up a line in any internal cache and before driving a read/write transaction on the bus. Asserting A20M# emulates the 8086 processor's address wrap-around at the 1-Mbyte boundary. Assertion of A20M# is only supported in real mode.</p> <p>A20M# is an asynchronous signal. However, to ensure recognition of this signal following an Input/Output write instruction, it must be valid along with the TRDY# assertion of the corresponding Input/Output Write bus transaction.</p>						
ADS#	Input/Output	<p>ADS# (Address Strobe) is asserted to indicate the validity of the transaction address on the A[35:3]# and REQ[4:0]# pins. All bus agents observe the ADS# activation to begin parity checking, protocol checking, address decode, internal snoop, or deferred reply ID match operations associated with the new transaction.</p>						
ADSTB[1:0]#	Input/Output	<p>Address strobes are used to latch A[35:3]# and REQ[4:0]# on their rising and falling edges. Strobes are associated with signals as shown below.</p> <table border="1" style="margin-left: auto; margin-right: auto;"> <thead> <tr> <th>Signals</th> <th>Associated Strobe</th> </tr> </thead> <tbody> <tr> <td>REQ[4:0]#, A[16:3]#</td> <td>ADSTB[0]#</td> </tr> <tr> <td>A[35:17]#</td> <td>ADSTB[1]#</td> </tr> </tbody> </table>	Signals	Associated Strobe	REQ[4:0]#, A[16:3]#	ADSTB[0]#	A[35:17]#	ADSTB[1]#
Signals	Associated Strobe							
REQ[4:0]#, A[16:3]#	ADSTB[0]#							
A[35:17]#	ADSTB[1]#							
BCLK[1:0]	Input	<p>The differential pair BCLK (Bus Clock) determines the FSB frequency. All FSB agents must receive these signals to drive their outputs and latch their inputs.</p> <p>All external timing parameters are specified with respect to the rising edge of BCLK0 crossing V<sub>CROSS</sub>.</p>						
BNR#	Input/Output	<p>BNR# (Block Next Request) is used to assert a bus stall by any bus agent who is unable to accept new bus transactions. During a bus stall, the current bus owner cannot issue any new transactions.</p>						



Table 15. Signal Description (Sheet 2 of 8)

Name	Type	Description															
BPM[2:1]# BPM[3,0]#	Output Input/ Output	BPM[3:0]# (Breakpoint Monitor) are breakpoint and performance monitor signals. They are outputs from the processor which indicate the status of breakpoints and programmable counters used for monitoring processor performance. BPM[3:0]# should connect the appropriate pins of all Celeron FSB agents. This includes debug or performance monitoring tools. Please refer to the platform design guide for more detailed information.															
BPRI#	Input	BPRI# (Bus Priority Request) is used to arbitrate for ownership of the FSB. It must connect the appropriate pins of both FSB agents. Observing BPRI# active (as asserted by the priority agent) causes the other agent to stop issuing new requests, unless such requests are part of an ongoing locked operation. The priority agent keeps BPRI# asserted until all of its requests are completed, then releases the bus by deasserting BPRI#.															
BRO#	Input/ Output	BRO# is used by the processor to request the bus. The arbitration is done between processor (Symmetric Agent) and (G)MCH-M (High Priority Agent).															
BSEL[2:0]	Output	BSEL[2:0] (Bus Select) are used to select the processor input clock frequency. Table 3 defines the possible combinations of the signals and the frequency associated with each combination. The required frequency is determined by the processor, chipset and clock synthesizer. All agents must operate at the same frequency. The Intel® Celeron® processor 500 series for platforms based on the Mobile Intel® 965 Express Chipset family operates at a 533-MHz system bus frequency (133-MHz BCLK[1:0] frequency).															
COMP[3:0]	Analog	COMP[3:0] must be terminated on the system board using precision (1% tolerance) resistors. Refer to the appropriate platform design guide for more details on implementation.															
D[63:0]#	Input/ Output	D[63:0]# (Data) are the data signals. These signals provide a 64-bit data path between the FSB agents, and must connect the appropriate pins on both agents. The data driver asserts DRDY# to indicate a valid data transfer. D[63:0]# are quad-pumped signals and are driven four times in a common clock period. D[63:0]# are latched off the falling edge of both DSTBP[3:0]# and DSTBN[3:0]#. Each group of 16 data signals correspond to a pair of one DSTBP# and one DSTBN#. The following table shows the grouping of data signals to data strobes and DINV#. <b>Quad-Pumped Signal Groups</b> <table border="1" style="margin-left: 20px;"> <thead> <tr> <th>Data Group</th> <th>DSTBN#/ DSTBP#</th> <th>DINV#</th> </tr> </thead> <tbody> <tr> <td>D[15:0]#</td> <td>0</td> <td>0</td> </tr> <tr> <td>D[31:16]#</td> <td>1</td> <td>1</td> </tr> <tr> <td>D[47:32]#</td> <td>2</td> <td>2</td> </tr> <tr> <td>D[63:48]#</td> <td>3</td> <td>3</td> </tr> </tbody> </table> Furthermore, the DINV# pins determine the polarity of the data signals. Each group of 16 data signals corresponds to one DINV# signal. When the DINV# signal is active, the corresponding data group is inverted and therefore sampled active high.	Data Group	DSTBN#/ DSTBP#	DINV#	D[15:0]#	0	0	D[31:16]#	1	1	D[47:32]#	2	2	D[63:48]#	3	3
Data Group	DSTBN#/ DSTBP#	DINV#															
D[15:0]#	0	0															
D[31:16]#	1	1															
D[47:32]#	2	2															
D[63:48]#	3	3															



Table 15. Signal Description (Sheet 3 of 8)

Name	Type	Description										
DBR#	Output	DBR# (Data Bus Reset) is used only in processor systems where no debug port is implemented on the system board. DBR# is used by a debug port interposer so that an in-target probe can drive system reset. If a debug port is implemented in the system, DBR# is a no connect in the system. DBR# is not a processor signal.										
DBSY#	Input/Output	DBSY# (Data Bus Busy) is asserted by the agent responsible for driving data on the FSB to indicate that the data bus is in use. The data bus is released after DBSY# is deasserted. This signal must connect the appropriate pins on both FSB agents.										
DEFER#	Input	DEFER# is asserted by an agent to indicate that a transaction cannot be guaranteed in-order completion. Assertion of DEFER# is normally the responsibility of the addressed memory or Input/Output agent. This signal must connect the appropriate pins of both FSB agents.										
DINV[3:0]#	Input/Output	<p>DINV[3:0]# (Data Bus Inversion) are source synchronous and indicate the polarity of the D[63:0]# signals. The DINV[3:0]# signals are activated when the data on the data bus is inverted. The bus agent inverts the data bus signals if more than half the bits, within the covered group, would change level in the next cycle.</p> <p><b>DINV[3:0]# Assignment to Data Bus</b></p> <table border="1"> <thead> <tr> <th>Bus Signal</th> <th>Data Bus Signals</th> </tr> </thead> <tbody> <tr> <td>DINV[3]#</td> <td>D[63:48]#</td> </tr> <tr> <td>DINV[2]#</td> <td>D[47:32]#</td> </tr> <tr> <td>DINV[1]#</td> <td>D[31:16]#</td> </tr> <tr> <td>DINV[0]#</td> <td>D[15:0]#</td> </tr> </tbody> </table>	Bus Signal	Data Bus Signals	DINV[3]#	D[63:48]#	DINV[2]#	D[47:32]#	DINV[1]#	D[31:16]#	DINV[0]#	D[15:0]#
Bus Signal	Data Bus Signals											
DINV[3]#	D[63:48]#											
DINV[2]#	D[47:32]#											
DINV[1]#	D[31:16]#											
DINV[0]#	D[15:0]#											
DPRSTP#	Input	DPRSTP# is not used by the processor. For termination requirements please refer to the platform design guide.										
DPSLP#	Input	DPSLP# when asserted on the platform causes the processor to transition from the Sleep state to the Deep Sleep state. In order to return to the Sleep state, DPSLP# must be deasserted. DPSLP# is driven by the Intel® ICH8M I/O controller.										
DPWR#	Input	DPWR# is a control signal used by the chipset to reduce power on the processor data bus input buffers. This is not utilized by this processor.										
DRDY#	Input/Output	DRDY# (Data Ready) is asserted by the data driver on each data transfer, indicating valid data on the data bus. In a multi-common clock data transfer, DRDY# may be deasserted to insert idle clocks. This signal must connect the appropriate pins of both FSB agents.										



Table 15. Signal Description (Sheet 4 of 8)

Name	Type	Description										
DSTBN[3:0]#	Input/Output	Data strobe used to latch in D[63:0]#.										
		<table border="1"> <thead> <tr> <th>Signals</th> <th>Associated Strobe</th> </tr> </thead> <tbody> <tr> <td>D[15:0]#, DINV[0]#</td> <td>DSTBN[0]#</td> </tr> <tr> <td>D[31:16]#, DINV[1]#</td> <td>DSTBN[1]#</td> </tr> <tr> <td>D[47:32]#, DINV[2]#</td> <td>DSTBN[2]#</td> </tr> <tr> <td>D[63:48]#, DINV[3]#</td> <td>DSTBN[3]#</td> </tr> </tbody> </table>	Signals	Associated Strobe	D[15:0]#, DINV[0]#	DSTBN[0]#	D[31:16]#, DINV[1]#	DSTBN[1]#	D[47:32]#, DINV[2]#	DSTBN[2]#	D[63:48]#, DINV[3]#	DSTBN[3]#
		Signals	Associated Strobe									
		D[15:0]#, DINV[0]#	DSTBN[0]#									
		D[31:16]#, DINV[1]#	DSTBN[1]#									
D[47:32]#, DINV[2]#	DSTBN[2]#											
D[63:48]#, DINV[3]#	DSTBN[3]#											
D[15:0]#, DINV[0]#	DSTBN[0]#											
D[31:16]#, DINV[1]#	DSTBN[1]#											
D[47:32]#, DINV[2]#	DSTBN[2]#											
D[63:48]#, DINV[3]#	DSTBN[3]#											
DSTBP[3:0]#	Input/Output	Data strobe used to latch in D[63:0]#.										
		<table border="1"> <thead> <tr> <th>Signals</th> <th>Associated Strobe</th> </tr> </thead> <tbody> <tr> <td>D[15:0]#, DINV[0]#</td> <td>DSTBP[0]#</td> </tr> <tr> <td>D[31:16]#, DINV[1]#</td> <td>DSTBP[1]#</td> </tr> <tr> <td>D[47:32]#, DINV[2]#</td> <td>DSTBP[2]#</td> </tr> <tr> <td>D[63:48]#, DINV[3]#</td> <td>DSTBP[3]#</td> </tr> </tbody> </table>	Signals	Associated Strobe	D[15:0]#, DINV[0]#	DSTBP[0]#	D[31:16]#, DINV[1]#	DSTBP[1]#	D[47:32]#, DINV[2]#	DSTBP[2]#	D[63:48]#, DINV[3]#	DSTBP[3]#
		Signals	Associated Strobe									
		D[15:0]#, DINV[0]#	DSTBP[0]#									
		D[31:16]#, DINV[1]#	DSTBP[1]#									
D[47:32]#, DINV[2]#	DSTBP[2]#											
D[63:48]#, DINV[3]#	DSTBP[3]#											
D[15:0]#, DINV[0]#	DSTBP[0]#											
D[31:16]#, DINV[1]#	DSTBP[1]#											
D[47:32]#, DINV[2]#	DSTBP[2]#											
D[63:48]#, DINV[3]#	DSTBP[3]#											
FERR#/PBE#	Output	<p>FERR# (Floating-point Error)/PBE#(Pending Break Event) is a multiplexed signal and its meaning is qualified with STPCLK#. When STPCLK# is not asserted, FERR#/PBE# assertion indicates that an unmasked floating point error has been detected. FERR# is similar to the ERROR# signal on the Intel 387 coprocessor, and is included for compatibility with systems using MS-DOS*-type floating-point error reporting. When STPCLK# is asserted, an assertion of FERR#/PBE# indicates that the processor has a pending break event waiting for service. In both cases, assertion of FERR#/PBE# indicates that the processor should be returned to the Normal state. When FERR#/PBE# is asserted, indicating a break event, it remains asserted until STPCLK# is deasserted. Assertion of PREQ# when STPCLK# is active also causes an FERR# break event.</p> <p>For additional information on the pending break event functionality, including identification of support of the feature and enable/disable information, refer to Volume 3 of the <i>Intel® 64 and IA-32 Intel® Architectures Software Developer's Manual</i> and the <i>Intel® Processor Identification and CPUID Instruction</i> application note.</p>										
GTLREF	Input	GTLREF determines the signal reference level for AGTL+ input pins. GTLREF should be set at 2/3 V <sub>CCP</sub> . GTLREF is used by the AGTL+ receivers to determine if a signal is a logical 0 or logical 1. Please refer to the appropriate platform design guide for details on GTLREF implementation.										
HIT# HITM#	Input/Output	HIT# (Snoop Hit) and HITM# (Hit Modified) convey transaction snoop operation results. Either FSB agent may assert both HIT# and HITM# together to indicate that it requires a snoop stall, which can be continued by reasserting HIT# and HITM# together.										





Table 15. Signal Description (Sheet 5 of 8)

Name	Type	Description
IERR#	Output	<p>IERR# (Internal Error) is asserted by a processor as the result of an internal error. Assertion of IERR# is usually accompanied by a SHUTDOWN transaction on the FSB. This transaction may optionally be converted to an external error signal (e.g., NMI) by system core logic. The processor keeps IERR# asserted until the assertion of RESET#, BINIT#, or INIT#.</p> <p>For termination requirements please refer to the appropriate platform design guide.</p>
IGNNE#	Input	<p>IGNNE# (Ignore Numeric Error) is asserted to force the processor to ignore a numeric error and continue to execute noncontrol floating-point instructions. If IGNNE# is deasserted, the processor generates an exception on a noncontrol floating-point instruction if a previous floating-point instruction caused an error. IGNNE# has no effect when the NE bit in control register 0 (CRO) is set.</p> <p>IGNNE# is an asynchronous signal. However, to ensure recognition of this signal following an Input/Output write instruction, it must be valid along with the TRDY# assertion of the corresponding Input/Output Write bus transaction.</p>
INIT#	Input	<p>INIT# (Initialization), when asserted, resets integer registers inside the processor without affecting its internal caches or floating-point registers. The processor then begins execution at the power-on Reset vector configured during power-on configuration. The processor continues to handle snoop requests during INIT# assertion. INIT# is an asynchronous signal. However, to ensure recognition of this signal following an Input/Output Write instruction, it must be valid along with the TRDY# assertion of the corresponding Input/Output Write bus transaction. INIT# must connect the appropriate pins of both FSB agents.</p> <p>If INIT# is sampled active on the active to inactive transition of RESET#, then the processor executes its Built-in Self-Test (BIST).</p> <p>For termination requirements please refer to the appropriate platform design guide.</p>
LINT[1:0]	Input	<p>LINT[1:0] (Local APIC Interrupt) must connect the appropriate pins of all APIC Bus agents. When the APIC is disabled, the LINT0 signal becomes INTR, a maskable interrupt request signal, and LINT1 becomes NMI, a nonmaskable interrupt. INTR and NMI are backward compatible with the signals of those names on the Intel® Pentium® processor. Both signals are asynchronous.</p> <p>Both of these signals must be software configured via BIOS programming of the APIC register space to be used either as NMI/INTR or LINT[1:0]. Because the APIC is enabled by default after Reset, operation of these pins as LINT[1:0] is the default configuration.</p>
LOCK#	Input/Output	<p>LOCK# indicates to the system that a transaction must occur atomically. This signal must connect the appropriate pins of both FSB agents. For a locked sequence of transactions, LOCK# is asserted from the beginning of the first transaction to the end of the last transaction.</p> <p>When the priority agent asserts BPRI# to arbitrate for ownership of the FSB, it waits until it observes LOCK# deasserted. This enables symmetric agents to retain ownership of the FSB throughout the bus locked operation and ensure the atomicity of lock.</p>



Table 15. Signal Description (Sheet 6 of 8)

Name	Type	Description
PRDY#	Output	Probe Ready signal used by debug tools to determine processor debug readiness. Please refer to the appropriate platform design guide for more implementation details.
PREQ#	Input	Probe Request signal used by debug tools to request debug operation of the processor. Please refer to the appropriate platform design guide for more implementation details.
PROCHOT#	Input/Output	As an output, PROCHOT# (Processor Hot) goes active when the processor temperature monitoring sensor detects that the processor has reached its maximum safe operating temperature. This indicates that the processor Thermal Control Circuit (TCC) has been activated, if enabled. As an input, assertion of PROCHOT# by the system activates the TCC, if enabled. The TCC remains active until the system deasserts PROCHOT#.
PSI#	Output	Processor Power Status Indicator signal. This signal is asserted when the processor is in a lower state (Deep Sleep).
PWRGOOD	Input	PWRGOOD (Power Good) is a processor input. The processor requires this signal to be a clean indication that the clocks and power supplies are stable and within their specifications. "Clean" implies that the signal remains low (capable of sinking leakage current), without glitches, from the time that the power supplies are turned on until they come within specification. The PWRGOOD signal must be supplied to the processor; it is used to protect internal circuits against voltage sequencing issues. It should be driven high throughout boundary scan operation. For termination requirements please refer to the appropriate platform design guide.
REQ[4:0]#	Input/Output	REQ[4:0]# (Request Command) must connect the appropriate pins of both FSB agents. They are asserted by the current bus owner to define the currently active transaction type. These signals are source synchronous to ADSTB[0]#.
RESET#	Input	Asserting the RESET# signal resets the processor to a known state and invalidates its internal caches without writing back any of their contents. For a power-on Reset, RESET# must stay active for at least two milliseconds after V <sub>CC</sub> and BCLK have reached their proper specifications. On observing active RESET#, both FSB agents deassert their outputs within two clocks. All processor straps must be valid within the specified setup time before RESET# is deasserted. Please refer to the appropriate platform design guide for termination requirements and implementation details. There is a 55-Ω (nominal) on die pull-up resistor on this signal.
RS[2:0]#	Input	RS[2:0]# (Response Status) are driven by the response agent (the agent responsible for completion of the current transaction), and must connect the appropriate pins of both FSB agents.
RSVD	Reserved /No Connect	These pins are RESERVED and must be left unconnected on the board. However, it is recommended that routing channels to these pins on the board be kept open for possible future use. Please refer to the appropriate platform design guide for more details.



Table 15. Signal Description (Sheet 7 of 8)

Name	Type	Description
SLP#	Input	SLP# (Sleep), when asserted in Stop-Grant state, causes the processor to enter the Sleep state. During Sleep state, the processor stops providing internal clock signals to all units, leaving only the Phase-Locked Loop (PLL) still operating. Processors in this state do not recognize snoops or interrupts. The processor recognizes only assertion of the RESET# signal, deassertion of SLP#, and removal of the BCLK input while in Sleep state. If SLP# is deasserted, the processor exits Sleep state and returns to Stop-Grant state, restarting its internal clock signals to the bus and processor core units. If DPSLP# is asserted while in the Sleep state, the processor exits the Sleep state and transition to the Deep Sleep state.
SMI#	Input	SMI# (System Management Interrupt) is asserted asynchronously by system logic. On accepting a System Management Interrupt, the processor saves the current state and enter System Management Mode (SMM). An SMI Acknowledge transaction is issued, and the processor begins program execution from the SMM handler. If SMI# is asserted during the deassertion of RESET# the processor tristates its outputs.
STPCLK#	Input	STPCLK# (Stop Clock), when asserted, causes the processor to enter a low-power Stop-Grant state. The processor issues a Stop-Grant Acknowledge transaction, and stops providing internal clock signals to all processor core units except the FSB and APIC units. The processor continues to snoop bus transactions and service interrupts while in Stop-Grant state. When STPCLK# is deasserted, the processor restarts its internal clock to all units and resumes execution. The assertion of STPCLK# has no effect on the bus clock; STPCLK# is an asynchronous input.
TCK	Input	TCK (Test Clock) provides the clock input for the processor Test Bus (also known as the Test Access Port). Please refer to the platform design guide for termination requirements and implementation details.
TDI	Input	TDI (Test Data In) transfers serial test data into the processor. TDI provides the serial input needed for JTAG specification support.
TDO	Output	TDO (Test Data Out) transfers serial test data out of the processor. TDO provides the serial output needed for JTAG specification support.
TEST1, TEST2, TEST3, TEST4	Input	TEST1 and TEST2 must have a stuffing option of separate pull-down resistors to V <sub>SS</sub> . For testing purposes it is recommended, but not required, to route the TEST3 and TEST4 pins through a ground referenced 55-Ω trace that ends in a via that is near a GND via and is accessible through an oscilloscope connection.
THERMDA	Other	Thermal Diode Anode.
THERMDC	Other	Thermal Diode Cathode.
THERMTRIP#	Output	The processor protects itself from catastrophic overheating by use of an internal thermal sensor. This sensor is set well above the normal operating temperature to ensure that there are no false trips. The processor stops all execution when the junction temperature exceeds approximately 125°C. This is signalled to the system by the THERMTRIP# (Thermal Trip) pin.
TMS	Input	TMS (Test Mode Select) is a JTAG specification support signal used by debug tools.



Table 15. Signal Description (Sheet 8 of 8)

Name	Type	Description
TRDY#	Input	TRDY# (Target Ready) is asserted by the target to indicate that it is ready to receive a write or implicit writeback data transfer. TRDY# must connect the appropriate pins of both FSB agents.
TRST#	Input	TRST# (Test Reset) resets the Test Access Port (TAP) logic. TRST# must be driven low during power on Reset.
V <sub>CC</sub>	Input	Processor core power supply.
V <sub>CCA</sub>	Input	V <sub>CCA</sub> provides isolated power for the internal processor core PLL's.
V <sub>CCP</sub>	Input	Processor I/O Power Supply.
V <sub>CC_SENSE</sub>	Output	V <sub>CC_SENSE</sub> together with V <sub>SS_SENSE</sub> are voltage feedback signals to Intel® MVP 6 that control the 2.1-mΩ loadline at the processor die. It should be used to sense or measure power near the silicon with little noise.
VID[6:0]	Output	VID[6:0] (Voltage ID) pins are used to support automatic selection of power supply voltages (V <sub>CC</sub> ). Unlike some previous generations of processors, these are CMOS signals that are driven by the processor. The voltage supply for these pins must be valid before the VR can supply V <sub>CC</sub> to the processor. Conversely, the VR output must be disabled until the voltage supply for the VID pins becomes valid. The VID pins are needed to support the processor voltage specification variations. See Table 2 for definitions of these pins. The VR must supply the voltage that is requested by the pins, or disable itself.
V <sub>SS_SENSE</sub>	Output	V <sub>SS_SENSE</sub> together with V <sub>CC_SENSE</sub> are voltage feedback signals to Intel MVP 6 that control the 2.1-mΩ loadline at the processor die. It should be used to sense or measure ground near the silicon with little noise.

§



## 5 Thermal Specifications

A complete thermal solution includes both component and system level thermal management features. The processor requires a thermal solution to maintain temperatures within operating limits.

**Caution:** Any attempt to operate the processor outside operating limits may result in permanent damage to the processor and potentially other components in the system.

The system/processor thermal solution should remain within the minimum and maximum junction temperature ( $T_J$ ) specifications at the corresponding thermal design power (TDP) value listed in [Table 16](#).

**Table 16. Standard Voltage Power Specifications**

Symbol	Processor Number	Core Frequency and Voltage	Die Variant	Thermal Design Power			Unit	Notes
TDP	530	1.73 GHz	1-M Fused 1 M	31			W	1, 4, 5
	540	1.86 GHz	1-M Fused 1 M	31				
	550	2.00 GHz	1-M Fused 1 M	31				
	560	2.13 GHz	1-M Fused 1M	31				
				27				
				27				
				27				
				27				
Symbol	Parameter			Min	Typ	Max	Unit	
$P_{AH}$ , $P_{SGNT}$	Auto Halt, Stop Grant Power at $V_{CC}$					10.9	W	2, 6
$P_{SLP}$	Sleep Power at $V_{CC}$					10.1	W	2, 6
$P_{DSL P}$	Deep Sleep Power at $V_{CC}$					6.8	W	2, 7
$T_J$	Junction Temperature			0		100	°C	3, 4

### NOTES:

- The TDP specification should be used to design the processor thermal solution. The TDP is not the maximum theoretical power the processor can generate.
- Not 100% tested. These power specifications are determined by characterization of the processor currents at higher temperatures and extrapolating the values for the temperature indicated.
- As measured by the activation of the on-die Intel® Thermal Monitor. The Intel Thermal Monitor's automatic mode is used to indicate that the maximum  $T_J$  has been reached. Refer to [Section 5.1](#) for more details.
- The Intel Thermal Monitor automatic mode must be enabled for the processor to operate within specifications.
- At  $T_J$  of 100°C.
- At 50°C.
- At 35°C.



The processor incorporates three methods of monitoring die temperature:

- Thermal diode
- Intel® Thermal Monitor
- Digital thermal sensor

**Note:** The Intel Thermal Monitor (detailed in [Section 5.2](#)) must be used to determine when the maximum specified processor junction temperature has been reached.

## 5.1 Thermal Diode

The processor incorporates an on-die PNP transistor whose base emitter junction is used as a thermal “diode”, with its collector shorted to Ground. The thermal diode can be read by an off-die analog/digital converter (a thermal sensor) located on the motherboard or a stand-alone measurement kit. The thermal diode may be used to monitor the die temperature of the processor for thermal management or instrumentation purposes but is not a reliable indication that the maximum operating temperature of the processor has been reached. When using the thermal diode, a temperature offset value must be read from a processor model specific register (MSR) and applied. See [Section 5.1.1](#) for more details. Please see [Section 5.2](#) for thermal diode usage recommendation when the PROCHOT# signal is not asserted.

**Note:** The reading of the external thermal sensor (on the motherboard) connected to the processor thermal diode signals do not reflect the temperature of the hottest location on the die. This is due to inaccuracies in the external thermal sensor, on-die temperature gradients between the location of the thermal diode and the hottest location on the die, and time-based variations in the die temperature measurement. Time-based variations can occur when the sampling rate of the thermal diode (by the thermal sensor) is slower than the rate at which the  $T_J$  temperature can change.

Offset between the thermal diode-based temperature reading and the Intel Thermal Monitor reading may be characterized using the Intel Thermal Monitor’s Automatic mode activation of the thermal control circuit. This temperature offset must be taken into account when using the processor thermal diode to implement power management events. This offset is different from the diode  $T_{offset}$  value programmed into the processor MSR.

[Table 17](#) to [Table 20](#) provides the diode interface and specifications. Two different sets of diode parameters are listed in [Table 19](#) and [Table 20](#). The diode model parameters apply to the traditional thermal sensors that use the diode equation to determine the processor temperature. Transistor model parameters have been added to support thermal sensors that use the transistor equation method. The transistor model may provide more accurate temperature measurements when the diode ideality factor is closer to the maximum or minimum limits. Please contact your external sensor supplier for their recommendation. The thermal diode is separate from the Intel Thermal Monitor’s thermal sensor and cannot be used to predict the behavior of the Intel Thermal Monitor.

### 5.1.1 Thermal Diode Offset

In order to improve the accuracy of the diode-based temperature measurements, a temperature offset value (specified as  $T_{offset}$ ) is programmed in the processor model-specific register (MSR) which contains thermal diode characterization data. During manufacturing each processor thermal diode is evaluated for its behavior relative to the theoretical diode. Using the equation above, the temperature error created by the difference  $n_{trim}$  and the actual ideality of the particular processor is calculated.



If the  $n_{trim}$  value used to calculate the Toffset differs from the  $n_{trim}$  value used to in a temperature sensing device, the  $T_{error(nf)}$  may not be accurate. If desired, the Toffset can be adjusted by calculating  $n_{actual}$  and then recalculating the offset using the  $n_{trim}$  as defined in the temperature sensor manufacturer's datasheet.

The  $n_{trim}$  used to calculate the Diode Correction Toffset are listed in Table 17.

**Table 17. Thermal Diode  $n_{trim}$  and Diode Correction Toffset**

Symbol	Parameter	Value
$n_{trim}$	Diode Ideality used to calculate Toffset	1.01

**Table 18. Thermal Diode Interface**

Signal Name	Pin/Ball Number	Signal Description
THERMDA	A24	Thermal diode anode
THERMDC	A25	Thermal diode cathode

**Table 19. Thermal Diode Parameters using Diode Mode**

Symbol	Parameter	Min	Typ	Max	Unit	Notes
$I_{FW}$	Forward Bias Current	5		200	$\mu A$	1
$n$	Diode Ideality Factor	1.000	1.009	1.050		2, 3, 4
$R_T$	Series Resistance	2.79	4.52	6.24	$\Omega$	2, 3, 5

**NOTES:**

- Intel does not support or recommend operation of the thermal diode under reverse bias. Intel does not support or recommend operation of the thermal diode when the processor power supplies are not within their specified tolerance range.
- Characterized across a temperature range of 50-100°C.
- Not 100% tested. Specified by design characterization.
- The ideality factor,  $n$ , represents the deviation from ideal diode behavior as exemplified by the diode equation:  

$$I_{FW} = I_s * (e^{(qV_D/nkT)} - 1)$$
 where  $I_s$  = saturation current,  $q$  = electronic charge,  $V_D$  = voltage across the diode,  $k$  = Boltzmann Constant, and  $T$  = absolute temperature (Kelvin).
- The series resistance,  $R_T$ , is provided to allow for a more accurate measurement of the diode junction temperature.  $R_T$  as defined includes the pins of the processor but does not include any socket resistance or board trace resistance between the socket and the external remote diode thermal sensor.  $R_T$  can be used by remote diode thermal sensors with automatic series resistance cancellation to calibrate out this error term. Another application is that a temperature offset can be manually calculated and programmed into an offset register in the remote diode thermal sensors as exemplified by the equation:  

$$T_{error} = [R_T * (N-1) * I_{FWmin}] / [(no/q) * \ln N]$$
 where  $T_{error}$  = sensor temperature error,  $N$  = sensor current ratio,  $k$  = Boltzmann Constant, and  $q$  = electronic charge.

**Table 20. Thermal Diode Parameters using Transistor Model**

Symbol	Parameter	Min	Typ	Max	Unit	Notes
$I_{FW}$	Forward Bias Current	5		200	$\mu\text{A}$	1, 2
$I_E$	Emitter Current	5		200	$\mu\text{A}$	1
$n_Q$	Transistor Ideality	0.997	1.001	1.005		3, 4, 5
Beta		0.3		0.760		3, 4
$R_T$	Series Resistance	2.79	4.52	6.24	$\Omega$	3, 6

**NOTES:**

- Intel does not support or recommend operation of the thermal diode under reverse bias.
- Same as  $I_{FW}$  in Table 19.
- Characterized across a temperature range of 50-100°C.
- Not 100% tested. Specified by design characterization.
- The ideality factor,  $n_Q$ , represents the deviation from ideal diode behavior as exemplified by the equation for the collector current:  

$$I_C = I_S * (e^{(qV_{BE}/n_QkT)} - 1)$$
 where  $I_S$  = saturation current,  $q$  = electronic charge,  $V_{BE}$  = voltage across the transistor base emitter junction (same nodes as VD),  $k$  = Boltzmann Constant, and  $T$  = absolute temperature (Kelvin).
- The series resistance,  $R_T$ , provided in the Diode Model Table (Table 19) can be used for more accurate readings as needed.

When calculating a temperature based on the thermal diode measurements, a number of parameters must be either measured or assumed. Most devices measure the diode ideality and assume a series resistance and ideality trim value, although are capable of also measuring the series resistance. Calculating the temperature is then accomplished using the equations listed under Table 19. In most sensing devices, an expected value for the diode ideality is designed-in to the temperature calculation equation. If the designer of the temperature sensing device assumes a perfect diode, the ideality value (also called  $n_{trim}$ ) is 1.000. Given that most diodes are not perfect, the designers usually select an  $n_{trim}$  value that more closely matches the behavior of the diodes in the processor. If the processor diode ideality deviates from that of the  $n_{trim}$ , each calculated temperature is offset by a fixed amount. This temperature offset can be calculated with the equation:

$$T_{error(nf)} = T_{measured} * (1 - n_{actual}/n_{trim})$$

Where  $T_{error(nf)}$  is the offset in degrees C,  $T_{measured}$  is in Kelvin,  $n_{actual}$  is the measured ideality of the diode, and  $n_{trim}$  is the diode ideality assumed by the temperature sensing device.

## 5.2 Intel® Thermal Monitor

The Intel Thermal Monitor helps control the processor temperature by activating the TCC (Thermal Control Circuit) when the processor silicon reaches its maximum operating temperature. The temperature at which the Intel Thermal Monitor activates the TCC is not user configurable. Bus traffic is snooped in the normal manner and interrupt requests are latched (and serviced during the time that the clocks are on) while the TCC is active.

With a properly designed and characterized thermal solution, it is anticipated that the TCC would only be activated for very short periods of time when running the most power intensive applications. The processor performance impact due to these brief periods of TCC activation is expected to be minor and hence not detectable.





**Caution:** An under-designed thermal solution that is not able to prevent excessive activation of the TCC in the anticipated ambient environment may cause a noticeable performance loss and may affect the long-term reliability of the processor. In addition, a thermal solution that is significantly under designed may not be capable of cooling the processor even when the TCC is active continuously.

The Intel Thermal Monitor controls the processor temperature by modulating (starting and stopping) the processor core clocks when the processor silicon reaches its maximum operating temperature. The Intel Thermal Monitor uses two modes to activate the TCC: Automatic mode and on-demand mode. If both modes are activated, automatic mode takes precedence.

**Note:** The Intel Thermal Monitor automatic mode must be enabled through BIOS for the processor to be operating within specifications.

The processor supports an automatic mode called Intel Thermal Monitor 1. This mode is enabled by writing values to the MSR of the processor. After automatic mode is enabled, the TCC activates only when the internal die temperature reaches the maximum allowed value for operation.

During high temperature situations, Intel Thermal Monitor 1 modulates the clocks by alternately turning the clocks off and on at a 50% duty cycle. Cycle times are processor speed-dependent and decreases linearly as processor core frequencies increase. Once the temperature has returned to a non-critical level, modulation ceases and TCC goes inactive. A small amount of hysteresis has been included to prevent rapid active/inactive transitions of the TCC when the processor temperature is near the trip point. The duty cycle is factory configured and cannot be modified. Also, automatic mode does not require any additional hardware, software drivers, or interrupt handling routines. Processor performance is decreased by the same amount as the duty cycle when the TCC is active.

The TCC may also be activated via on-demand mode. If bit 4 of the ACPI Intel Thermal Monitor control register is written to a 1, the TCC is activated immediately independent of the processor temperature. When using on-demand mode to activate the TCC, the duty cycle of the clock modulation is programmable via bits 3:1 of the same ACPI Intel Thermal Monitor control register. In automatic mode, the duty cycle is fixed at 50% on, 50% off, however in on-demand mode, the duty cycle can be programmed from 12.5% on/ 87.5% off, to 87.5% on/12.5% off in 12.5% increments. On-demand mode may be used at the same time automatic mode is enabled, however, if the system tries to enable the TCC via on-demand mode at the same time automatic mode is enabled and a high temperature condition exists, automatic mode takes precedence.

An external signal, PROCHOT# (processor hot) is asserted when the processor detects that its temperature is above the thermal trip point. Bus snooping and interrupt latching are also active while the TCC is active.

Besides the thermal sensor and thermal control circuit, the Intel Thermal Monitor also includes one ACPI register, one performance counter register, three MSR, and one I/O pin (PROCHOT#). All are available to monitor and control the state of the Intel Thermal Monitor feature. The Intel Thermal Monitor can be configured to generate an interrupt upon the assertion or deassertion of PROCHOT#.

**Note:** PROCHOT# is not asserted when the processor is in the Stop Grant, Sleep, and Deep Sleep low-power states (internal clocks stopped.). As a result, the thermal diode reading must be used as a safeguard to maintain the processor junction temperature within maximum specification. If the platform thermal solution is not able to maintain the processor junction temperature within the maximum specification, the system must initiate an orderly shutdown to prevent damage. If the processor enters one of the above low-power states with PROCHOT# already asserted, PROCHOT# remains



asserted until the processor exits the low-power state and the processor junction temperature drops below the thermal trip point.

If Intel Thermal Monitor automatic mode is disabled, the processor operates out of specification. Regardless of enabling the automatic or on-demand modes, in the event of a catastrophic cooling failure, the processor automatically shuts down when the silicon has reached a temperature of approximately 125°C. At this point the THERMTRIP# signal goes active. THERMTRIP# activation is independent of processor activity and does not generate any bus cycles. When THERMTRIP# is asserted, the processor core voltage must be shut down within the time specified in [Chapter 3](#).

### 5.3 Digital Thermal Sensor

The processor also contains an on die Digital Thermal Sensor (DTS) that can be read via a MSR (no I/O interface). The DTS is the preferred method of reading the processor die temperature since it can be located much closer to the hottest portions of the die and can thus more accurately track the die temperature and potential activation of processor core clock modulation via the Intel Thermal Monitor. The DTS is only valid while the processor is in the normal operating state (C0 state).

Unlike traditional thermal devices, the DTS outputs a temperature relative to the maximum supported operating temperature of the processor ( $T_{J,max}$ ). It is the responsibility of software to convert the relative temperature to an absolute temperature. The temperature returned by the digital thermal sensor is always at or below  $T_{J,max}$ . Over temperature conditions are detectable via an Out Of Spec status bit. This bit is also part of the DTS MSR. When this bit is set, the processor is operating out of specification and immediate shutdown of the system should occur. The processor operation and code execution is not guaranteed once the activation of the Out of Spec status bit is set.

The DTS relative temperature readout corresponds to an Intel Thermal Monitor 1 trigger point. When the DTS indicates maximum processor core temperature has been reached the Intel Thermal Monitor 1 hardware thermal control mechanism activates. The DTS and Intel Thermal Monitor 1 temperature may not correspond to the thermal diode reading since the thermal diode is located in a separate portion of the die. Additionally, the thermal gradient from DTS to thermal diode can vary substantially due to changes in processor power, mechanical and thermal attach and software application. The system designer is required to use the DTS to guarantee proper operation of the processor within its temperature operating specifications.

Changes to the temperature can be detected via two programmable thresholds located in the processor MSRs. These thresholds have the capability of generating interrupts via the core's APIC. Refer to the *Intel® 64 and IA-32 Intel® Architectures Software Developer's Manual* for specific register and programming details.

### 5.4 Out of Specification Detection

Overheat detection is performed by monitoring the processor temperature and temperature gradient. This feature is intended for graceful shut down before the THERMTRIP# is activated. If the processor's Intel Thermal Monitor 1 is triggered and the temperature remains high, an Out Of Spec status and sticky bit are latched in the status MSR register and generates a thermal interrupt.



## 5.5 PROCHOT# Signal Pin

An external signal, PROCHOT# (processor hot), is asserted when the processor die temperature has reached its maximum operating temperature. If the Intel Thermal Monitor 1 is enabled (note that the Intel Thermal Monitor 1 must be enabled for the processor to be operating within specification), the TCC is active when PROCHOT# is asserted. The processor can be configured to generate an interrupt upon the assertion or deassertion of PROCHOT#.

The processor implements a bi-directional PROCHOT# capability to allow system designs to protect various components from over-heating situations. The PROCHOT# signal is bi-directional in that it can either signal when the processor has reached its maximum operating temperature or be driven from an external source to activate the TCC. The ability to activate the TCC via PROCHOT# can provide a means for thermal protection of system components.

One application for the PROCHOT# signal is the thermal protection of voltage regulators (VR). System designers can create a circuit to monitor the VR temperature and activate the TCC when the temperature limit of the VR is reached. By asserting PROCHOT# (pulled-low) and activating the TCC, the VR can cool down as a result of reduced processor power consumption. Bi-directional PROCHOT# can allow VR thermal designs to target maximum sustained current instead of maximum current. Systems should still provide proper cooling for the VR, and rely on bi-directional PROCHOT# only as a backup in case of system cooling failure. The system thermal design should allow the power delivery circuitry to operate within its temperature specification even while the processor is operating at its TDP. With a properly designed and characterized thermal solution, it is anticipated that bi-directional PROCHOT# would only be asserted for very short periods of time when running the most power-intensive applications. An under-designed thermal solution that is not able to prevent excessive assertion of PROCHOT# in the anticipated ambient environment may cause a noticeable performance loss.

§