

Intel[®] RAID Controller SRCASBB8I Hardware User's Guide

Intel Order Number: E33166-001

INFORMATION IN THIS DOCUMENT IS PROVIDED IN CONNECTION WITH INTEL(R) PRODUCTS. NO LICENSE, EXPRESS OR IMPLIED, BY ESTOPPEL OR OTHERWISE, TO ANY INTELLECTUAL PROPERTY RIGHTS IS GRANTED BY THIS DOCUMENT. EXCEPT AS PROVIDED IN INTEL'S TERMS AND CONDITIONS OF SALE FOR SUCH PRODUCTS, INTEL ASSUMES NO LIABILITY WHATSOEVER, AND INTEL DISCLAIMS ANY EXPRESS OR IMPLIED WARRANTY, RELATING TO SALE AND/OR USE OF INTEL PRODUCTS INCLUDING LIABILITY OR WARRANTIES RELATING TO FITNESS FOR A PARTICULAR PURPOSE, MERCHANTABILITY, OR INFRINGEMENT OF ANY PATENT, COPYRIGHT OR OTHER INTELLECTUAL PROPERTY RIGHT. Intel products are not intended for use in medical, life saving, life sustaining applications. Intel may make changes to specifications and product descriptions at any time, without notice.

Intel is a trademark or registered trademark of Intel Corporation or its subsidiaries in the United States and other countries.

*Other names and brands may be claimed as the property of others.

Copyright © 2007-2008 by Intel Corporation. Portions Copyright 2005-2008 by LSI Logic Corporation. All rights reserved.

Preface

This is the primary hardware guide for the Intel® RAID Controller SRCASBB8I, which can be used for SAS and SATA disk drives. It contains installation instructions and specifications.

For details on how to configure the storage adapters, and for an overview of the software drivers, see the *Software User's Guide* on the Resource CD.

Audience

This document assumes that you have some familiarity with RAID controllers and related support devices. The people who benefit from this book are:

- Engineers who are designing an Intel® RAID Controller SRCASBB8I storage adapter for a system.
- Anyone installing an Intel® RAID Controller SRCASBB8I storage adapter in a RAID system.

Organization

This document includes the following chapters and appendixes:

- Chapter 1 provides a general overview of the Intel® RAID Controller SRCASBB8I.
- Chapter 2 describes the procedures for installing the RAID controller.
- Chapter 3 provides the characteristics and technical specifications for the Intel® RAID Controller SRCASBB8I.
- Appendix A explains drive roaming and how to do a drive migration.

Related Publication

The *Software User's Guide* is on the Resource CD that ships with the RAID controller.

Contents

Preface	iii
Audience	iii
Organization	iii
Related Publication	iii
Chapter 1, Overview	1
Benefits of SAS	1
Intel® RAID Controller SRCASBB8I	2
Protocol Support	2
Operating System Support	2
Usability	2
Redundancy and Error Handling	3
SAS/SATA Features of the 1078 Controller	4
Beep Codes	5
Chapter 2, Intel® RAID Controller SRCASBB8I Hardware Installation	7
Requirements	7
Install the RAID Controller	7
Configure the RAID Controller	10
Replacing a Controller, Resolving a Config Mismatch	10
Chapter 3, Intel® RAID Controller SRCASBB8I Characteristics	11
Technical Specifications	12
Array Performance Features	13
Fault Tolerance	13
Electrical Characteristics	14
Safety Characteristics	14
A. Drive Roaming and Drive Migration Install	15
Drive Roaming	15
Drive Migration	16
B. Installation / Assembly Safety Instructions	17
English	19
Deutsch	20
Français	22
Español	23
Italiano	24
C. Regulatory and Certification Information	27
Electromagnetic Compatibility Notices	29

1 Overview

The Intel® RAID Controller SRCASBB8I is a high-performance intelligent PCI-Express* SAS/SATA RAID controller that offers reliability, high performance, and fault-tolerant disk subsystem management. This is a RAID solution that meets the internal storage needs of workgroup, department, or enterprise systems to use cost-effective SATA or high performance SAS media.

As a third generation PCI Express storage controller, the Intel® RAID Controller SRCASBB8I addresses the demand for increased data throughput and scalability requirements across entry level and midrange and enterprise server platforms.

The controller can be connected to up to eight drives directly and allows the use of expanders to connect to additional drives. See the ANSI SAS standard, version 1.0 specification for more information about the use of expanders.

SATA and SAS are serial, point-to-point, device interfaces that use simplified cabling, smaller connectors, lower pin counts, and lower power requirements than parallel SCSI.

The optional Intel® RAID Smart Battery AXRSBBU6 provides cached data protection for the RAID controller, even during system failures.

Benefits of SAS

SAS is a serial, point-to-point, enterprise-level device interface that leverages the proven SCSI protocol set. SAS is a convergence of the advantages of SATA, SCSI, and FC, and is the future mainstay of the enterprise and high-end workstation storage markets. SAS offers a higher bandwidth per pin than parallel SCSI and improves signal and data integrity.

The SAS interface uses the proven SCSI command set to ensure reliable data transfers, while providing the connectivity and flexibility of point-to-point serial data transfers. The serial transmission of SCSI commands eliminates clock skew challenges. The SAS interface provides improved performance, simplified cabling, smaller connectors, lower pin count, and lower power requirements than parallel SCSI.

SAS controllers leverage a common electrical and physical connection interface that is compatible with Serial ATA technology. The SAS and SATA protocols use a thin, 7-wire connector instead of the 68-wire SCSI cable or 40-wire ATA cable. The SAS/SATA connector and cable are easier to manipulate, connect to smaller devices, and do not inhibit airflow. The point-to-point SATA architecture eliminates difficulties created by the legacy ATA master-slave architecture, while maintaining compatibility with existing ATA firmware.

Intel® RAID Controller SRCASBB8I

The Intel® RAID Controller SRCASBB8I is an intelligent low-profile RAID adapter with an integrated LSI* 1078 RAID-On-Chip chipset, providing both a SAS controller and RAID engine. With 256 MB RAM built onto the board and eight independent ports using two SFF-8087 mini multi-lane connectors, this controller supports up to 32 enterprise-class SAS or SATA devices and 64 logical drives. The PCI-Express* connector fits into an x8 or x16 PCI-Express slot capable of 2.5 Gbps per lane over PCI Express* x4 with a 3.0 Gbps point to point transfer rate.

The SAS controller supports the ANSI Serial Attached SCSI (SAS) standard, version 1.0 and the Serial ATA (SATA) protocol defined by the Serial ATA specification, version 1.0a.

Protocol Support

- Serial SCSI Protocol (SSP): Communication with other SAS devices.
- SATA II Protocol: Communication with other SATA II devices.
- Serial Management Protocol (SMP): Topology management information sharing with expanders.
- Serial Tunneling Protocol (STP) support for SATAII through expander interfaces.

Operating System Support

- Windows Server 2003*, Windows 2000* Enterprise Server, SP4 and Windows XP*.
- Red Hat* Enterprise Linux 3.0, 4.0, and 5.0.
- SuSE* Linux Enterprise Server 9, SP1-3 and SLES 10.

The operating systems supported may not be supported by your server board. See the tested operating system list for your server board at <http://support.intel.com/support/motherboards/server/>. See also the tested hardware and operating system list for the Intel® RAID Controller SRCASBB8I to make sure the RAID card supports your operating system.

Usability

- The card ships with both a standard and a low-profile bracket.
- Small, thin cabling with serial point-to-point 3.0 Gbps data transfer rates.
- Support for non-disk devices and mixed capacity drives.
- Support for intelligent XOR RAID levels 0, 1, 5, 6, 10, 50, and 60.
- Dedicated or global hot spare with auto rebuild if an array drive fails.
- User defined stripe size per drive: 8, 16, 32, 64 (def), 128, 256, 512, or 1024 KB.

- Advanced Array configuration and Management Utilities provides:
 - Online Capacity Expansion (OCE) adds space to existing drive or new drive. See Appendix A for limitations on OCE and RAID migration.
 - Online RAID level migration (upgrade of RAID mode, may require OCE).
 - Drive migration.
 - Drive roaming.
 - No reboot necessary after expansion.
- Upgradeable Flash ROM interface.
- Allows for staggered spin up, hot-plug, and lower power consumption.
- User specified rebuild rate (percent of system resources to use from 0-100%).

Caution: *Exceeding 50% rate may cause operating system errors due to waiting for controller access.*

- Background operating mode can be set for Rebuilds, Consistency Checks, Initialization (auto restarting Consistency Check on redundant volumes); Migration, OCE, and Patrol Read.

Redundancy and Error Handling

- In-band and out-of-band SES2.
- Enclosure management support.
- Fault indicators per drive.
- Drive coercion (auto-resizing to match existing disks).
- Auto-detection of failed drives with transparent rebuild. There must be disk activity (I/O to the drive) for a missing drive to be marked as failed.
- Auto-resume on reboot of initialization or rebuild (must be enabled before virtual disk creation).
- Smart initialization automatically checks consistency of virtual disks if there are five or more disks in a RAID 5 array, which optimizes performance by enabling read-modify-write mode. RAID 5 arrays of only three or four drives use Peer Read mode.
- Dirty cache LED plus error reporting for cache write to disk.
- Smart Technology predicts failures of drives and electronic components.
- Patrol Read checks drives and maps bad sectors.
- Commands are retried at least four times.
- Firmware provides best effort to recognize an error and recover if possible.
- Failures are logged from controller and drive firmware, and SMART monitor.
- Failures are logged in NVRAM, viewable from OS Event Log, Intel® RAID Web Console 2; CIM, LEDs, and via alarm.

- Multiple cache options allow configuration-specific performance optimization:
 - Write-back. Faster because it does not wait for the disk but data will be lost if power is lost.
 - Write-through. Usually slower but ensures data is on the disk.
 - Read Ahead. Predicts next read will be sequential and buffers this data into the cache.
 - Non Read Ahead. Always reads from the drive after determining exact location of each read.
 - Adaptive Read Ahead. Reads ahead and caches data only if doing sequential reads.
 - I/O setting. Determines whether read operations check the cache before reading from disks.
 - ✧ Cache I/O: Checks cache first, only reads disk if data is not in the cache.
 - ✧ Direct I/O: Reads data directly from disk. (not cache)
- Redundancy through:
 - Configuration stored in nonvolatile RAM and on the drives (COD).
 - Hot-swap support.
 - Optional battery backup for cache memory. Controller provides fast or trickle charges.

SAS/SATA Features of the 1078 Controller

- Provides eight independent phys, each supporting 3.0 Gbps SATA data transfers.
- Scalable interface that supports up to 32 physical devices and 64 logical devices via expanders.
- Supports SSP to enable communication with other SAS devices.
- Supports SMP to communicate topology management information.
- Supports single PHY or wide ports consisting of 2, 3, or 4 PHY within one quad port.
- Allows addressing of multiple SATA targets through an expander if using SATA 2.0-compliant hard disk drives.
- Allows multiple initiators to address a single target (in a fail-over configuration) through an expander.

Online Capacity Expansion and RAID Level Migration Rules

- Migration must occur to the same or larger capacity configuration.
- Migration cannot occur if there is more than one virtual disk in a logical array.
- Migration and OCE cannot be done on Spanned Arrays (RAID 10, 50, 60).
- Migrations supported are : RAID 1 to RAID 0, RAID 5 to RAID 0, RAID 6 to RAID 0.
- With OCE migrations supported are RAID 0 to RAID 1, RAID 0 to RAID 5, RAID 1 to RAID 5.

Beep Codes

- Short beep, 1 second on, 1 second off. Array is degraded but no data lost.
- Long beep, 3 seconds on, 1 second off. Array has failed. Data has been lost.
- Short beep, 1 second on, 3 seconds off. Using hot spare in rebuild. Alarm will continue during rebuild with a different sound at completion.

To disable the alarm, choose Disable Alarm. To enable alarm, choose Enable Alarm

To disable alarm only until the next event or until next power cycle, choose Silence Alarm.

2 Intel® RAID Controller SRCASBB8I Hardware Installation

Requirements

- The Intel® RAID Controller SRCASBB8I, with the provided cables.
- A host system with an available x8 or x16 PCI-Express* slot.
- The Resource CD, which contains drivers and documentation.
- SAS or SATA 3.0 hard drives.

Note: Intel Corporation strongly recommends using an uninterruptible power supply (UPS).

Install the RAID Controller

1. Turn off the power to the system and all drives, enclosures, and system components. Remove the power cord(s).
2. Follow the instructions that came with your server system to remove the server cover.
3. If necessary, change the bracket on the RAID controller to fit the height of the server system. See the following figure.

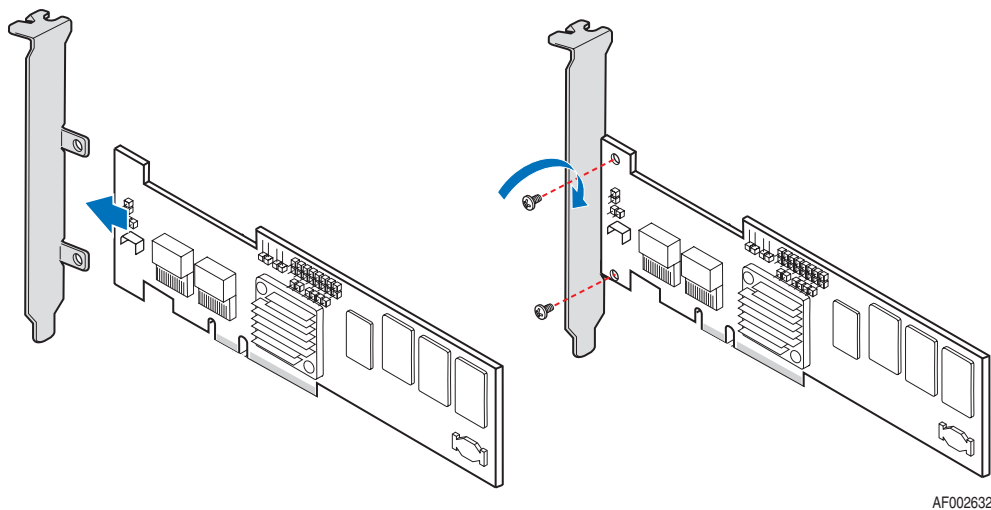

Figure 1. Changing the Bracket

4. Install the RAID controller into an available server system x8 or x16 PCI-Express* slot. See your server system documentation to locate an appropriate slot and for instructions on installing an add-in card. See also the following figure.

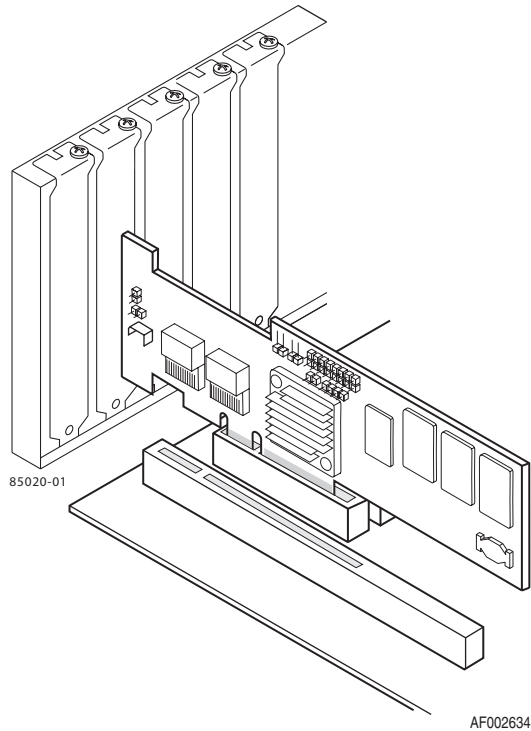
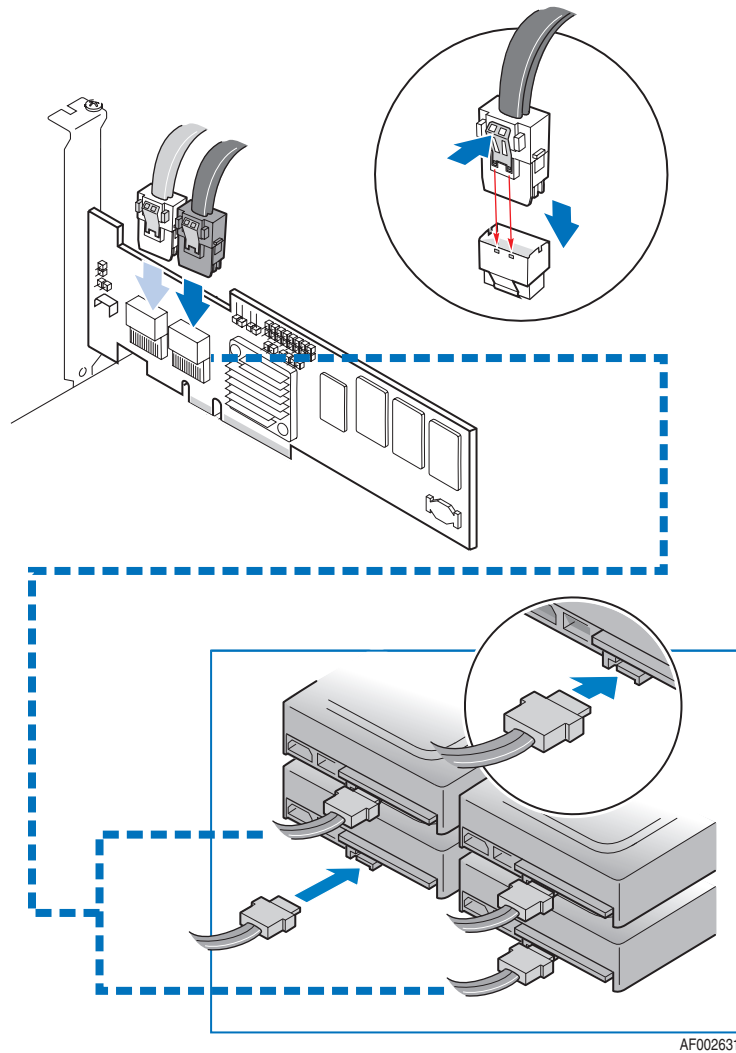

Figure 2. Installing the Intel® RAID Controller SRCASBB8

5. For the first four drives, ports 0 - 3, connect one 4-port combined end of an internal cable to the right connector. If you are using more than four drives without using an expander backplane, connect the second cable to the left connector. See the following figure.

To prevent throughput problems, use the cables provided or use the shortest possible cable. Do not use cables longer than one meter. Decrease the maximum length by one foot if using a backplane. Do not use cross-over cables. Only connect to a SATA drive, SAS or SATA backplane, or an expander device. Route the cables carefully. Check that controller and cables are all properly attached.



AF002631

Figure 3. Connecting Cables between the RAID Controller and Drives/Backplane

6. Install the server system cover and connect the power cords. See your server system documentation for instructions.

Configure the RAID Controller

1. Turn on the system power and listen to be sure that the SATA devices power up before or at the same time as the system.
2. During the boot, a BIOS message displays to state the keys to press to enter the Intel[®] RAID BIOS Console 2, such as
`Press <CTRL><G> to run BIOS Console 2.`
This message times out after several seconds. If you miss it, you need to restart the system.
After you press the keys to enter the Intel[®] RAID BIOS Console 2 software, the firmware takes several seconds to initialize and then display the Intel[®] RAID Controller SRCASBB8I number and firmware version. The numbering of the RAID controller follows the PCI slot scanning order used by the server board.
3. See the *Quick Start User's Guide* and the *Software User's Guide* for instructions to configure the RAID controller and to install the operating system drivers.

Replacing a Controller, Resolving a Config Mismatch

To replace the RAID controller, see your server system documentation for instructions to remove and then install an add-in adapter.

If the newly installed RAID controller was previously configured, a message displays during POST, stating that there is a configuration mismatch because the configuration data in the NVRAM differs from that in the hard drives. Use these steps to resolve the mismatch:

1. Press <Ctrl> + <G> when prompted during boot up to access the BIOS Configuration Utility.
2. Select `Configure > View/Add Configuration` to see the NVRAM and drive configurations.
3. Since the drives contain the correct configuration, use configuration from the disks.
4. Press <Esc> and select YES to update the NVRAM.
5. Exit and reboot.

3 Intel® RAID Controller SRCASBB8I Characteristics

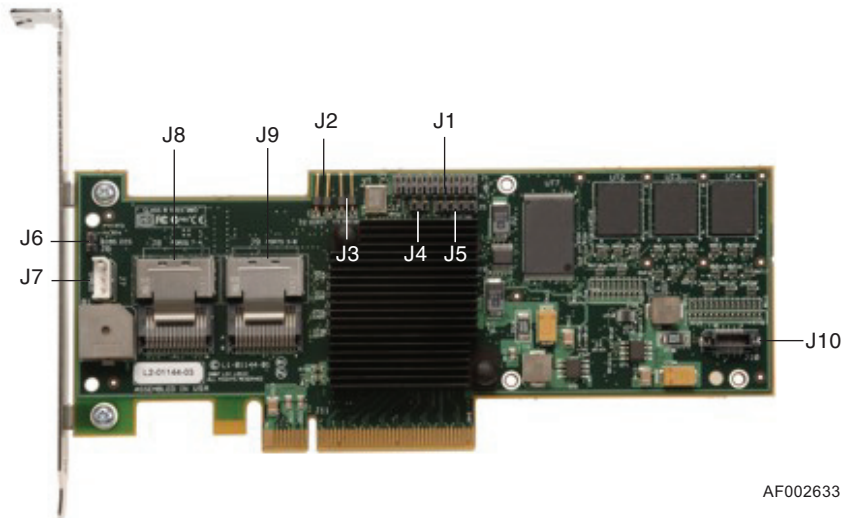

Figure 4. Card Layout

Jumper	Description	Type	Comments
J1	Drive Fault LED Header	8x2 header	LED signal support for front panel drive fault per port.
J2	Dirty Cache LED Header	2-pin connector	For connection to enclosure LED. When lit, indicates the data in the cache has not been written to disk.
J3	Drive Activity LED Header	2-pin connector	LED signal for drive activity.
J4	Debug Connector	2-pin connector	Reserved
J5	Universal Asynchronous Receiver/Transmitter (UART)	4-pin connector	For factory and debug use.
J6	Mode 0 Select	2-pin connector	<p>No jumper is required for normal operation. Setting the controller to Mode 0 holds the I/O processor in reset for firmware recovery.</p> <ul style="list-style-type: none"> • No jumper = Normal operational mode. • Jumper = Mode 0 for firmware recovery; requires a firmware recovery utility and firmware image file.

Jumper	Description	Type	Comments
J7	Keyed I ² C Connector	3-pin keyed connector	Out-of-band enclosure management (SES2)
J8	Internal SAS/SATA Port Connector, Ports 4-7	SFF8087	Connection to SAS/SATA devices.
J9	Internal SAS/SATA Port Connector, Ports 0-3	SFF8087	Connection to SAS/SATA devices.
J10	Board-to-board connector for battery backup unit	20-pin connector	Provides an interface to the daughter card that contains the battery backup unit.

Technical Specifications

Specification	Intel® RAID Controller SRCASBB8I
Processor	LSI* 1078 Integrated RAID on Chip 500 MHz
Operating voltage	+3.3 V, +12 V
Card size	Low profile, extended half-length (6.6-inch, MD2)
Array interface to host	PCI Express* Rev 1.0A, x8 lane width 2.5 Gbps
SATA bus speed	3 Gbps per port, point-to-point
Serial port	3-pin RS232-compatible connector for debug use only
SAS controller	LSI 1078
SAS/SATA ports	2x4 internal ports, 16 devices per port with expanders
Physical and virtual drive support	32 physical drives, 64 virtual drives, and 16 RAID arrays per controller
Cache	256 MBs DDR2 667 MHz SDRAM, optional battery backup
Firmware	4 M in reflashable flash ROM
Compatible devices	2.5-inch and 3.5-inch SAS or SATA 3.0 drives; non disk devices including expanders. Can support drives of mixed capacity.
Cabling	Small, thin cables do not restrict airflow; Shared connectors for multiple drives
Redundant configuration	32 Kb NVRAM and config-on-disk (COD)
Enclosure management	in-band and out-of-band
Enclosure support	Assumes one SEP per enclosure

Array Performance Features

Host data transfer rate	2.5 Gigabit/s per PCI Express* lane
Drive data transfer rate	3 Gigabit/s per lane
Maximum scatter / gather	26 elements
Maximum size of I/O requests	6.4 Mbytes in 64 Kbyte stripes
Max queue tags per drive	As many as the drive can accept
Stripe sizes	8, 16, 32, 64, 128, 256, 512, or 1024 KB
Max concurrent commands	255
Support for multiple initiators	Yes
Performance	Native command queuing
Flexibility	Drive migration, RAID level migration, Drive Roaming, Online Capacity Expansion - without reboot
Background services	Rebuild, Consistency Check, Migration, OCE, and Patrol Read
Cache options	Write-back or Write-through Read Ahead, Adaptive Read Ahead, NonRead Ahead, Cache I/O or Direct I/O

Fault Tolerance

Self Monitoring Analysis and Reporting Technology (SMART) support	Detects up to 70% of predictable disk drive failures and monitors the internal performance of all motors, heads, and drive electronics.
Optional Battery Backup	Intel® RAID Smart Battery AXXRSBBU6 cache backup. Up to 72 hours of data retention. "Gas Gauge".
Drive Replacement	Auto detection of failure, hot plug, hot swap.
Drive Rebuild Using Hot Spares	Automatic at fail: Dedicated per Array; Global for any array; Auto-resume of initialization or rebuild on reboot
Error Checking and Indication	Parity generation and checking, automatic consistency checking; patrol reads; activity and fault LEDs, alarm; multiple retries; logs in NVRAM, event log, CIM, Smart, Intel® RAID Web Console 2

Electrical Characteristics

PCI +12 V	PCI +3.3 Aux	PCI +3.3 V	Temperatures	Other
1.0-1.81A	30mA	330mA	0C to 40C with battery. 0 to 50C without battery Non-operating, no battery -30C to +80C	Airflow > 200 LFPM relative humidity non-condensing: 5%-90%. With battery 20-80% 10-90% condensing

Safety Characteristics

The Intel® RAID Controller SRCSASBB8I meets or exceeds the requirements of UL flammability rating 94 V0. Each bare board is marked with the supplier name or trademark, type, and UL flammability rating. For the boards installed in a PCI bus slot, all voltages are lower than the SELV 42.4 V limit.

Appendix A: Drive Roaming and Drive Migration Install

Drive Roaming

Drive roaming occurs when the hard drives are changed to different ports on the same controller. When the drives are placed on different ports, the controller detects the RAID configuration from the configuration data on the drives.

Note: *If you move a drive that is currently being rebuilt, the rebuild operation will restart, not resume.*

To use drive roaming:

1. Turn off the power to the system and all drives, enclosures, and system components. Remove the power cord(s).
2. Follow the instructions that came with your server system to remove the server cover.
3. Move the drives to different positions on the backplane to change the targets. See your server documentation for instructions to install and remove drives.
4. Determine the target requirements.
5. Make sure the drives are inserted properly.
6. Follow the instructions that came with your server system to remove the server cover.
7. Plug in and power on the system.

The controller detects the RAID configuration from the configuration data on the drives (COD).

Drive Migration

Drive migration moves a configured set of hard drives from one controller to another. The drives must remain on the same port and be reinstalled in the same order as in the original configuration. The controller to which you migrate the drives cannot have an existing configuration.

Note: *Only complete configurations can be migrated; individual virtual disks cannot be migrated. Drive roaming and drive migration cannot be supported at the same time.*

To migrate drives:

1. Clear the configuration on the system to which you migrate the drives. This prevents a configuration data mismatch between the hard drives and the NVRAM.
2. Turn off the power to the system and all drives, enclosures, and system components. Remove the power cord(s).
3. Follow the instructions that came with your server system to remove the server cover.
4. Disconnect the cables from the drives to be migrated.
5. Remove the hard drives from the first system and install them into the second system. See your server documentation for instructions to install and remove drives.
6. Connect the data cables to the hard drives in the second system in the same order as they were connected in the first system. Make sure all the cables meet specifications.
7. Determine the drive target requirements.
8. Make sure all cables are properly attached and the RAID controller is properly installed.
9. Follow the instructions that came with your server system to remove the server cover.
10. Plug in and power on the system.

When you start the system, the controller detects the RAID configuration from the configuration data on the drives.

Appendix B: Installation / Assembly Safety Instructions

As you use your computer system, observe these safety guidelines:

- Do not operate your computer system with any cover(s) (such as computer covers, bezels, filler brackets, and front-panel inserts) removed:
- To help avoid damaging your computer, be sure the voltage selection switch on the power supply is set to match the alternating current (AC) power available at your location.
- To help avoid possible damage to the server board, wait five seconds after turning off the system before removing a component from the server board or disconnecting a peripheral device from the computer.
- To help prevent electric shock, plug the computer and peripheral power cables into properly grounded power sources. These cables are equipped with 3-prong plugs to ensure proper grounding. Do not use adapter plugs or remove the grounding prong from a cable. If you must use an extension cable, use a 3-wire cable with properly grounded plugs.
- To help protect your computer system from sudden, transient increases and decreases in electrical power, use a surge suppressor, line conditioner, or uninterruptible power supply.
- Be sure nothing rests on your computer system's cables and that the cables are not located where they can be stepped on or tripped over.
- Do not spill food or liquids on your computer. If the computer gets wet, consult the documentation that came with it.
- Do not push any objects into the openings of your computer. Doing so can cause fire or electric shock by shorting out interior components.
- Keep your computer away from radiators and heat sources. Also, do not block cooling vents. Avoid placing loose papers underneath your computer; do not place your computer in a closed-in wall unit or on a rug.

When working inside your computer:

- Do not attempt to service the computer system yourself, except as explained in this guide and elsewhere in Intel documentation. Always follow installation and service instructions closely.
- Turn off your computer and any peripherals.
- Disconnect your computer and peripherals from their power sources. Also disconnect any telephone or telecommunications lines from the computer.
- Doing so reduces the potential for personal injury or shock.

Additional safety guidelines:



- When you disconnect a cable, pull on its connector or on its strain-relief loop, not on the cable itself. Some cables have a connector with locking tabs; if you are disconnecting this type of cable, press in on the locking tabs before disconnect the cable. As you pull connectors apart, keep them evenly aligned to avoid bending any connector pins. Also, before you connect a cable, make sure both connectors are correctly oriented and aligned.
- Handle components and cards with care. Don't touch the components or contacts on a card. Hold a card by its edges or by its metal mounting bracket. Hold a component such as a microprocessor chip by its edges, not by its pins.

Protecting against electrostatic discharge

- Static electricity can harm delicate components inside your computer. To prevent static damage, discharge static electricity from your body before you touch any of your computer's electronic components, such as the microprocessor. You can do so by touching an unpainted metal surface, such as the metal around the card-slot openings at the back of the computer.
- As you continue to work inside the computer, periodically touch an unpainted metal surface to remove any static charge your body may have accumulated. In addition to the preceding precautions, you can also take the following steps to prevent damage from electrostatic discharge (ESD):
- When unpacking a static-sensitive component from its shipping carton, do not remove the component from the antistatic packing material until you are ready to install the component in your computer. Just before unwrapping the antistatic packaging, be sure to discharge static electricity from your body.
- When transporting a sensitive component, first place it in an antistatic container or packaging.
- Handle all sensitive components in a static-safe area. If possible, use antistatic floor pads and workbench pads.

English

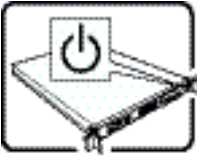
Read all caution and safety statements in this document before performing any of the instructions. See also Intel Server Boards and Server Chassis Safety Information on the Resource CD and/or at <http://support.intel.com/support/motherboards/server/sb/cs-010770.htm>.

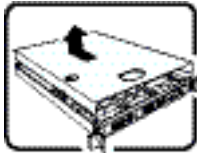
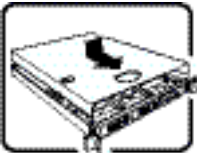
	<p>The power button on the system does not turn off system AC power. To remove AC power from the system, you must unplug each AC power cord from the wall outlet or power supply.</p> <p>The power cord(s) is considered the disconnect device to the main (AC) power. The socket outlet that the system plugs into shall be installed near the equipment and shall be easily accessible.</p>
	<p>SAFETY STEPS: Whenever you remove the chassis covers to access the inside of the system, follow these steps:</p> <ol style="list-style-type: none"> 1. Turn off all peripheral devices connected to the system. 2. Turn off the system by pressing the power button. 3. Unplug all AC power cords from the system or from wall outlets. 4. Label and disconnect all cables connected to I/O connectors or ports on the back of the system. 5. Provide some electrostatic discharge (ESD) protection by wearing an antistatic wrist strap attached to chassis ground of the system-any unpainted metal surface-when handling components. 6. Do not operate the system with the chassis covers removed.
	<p>After you have completed the six SAFETY steps above, you can remove the system covers. To do this:</p> <ol style="list-style-type: none"> 1. Unlock and remove the padlock from the back of the system if a padlock has been installed. 2. Remove and save all screws from the covers. 3. Remove the cover(s).
	<p>For proper cooling and airflow, always reinstall the chassis covers before turning on the system. Operating the system without the covers in place can damage system parts. To install the covers:</p> <ol style="list-style-type: none"> 1. Check first to make sure you have not left loose tools or parts inside the system. 2. Check that cables, add-in cards, and other components are properly installed. 3. Attach the covers to the chassis with the screws removed earlier, and tighten them firmly. 4. Insert and lock the padlock to the system to prevent unauthorized access inside the system. 5. Connect all external cables and the AC power cord(s) to the system.

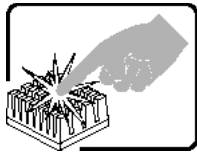

A microprocessor and heat sink may be hot if the system has been running. Also, there may be sharp pins and edges on some board and chassis parts. Contact should be made with care. Consider wearing protective gloves.

Deutsch

Lesen Sie zunächst sämtliche Warn- und Sicherheitshinweise in diesem Dokument, bevor Sie eine der Anweisungen ausführen. Beachten Sie hierzu auch die Sicherheitshinweise zu Intel-Serverplatinen und -Servergehäusen auf der Ressourcen-CD oder unter <http://support.intel.com/support/motherboards/server/sb/cs-010770.htm>.

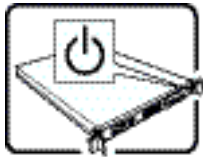

Der Wechselstrom des Systems wird durch den Ein-/Aus-Schalter für Gleichstrom nicht ausgeschaltet. Ziehen Sie jedes Wechselstrom-Netzkabel aus der Steckdose bzw. dem Netzgerät, um den Stromanschluß des Systems zu unterbrechen.



SICHERHEISSMASSNAHMEN: Immer wenn Sie die Gehäuseabdeckung abnehmen um an das Systeminnere zu gelangen, sollten Sie folgende Schritte beachten:

1. Schalten Sie alle an Ihr System angeschlossenen Peripheriegeräte aus.
2. Schalten Sie das System mit dem Hauptschalter aus.
3. Ziehen Sie den Stromanschlußstecker Ihres Systems aus der Steckdose.
4. Auf der Rückseite des Systems beschrifteten und ziehen Sie alle Anschlußkabel von den I/O Anschlüssen oder Ports ab.
5. Tragen Sie ein geerdetes Antistatik Gelenkband, um elektrostatische Ladungen (ESD) über blanke Metallstellen bei der Handhabung der Komponenten zu vermeiden.
6. Schalten Sie das System niemals ohne ordnungsgemäß montiertes Gehäuse ein.

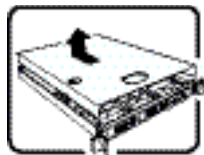

SICHERHEISSMASSNAHMEN: Immer wenn Sie die Gehäuseabdeckung abnehmen um an das Systeminnere zu gelangen, sollten Sie folgende Schritte beachten:

1. Schalten Sie alle an Ihr System angeschlossenen Peripheriegeräte aus.
2. Schalten Sie das System mit dem Hauptschalter aus.
3. Ziehen Sie den Stromanschlußstecker Ihres Systems aus der Steckdose.
4. Auf der Rückseite des Systems beschrifteten und ziehen Sie alle Anschlußkabel von den I/O Anschlüssen oder Ports ab.
5. Tragen Sie ein geerdetes Antistatik Gelenkband, um elektrostatische Ladungen (ESD) über blanke Metallstellen bei der Handhabung der Komponenten zu vermeiden.
6. Schalten Sie das System niemals ohne ordnungsgemäß montiertes Gehäuse ein.

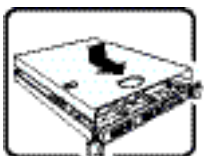

Zur ordnungsgemäßen Kühlung und Lüftung muß die Gehäuseabdeckung immer wieder vor dem Einschalten installiert werden. Ein Betrieb des Systems ohne angebrachte Abdeckung kann Ihrem System oder Teile darin beschädigen. Um die Abdeckung wieder anzubringen:

1. Vergewissern Sie sich, daß Sie keine Werkzeuge oder Teile im Innern des Systems zurückgelassen haben.
2. Überprüfen Sie alle Kabel, Zusatzkarten und andere Komponenten auf ordnungsgemäßen Sitz und Installation.
3. Bringen Sie die Abdeckungen wieder am Gehäuse an, indem Sie die zuvor gelösten Schrauben wieder anbringen. Ziehen Sie diese gut an.
4. Bringen Sie die Verschlusseinrichtung (Padlock) wieder an und schließen Sie diese, um ein unerlaubtes Öffnen des Systems zu verhindern.
5. Schließen Sie alle externen Kabel und den AC Stromanschlußstecker Ihres Systems wieder an.

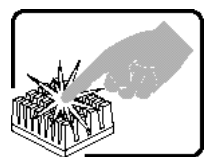

Der Mikroprozessor und der Kühler sind möglicherweise erhitzt, wenn das System in Betrieb ist. Außerdem können einige Platinen und Gehäuseteile scharfe Spitzen und Kanten aufweisen. Arbeiten an Platinen und Gehäuse sollten vorsichtig ausgeführt werden. Sie sollten Schutzhandschuhe tragen.

Français

Lisez attention toutes les consignes de sécurité et les mises en garde indiquées dans ce

	<p>Notez que le commutateur CC de mise sous tension /hors tension du panneau avant n'éteint pas l'alimentation CA du système. Pour mettre le système hors tension, vous devez débrancher chaque câble d'alimentation de sa prise.</p>
	<p>CONSIGNES DE SÉCURITÉ -Lorsque vous ouvrez le boîtier pour accéder à l'intérieur du système, suivez les consignes suivantes:</p> <ol style="list-style-type: none">1. Mettez hors tension tous les périphériques connectés au système.2. Mettez le système hors tension en mettant l'interrupteur général en position OFF (bouton-poussoir).3. Débranchez tous les cordons d'alimentation c.a. du système et des prises murales.4. Identifiez et débranchez tous les câbles reliés aux connecteurs d'E-S ou aux accès derrière le système.5. Pour prévenir les décharges électrostatiques lorsque vous touchez aux composants, portez une bande antistatique pour poignet et reliez-la à la masse du système (toute surface métallique non peinte du boîtier).6. Ne faites pas fonctionner le système tandis que le boîtier est ouvert.
	<p>Une fois TOUTES les étapes précédentes accomplies, vous pouvez retirer les panneaux du système. Procédez comme suit:</p> <ol style="list-style-type: none">1. Si un cadenas a été installé sur à l'arrière du système, déverrouillez-le et retirez-le.2. Retirez toutes les vis des panneaux et mettez-les dans un endroit sûr.3. Retirez les panneaux.
	<p>Afin de permettre le refroidissement et l'aération du système, réinstallez toujours les panneaux du boîtier avant de mettre le système sous tension. Le fonctionnement du système en l'absence des panneaux risque d'endommager ses pièces. Pour installer les panneaux, procédez comme suit:</p> <ol style="list-style-type: none">1. Assurez-vous de ne pas avoir oublié d'outils ou de pièces démontées dans le système.2. Assurez-vous que les câbles, les cartes d'extension et les autres composants sont bien installés.3. Revissez solidement les panneaux du boîtier avec les vis retirées plus tôt.4. Remettez le cadenas en place et verrouillez-le afin de prévenir tout accès non autorisé à l'intérieur du système.5. Rebranchez tous les cordons d'alimentation c. a. et câbles externes au système.

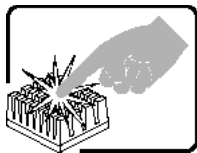

Le microprocesseur et le dissipateur de chaleur peuvent être chauds si le système a été sous tension. Faites également attention aux broches aiguës des cartes et aux bords tranchants du capot. Nous vous recommandons l'usage de gants de protection.

document avant de suivre toute instruction. Consultez Intel Server Boards and Server Chassis Safety Information sur le CD Resource CD ou bien rendez-vous sur le site <http://support.intel.com/support/motherboards/server/sb/cs-010770.htm>.

Español

Lea todas las declaraciones de seguridad y precaución de este documento antes de realizar cualquiera de las instrucciones. Vea Intel Server Boards and Server Chassis Safety Information en el CD Resource y/o en <http://support.intel.com/support/motherboards/server/sb/cs-010770.htm>



Nótese que el interruptor activado / desactivado en el panel frontal no desconecta la corriente alterna del sistema. Para desconectarla, deberá desenchufar todos los cables de corriente alterna de la pared o desconectar la fuente de alimentación.



INSTRUCCIONES DE SEGURIDAD: Cuando extraiga la tapa del chasis para acceder al interior del sistema, siga las siguientes instrucciones:

1. Apague todos los dispositivos periféricos conectados al sistema.
2. Apague el sistema presionando el interruptor encendido / apagado.
3. Desconecte todos los cables de alimentación CA del sistema o de las tomas de corriente alterna.
4. Identifique y desconecte todos los cables enchufados a los conectores E/S o a los puertos situados en la parte posterior del sistema.
5. Cuando manipule los componentes, es importante protegerse contra la descarga electrostática (ESD). Puede hacerlo si utiliza una muñequera antiestática sujeta a la toma de tierra del chasis - o a cualquier tipo de superficie de metal sin pintar.
6. No ponga en marcha el sistema si se han extraído las tapas del chasis.

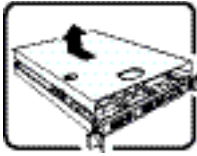
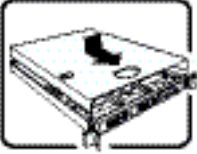
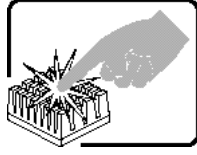
	<p>Después de completar las seis instrucciones de SEGURIDAD mencionadas, ya puede extraer las tapas del sistema. Para ello:</p> <ol style="list-style-type: none"> 1. Desbloquee y extraiga el bloqueo de seguridad de la parte posterior del sistema, si se ha instalado uno. 2. Extraiga y guarde todos los tornillos de las tapas. Extraiga las tapas.
	<p>Para obtener un enfriamiento y un flujo de aire adecuados, reinstale siempre las tapas del chasis antes de poner en marcha el sistema. Si pone en funcionamiento el sistema sin las tapas bien colocadas puede dañar los componentes del sistema. Para instalar las tapas:</p> <ol style="list-style-type: none"> 1. Asegúrese primero de no haber dejado herramientas o componentes sueltos dentro del sistema. 2. Compruebe que los cables, las placas adicionales y otros componentes se hayan instalado correctamente. 3. Incorpore las tapas al chasis mediante los tornillos extraídos anteriormente, tensándolos firmemente. 4. Inserte el bloqueo de seguridad en el sistema y bloquéelo para impedir que pueda accederse al mismo sin autorización. 5. Conecte todos los cables externos y los cables de alimentación CA al sistema.
	<p>Si el sistema ha estado en funcionamiento, el microprocesador y el disipador de calor pueden estar aún calientes. También conviene tener en cuenta que en el chasis o en el tablero puede haber piezas cortantes o punzantes. Por ello, se recomienda precaución y el uso de guantes protectores.</p>

Italiano

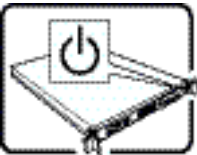
	<p>L'interruttore attivato / disattivato nel pannello anteriore non interrompe l'alimentazione in c.a. del sistema. Per interromperla, è necessario scollegare tutti i cavi di alimentazione in c.a. dalle prese a muro o dall'alimentazione di corrente.</p>
---	---

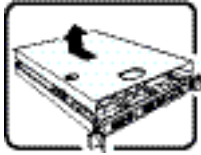
	<p>PASSI DI SICUREZZA: Qualora si rimuovano le coperture del telaio per accedere all'interno del sistema, seguire i seguenti passi:</p> <ol style="list-style-type: none"> 1. Spegner tutti i dispositivi periferici collegati al sistema. 2. Spegner il sistema, usando il pulsante spento / acceso dell'interruttore del sistema. 3. Togliere tutte le spine dei cavi del sistema dalle prese elettriche. 4. Identificare e sconnettere tutti i cavi attaccati ai collegamenti I/O od alle prese installate sul retro del sistema. 5. Qualora si tocchino i componenti, proteggersi dallo scarico elettrostatico (SES), portando un cinghia anti-statica da polso che è attaccata alla presa a terra del telaio del sistema - qualsiasi superficie non dipinta - . 6. Non far operare il sistema quando il telaio è senza le coperture.
	<p>Dopo aver seguito i sei passi di SICUREZZA sopracitati, togliere le coperture del telaio del sistema come segue:</p> <ol style="list-style-type: none"> 1. Aprire e rimuovere il lucchetto dal retro del sistema qualora ve ne fosse uno installato. 2. Togliere e mettere in un posto sicuro tutte le viti delle coperture. 3. Togliere le coperture.
	<p>Per il giusto flusso dell'aria e raffreddamento del sistema, rimettere sempre le coperture del telaio prima di riaccendere il sistema. Operare il sistema senza le coperture al loro proprio posto potrebbe danneggiare i componenti del sistema. Per rimettere le coperture del telaio:</p> <ol style="list-style-type: none"> 1. Controllare prima che non si siano lasciati degli attrezzi o dei componenti dentro il sistema. 2. Controllare che i cavi, dei supporti aggiuntivi ed altri componenti siano stati installati appropriatamente. 3. Attaccare le coperture al telaio con le viti tolte in precedenza e avvitarle strettamente. 4. Inserire e chiudere a chiave il lucchetto sul retro del sistema per impedire l'accesso non autorizzato al sistema. 5. Ricollegare tutti i cavi esterni e le prolunghe AC del sistema.
	<p>Se il sistema è stato a lungo in funzione, il microprocessore e il dissipatore di calore potrebbero essere surriscaldati. Fare attenzione alla presenza di piedini appuntiti e parti taglienti sulle schede e sul telaio. È consigliabile l'uso di guanti di protezione.</p>

Appendix C: Regulatory and Certification Information

This RAID Controller Card complies with the following safety and electromagnetic compatibility (EMC) regulations.

Product Safety Compliance

- UL 1950 - CSA 950 (US/Canada)
- EN 60 950 (European Union)
- IEC60 950 (International)
- CE - Low Voltage Directive (73/23/EEC) (European Union)

Product EMC Compliance - Class B





- FCC / ICES-003 (USA/Canada)
- CISPR 22 (International)
- EN55022 (Europe)
- EN55024 (Europe)
- CE - EMC Directive 89/336/EEC (Europe)
- VCCI (Japan)
- AS/NZS 3548 (Australia / New Zealand)
- BSMI CNS13438 (Taiwan)
- RRL, MIC Notice No. 1997-41 (EMC) & 1997-42 (EMI) (Korea)



Product Regulatory Compliance Markings

The RAID Controller Card is marked with the following compliance markings. Some marking information may be provided on the packaging and/or in the product documentation due to limited marking space on the product.

- ETL NRTL Mark (US/Canada)
- FCC Mark (US)
- ICES-003 (Canada)
- CE Mark (Europe)
- VCCI Mark (Japan)
- MIC Mark (Korea)

- BSMI DOC Mark (Taiwan)
- ACS C-Tick Mark (Australia)

Regulatory Compliance	Country	Marking
UL Listing Marks	USA/Canada	
ETL (NRTL) Mark	USA/Canada	
CE Mark	Europe	
FCC Marking (Class A)	USA	This device complies with Part 15 of the FCC Rules. Operation of this device is subject to the following two conditions: (1) This device may not cause harmful interference, and (2) This device must accept any interference received, including interference that may cause undesired operation.
FCC Marking (Class B)	USA	 Tested to Comply With FCC standards FOR HOME OR OFFICE USE
EMC Marking (Class A)	Canada	CANADA ICES-003 CLASS A CANADA NMB-003 CLASSE A
EMC Marking (Class B)	Canada	CANADA ICES-003 CLASS B CANADA NMB-003 CLASSE B
VCCI Marking (Class A)	Japan	この装置は、情報処理装置等電波障害自主規制協議会（VCCI）の基準に基づきクラスA情報技術装置です。この装置を家庭環境で使用すると電波妨害を引き起こすことがあります。この場合には使用者が適切な対策を講ずるよう要求されることがあります。
VCCI Marking (Class B)	Japan	この装置は、情報処理装置等電波障害自主規制協議会（VCCI）の基準に基づきクラスB情報技術装置です。この装置は、家庭環境で使用することを目的としていますが、この装置がラジオやテレビジョン受信機に近接して使用されると、受信障害を引き起こすことがあります。 取扱説明書に従って正しい取り扱いをして下さい。 

Regulatory Compliance	Country	Marking
BSMI Marking (Class A or B) and Class A EMC Warning	Taiwan	 <p>警告使用者： 這是甲類的資訊產品，在居住的環境中使用時，可能會造成射頻干擾，在這種情況下，使用者會被要求採取某些適當的對策</p>
RRL MIC Mark	Korea	
C-Tick Mark	Australia	

Electromagnetic Compatibility Notices

FCC Verification Statement (USA) :

This device complies with Part 15 of the FCC Rules. Operation is subject to the following two conditions: (1) This device may not cause harmful interference, and (2) this device must accept any interference received, including interference that may cause undesired operation.

Intel Corporation
5200 N.E. Elam Young Parkway
Hillsboro, OR 97124-6497
Phone: 1-800-628-8686

This equipment has been tested and found to comply with the limits for a Class B digital device, pursuant to Part 15 of the FCC Rules. These limits are designed to provide reasonable protection against harmful interference in a residential installation. This equipment generates, uses, and can radiate radio frequency energy and, if not installed and used in accordance with the instructions, may cause harmful interference to radio communications. However, there is no guarantee that interference will not occur in a particular installation. If this equipment does cause harmful interference to radio or television reception, which can be determined by turning the equipment off and on, the user is encouraged to try to correct the interference by one or more of the following measures:

- Reorient or relocate the receiving antenna.
- Increase the separation between the equipment and the receiver.

- Connect the equipment into an outlet on a circuit different from that to which the receiver is connected.
- Consult the dealer or an experienced radio/TV technician for help.

Intel is not responsible for any radio or television interference caused by unauthorized modification of this equipment for substitution or attachment of connecting cables and equipment other than those specified by Intel. The correction of interferences caused by such unauthorized modification, substitution, or attachment will be the responsibility of the user.

This RAID Controller has been tested to comply with FCC standards for home or office use.

- ICES-003 (Canada) This digital apparatus does not exceed the Class B limits for radio noise emissions from digital apparatus set out in the interference-causing equipment standard entitled "Digital Apparatus," ICES-003 of the Canadian Department of Communications.
Cet appareil numérique respecte les limites bruits radioélectriques applicables aux appareils numériques de Classe A prescrites dans la norme sur le matériel brouilleur: "Appareils Numériques", NMB-003 édictée par le Ministre Canadien des Communications.
- Europe (CE Declaration of Conformity) This product has been tested in accordance too, and complies with the Low Voltage Directive (73/23/EEC) and EMC Directive (89/336/EEC). The product has been marked with the CE Mark to illustrate its compliance.
- RRL (Korea): Type of Equipment (Model Name): Model name on product
 - Certification No.: On RRL certificate. Obtain certificate from local Intel representative
 - Name of Certification Recipient: LSI Logic Corporation
 - Date of Manufacturer: Refer to date code on product
 - Manufacturer: LSI Logic Corporation Manufacturer/Nation / Refer to country of origin marked on product