

Intel[®] NUC Kit NUC7i5BNK Intel[®] NUC Kit NUC7i3BNK User Guide

Before You Begin



CAUTIONS

The procedures in this user guide assume familiarity with the general terminology associated with personal computers and with the safety practices and regulatory compliance required for using and modifying electronic equipment.

Disconnect the computer from its power source and from any telecommunications link or network before performing any of the procedures described in this guide. Failure to disconnect power, telecommunications links, or networks before you open the computer or perform any procedures can result in personal injury or equipment damage. Some circuitry on the board can continue to operate even though the front panel power button is off.

Follow these guidelines before you begin:

- Always follow the steps in each procedure in the correct order.
- Set up a log to record information about your computer, such as model, serial numbers, installed options, and configuration information.
- Electrostatic discharge (ESD) can damage components. Perform the procedures described in this chapter only at an ESD workstation using an antistatic wrist strap and a conductive foam pad. If such a station is not available, you can provide some ESD protection by wearing an antistatic wrist strap and attaching it to a metal part of the computer chassis.

Installation Precautions

When you install and test the Intel NUC, observe all warnings and cautions in the installation instructions.

To avoid injury, be careful of:

- Sharp pins on connectors
- Sharp pins on circuit boards
- Rough edges and sharp corners on the chassis
- Hot components (such as SSDs, processors, voltage regulators, and heat sinks)
- Damage to wires that could cause a short circuit

Observe all warnings and cautions that instruct you to refer computer servicing to qualified technical personnel.

Observe Safety and Regulatory Requirements

If you do not follow these instructions, you increase your safety risk and the possibility of noncompliance with regional laws and regulations.

This guide tells you how to:

- Install an M.2 SSD
- Install and remove memory
- Install a VESA mount bracket
- Connect power
- Install an operating system
- Install the latest device drivers and software

Open the Intel NUC Chassis

To open the Intel NUC chassis, follow these steps:

1. Unscrew the four corner screws on the bottom cover of the chassis and lift the cover.

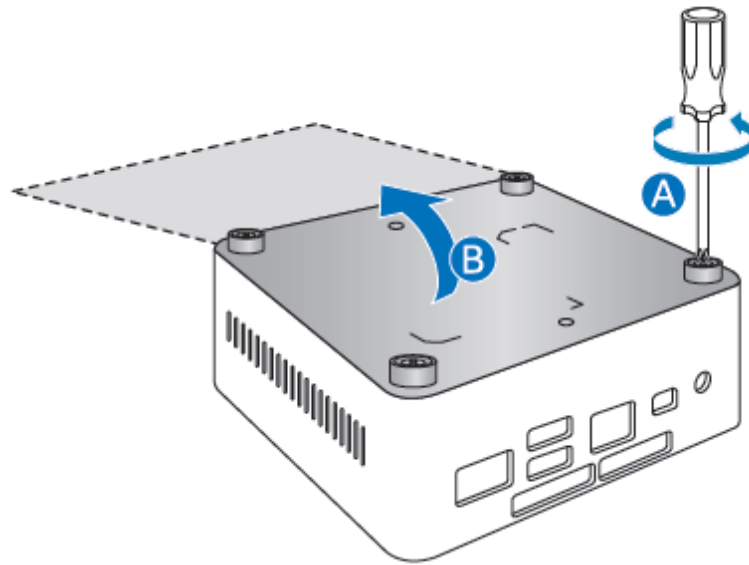

Install an M.2 SSD

Intel NUC Kits NUC7i3BNK and NUC7i5BNK support 80mm, 60mm, and 42mm M.2 SSDs. For a list of tested M.2 SSDs, go to the Intel® Product Compatibility Tool:

- [NUC7i5BNK](#)
- [NUC7i3BNK](#)

Observe the precautions in "Before You Begin" on page 2.

If you are installing an 80mm M.2 SSD:

1. Remove the small silver screw from the 80mm metal standoff on the motherboard (A).
2. Remove the standoff from the 42mm position (B).
3. Align the small notch at the bottom edge of the M.2 card with the key in the connector.

4. Insert the bottom edge of the M.2 card into the connector (C).
5. Secure the card to the standoff with the small silver screw (D).

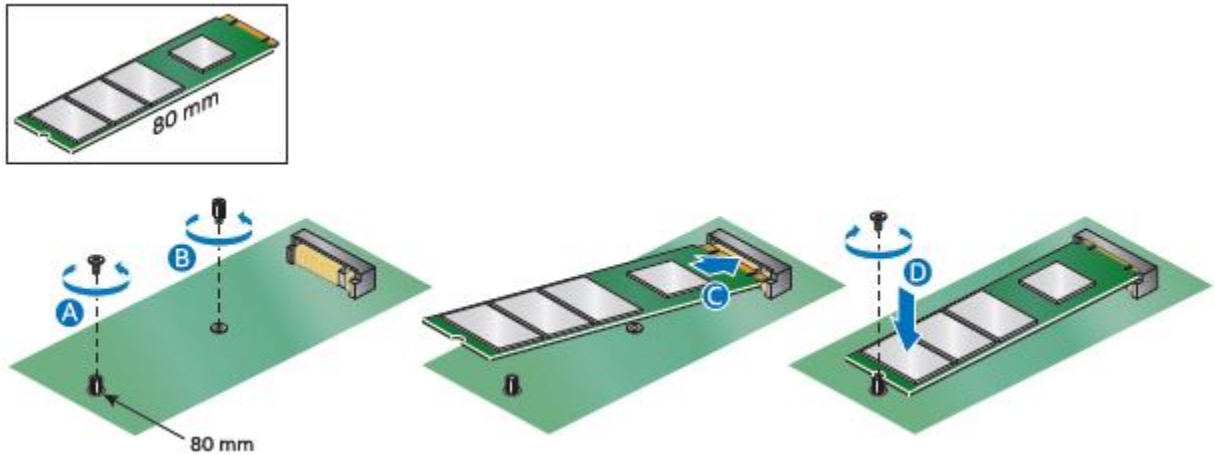

If you are installing a 42mm M.2 SSD:

1. Remove the small silver screw from the metal standoff on the motherboard (A).
2. Align the small notch at the bottom edge of the M.2 card with the key in the connector.
3. Insert the bottom edge of the M.2 card into the connector (B).
4. Secure the card to the standoff with the small silver screw (C).

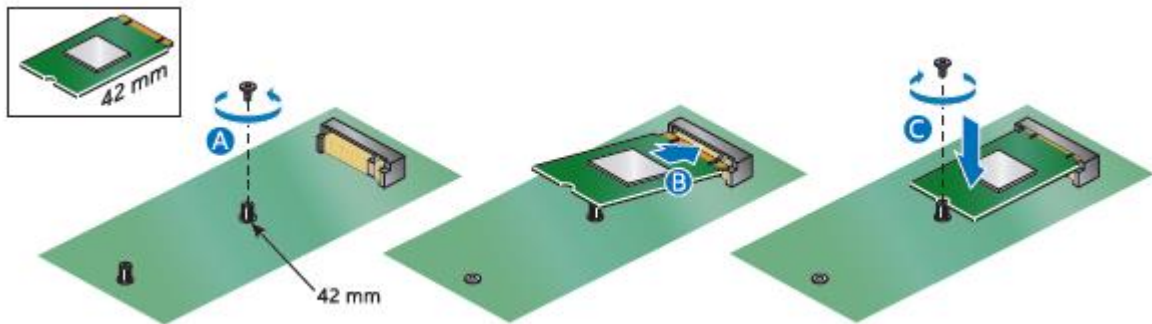

Installing and Removing Memory

Intel NUC Kits NUC7i3BNK and NUC7i5BNK have two DDR4 SO-DIMM sockets. Memory requirements:

- 1.2V memory
- 1866 MHz or 2133 MHz SO-DIMMs
- Non-ECC

For a list of tested memory, go to the Intel® Product Compatibility Tool:

- [NUC7i5BNK](#)
- [NUC7i3BNK](#)

Install SO-DIMMs

If you plan to install just one SO-DIMM, install it in the lower memory socket.

To install the SO-DIMMs, follow these steps:

1. Observe the precautions in "Before You Begin" on page 2.
2. Turn off all peripheral devices connected to the computer. Turn off the computer and disconnect the AC power cord.

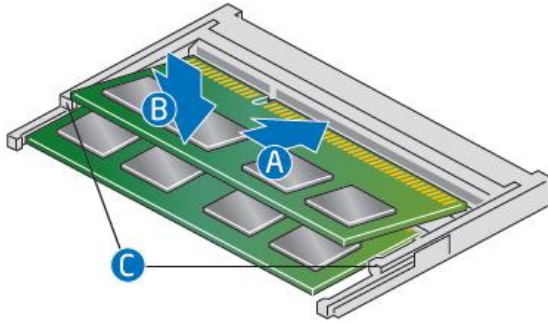

3. Align the small notch at the bottom edge of the SO-DIMM with the key in the socket.
4. Insert the bottom edge of the SO-DIMM into the socket.
5. When the SO-DIMM is inserted, push down on the outer edge of the SO-DIMM until the retaining clips snap into place. Make sure the clips are firmly in place.

Removing SO-DIMMs

To remove a SO-DIMM, follow these steps:

1. Observe the precautions in "Before You Begin" on page 2.
2. Turn off all peripheral devices connected to the computer. Turn off the computer.
3. Remove the AC power cord from the computer.
4. Remove the computer's cover.
5. Gently spread the retaining clips at each end of the SO-DIMM socket. The SO-DIMM pops out of the socket.
6. Hold the SO-DIMM by the edges, lift it away from the socket, and store it in an anti-static package.
7. Reinstall and reconnect any parts you removed or disconnected to reach the SO-DIMM sockets.
8. Replace the computer's cover and reconnect the AC power cord.

Close the Chassis

After all components have been installed, close the Intel NUC chassis.



Attach and Use the VESA Bracket (Optional)

Follow these instructions to attach and use the VESA mount bracket:

1. Attach the VESA bracket to the back of the monitor or TV, using the four small black screws that were included in the box.

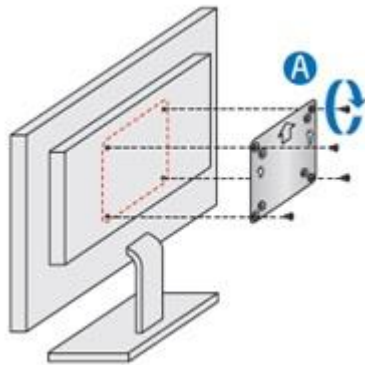

2. Attach the two slightly larger black screws to the bottom chassis cover of the Intel NUC.

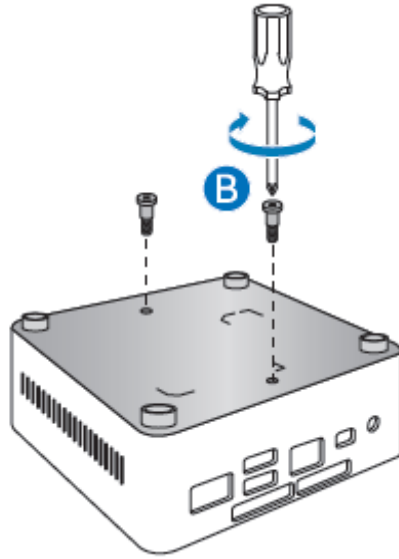

3. Slide the Intel NUC onto the VESA mount bracket.

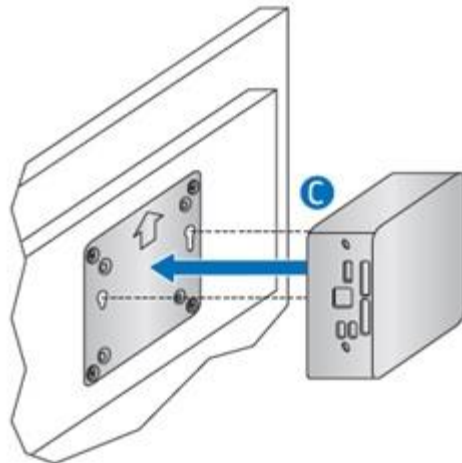

Connect Power

Country-specific power plug attachments are included in the Intel NUC Kit box.

1. Choose the attachment for your region.

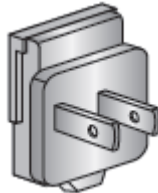
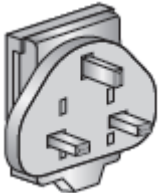
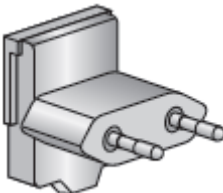
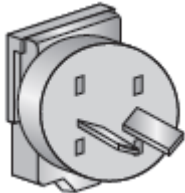
SKU (Product codes)	Attachments in the box			
NUC7i5BNK NUC7i3BNK				
	US – United States	UK – United Kingdom	EU – European Union	AUS - Australia

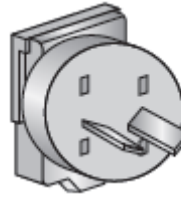
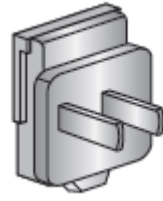
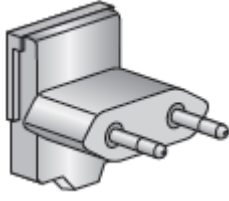
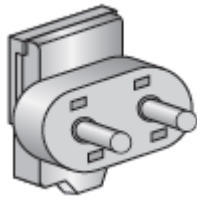
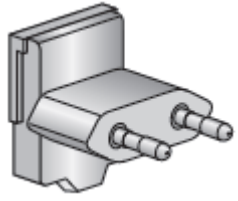
NUC7i5BNKL NUC7i3BNKL					
	ARG - Argentina	CHN - China	BRA - Brazil	IND - India	KOR – South Korea

2. Slide the attachment (B) onto the power plug, locking it into place (A).

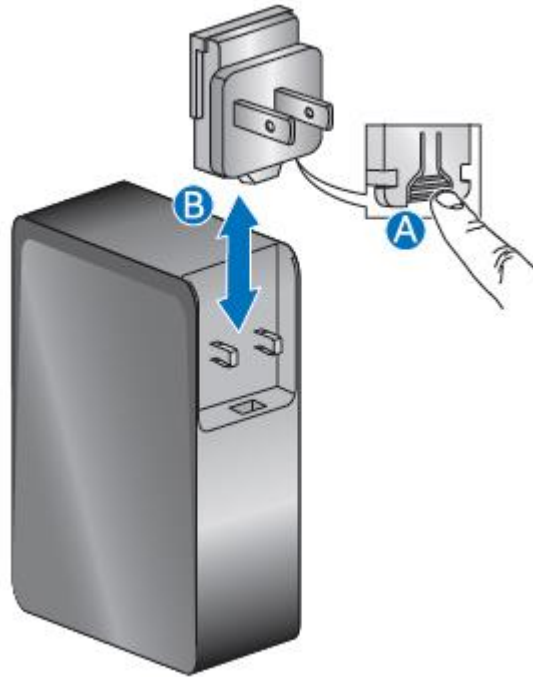

3. Connect AC power.

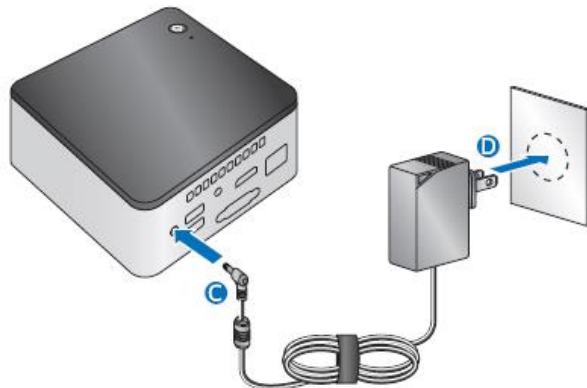

Install an Operating System

Refer to [Supported Operating Systems](#) for a list of Intel-validated Windows* operating systems, as well as versions of Linux that have been reported as compatible by Intel NUC owners.

Refer to [Operating System Installation](#) for system requirements and installation steps.

Install the Latest Device Drivers and Software

Here are the options for keeping device drivers current:

- Allow the [Intel® Driver & Support Assistant \(Intel® DSA\)](#) to detect out-of-date drivers
- Manually download drivers, BIOS, and software from Download Center:
 - [NUC7i3BNK](#)
 - [NUC7i5BNK](#)

The following device drivers and software are available.

- Intel® Chipset Device Software
- Intel® HD Graphics
- Intel® Management Engine
- Intel® Wireless
- Intel® Bluetooth
- Intel® Gigabit Ethernet
- Thunderbolt™ Bus (NUC7i5BNH and NUC7i7BNH only)
- Realtek* High Definition Audio
- Realtek* Card Reader
- ITE Tech* Consumer Infrared
- Intel® Rapid Storage Technology
- Intel® Software Guard Extensions
- Thunderbolt™ 3 Controller Firmware
- HDMI Firmware