

# Intel® NUC Kit DC53427HYE User Guide

---

## Before You Begin



### CAUTIONS

*The procedures in this user guide assume familiarity with the general terminology associated with personal computers and with the safety practices and regulatory compliance required for using and modifying electronic equipment.*

*Disconnect the computer from its power source and from any telecommunications link or network before performing any of the procedures described in this guide. Failure to disconnect power, telecommunications links, or networks before you open the computer or perform any procedures can result in personal injury or equipment damage. Some circuitry on the board can continue to operate even though the front panel power button is off.*

Follow these guidelines before you begin:

- Always follow the steps in each procedure in the correct order.
- Set up a log to record information about your computer, such as model, serial numbers, installed options, and configuration information.
- Electrostatic discharge (ESD) can damage components. Perform the procedures described in this chapter only at an ESD workstation using an antistatic wrist strap and a conductive foam pad. If such a station is not available, you can provide some ESD protection by wearing an antistatic wrist strap and attaching it to a metal part of the computer chassis.

## Installation Precautions

When you install and test the Intel NUC, observe all warnings and cautions in the installation instructions.

To avoid injury, be careful of:

- Sharp pins on connectors
- Sharp pins on circuit boards
- Rough edges and sharp corners on the chassis
- Hot components (such as SSDs, processors, voltage regulators, and heat sinks)
- Damage to wires that could cause a short circuit

Observe all warnings and cautions that instruct you to refer computer servicing to qualified technical personnel.

## Observe Safety and Regulatory Requirements

If you do not follow these instructions, you increase your safety risk and the possibility of noncompliance with regional laws and regulations.

## This guide tells you how to:

- Install and remove memory
- Install a wireless card
- Install an mSATA SSD
- Install a VESA mount bracket
- Install an operating system
- Install the latest drivers

## Open the Intel NUC Chassis

To open the Intel NUC chassis, follow these steps:

1. Unscrew the four corner screws on the bottom cover of the chassis and lift the cover.

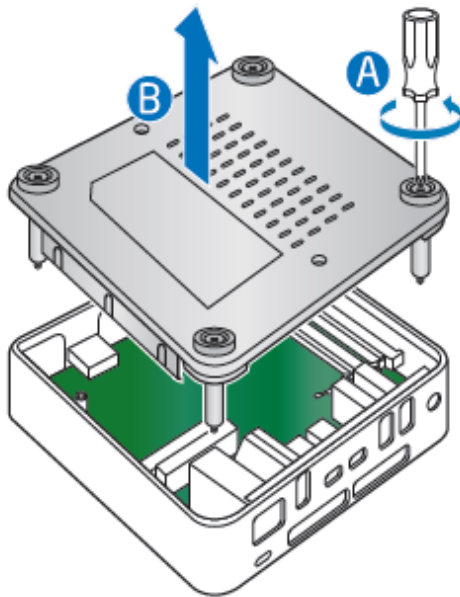

## Installing and Removing Memory

Intel NUC Kit DC53427HYE has two 204-pin SO-DIMM sockets. Memory requirements:

- 1.5V DDR3 or 1.35V DDR3L (low voltage) memory
- 1333 MHz or 1600 MHz SO-DIMMs
- Non-ECC

For a list of tested memory, go to the [System Memory](#) page on the Support site:

## Install SO-DIMMs

If you plan to install just one SO-DIMM, install it in the lower memory socket.

To install the SO-DIMMs, follow these steps:

1. Observe the precautions in "Before You Begin" on page 2.

2. Turn off all peripheral devices connected to the computer. Turn off the computer and disconnect the AC power cord.

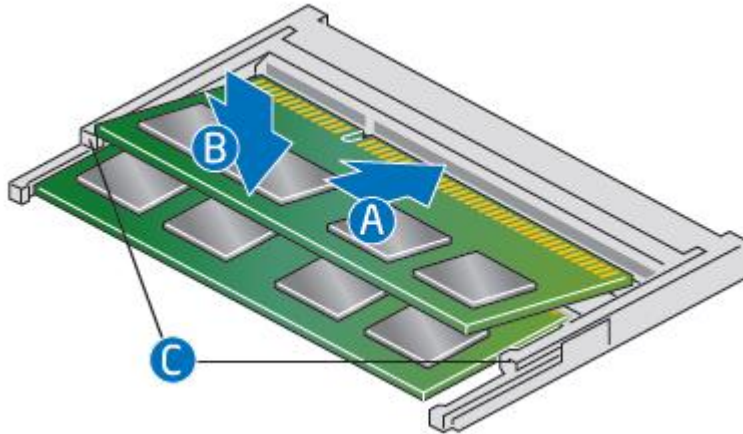

3. Align the small notch at the bottom edge of the SO-DIMM with the key in the socket.
4. Insert the bottom edge of the SO-DIMM into the socket.
5. When the SO-DIMM is inserted, push down on the outer edge of the SO-DIMM until the retaining clips snap into place. Make sure the clips are firmly in place.

## Removing SO-DIMMs

To remove a SO-DIMM, follow these steps:

1. Observe the precautions in "Before You Begin" on page 2.
2. Turn off all peripheral devices connected to the computer. Turn off the computer.
3. Remove the AC power cord from the computer.
4. Remove the computer's cover.
5. Gently spread the retaining clips at each end of the SO-DIMM socket. The SO-DIMM pops out of the socket.
6. Hold the SO-DIMM by the edges, lift it away from the socket, and store it in an anti-static package.
7. Reinstall and reconnect any parts you removed or disconnected to reach the SO-DIMM sockets.
8. Replace the computer's cover and reconnect the AC power cord.

## Installing a Mini-PCIe Wireless Adapter

Only the following wireless adapters have been evaluated for regulatory compliance for use with the Intel NUC Kit DC53427HYE in all regions:

- Intel® Centrino® Advanced-N 6235
- Intel® Centrino® Advanced-N 6205
- Intel® Centrino® Wireless-N 2230
- Intel® Centrino® Wireless-N 2200
- Intel® Dual Band Wireless-AC 7260 + Bluetooth\*
- Intel® Dual Band Wireless-N 7260 + Bluetooth
- Intel® Dual Band Wireless-N 7260
- Intel® Wireless-N 7260 + Bluetooth

The operation of any other wireless adapter with Intel® NUC Kit DC53427HYE, other than those listed above, may violate regulatory compliance requirements for your region.

For more information on wireless adapters, go to: <http://www.intel.com/support/wireless/wlan>.



**CAUTION**

*When installing a Mini-PCIe wireless adapter on the Intel NUC, ensure that the adapter is fully seated in the connector before you power on the system. If the adapter is not fully seated in the connector, an electrical short may result across the connector pins. Depending on the over-current protection of the power supply, certain Intel NUC components and/or traces may be damaged.*

## Install a Mini-PCIe Wireless Adapter

Follow these instructions to install a Mini-PCIe wireless adapter:

1. Observe the precautions in "Before You Begin" on page 2.
2. Remove the small silver screw from the metal standoff on the motherboard (A).

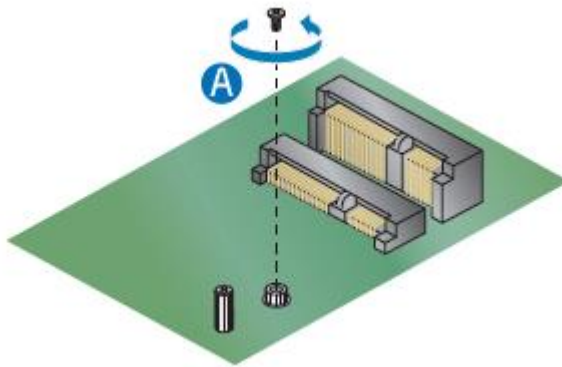

3. Align the small notch at the bottom edge of the wireless card with the key in the connector.
4. Insert the bottom edge of the wireless card into the connector (B).

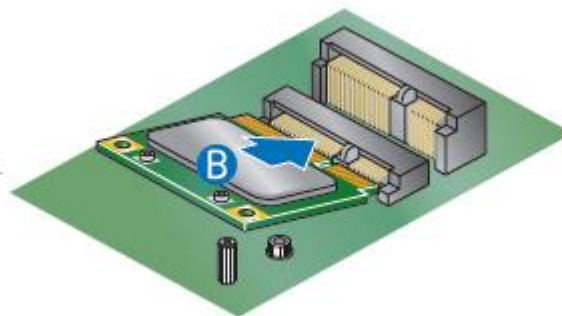

5. Secure the wireless card to the standoff with the small silver screw (C).

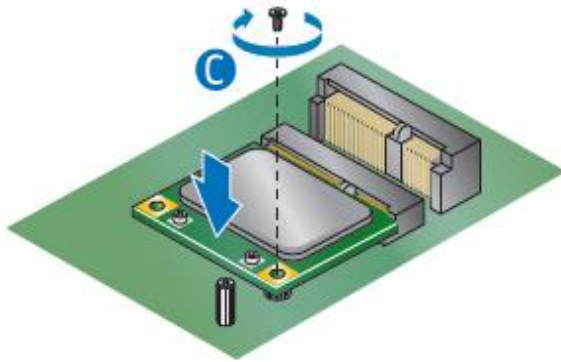

6. Remove the black tape holding the two wireless antennas.
7. Slide the clear plastic protective sleeve down onto the antenna wires, away from the connectors at the ends of the antennas (D).

**⚠ CAUTION** Do not attempt to pull the plastic protectors off the ends of the antennas. Doing so is likely to damage the metal leads of the antennas.

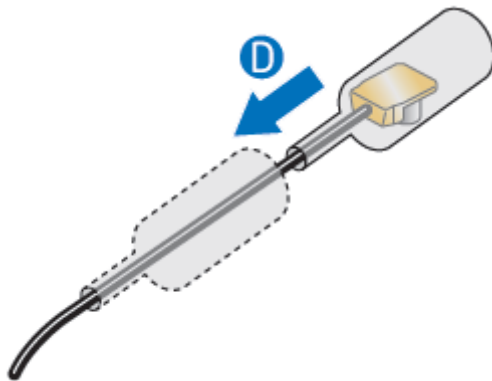

8. Attach the antenna leads to the connectors on the wireless card (E).

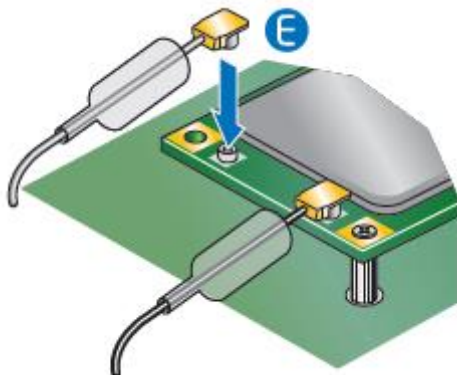

## Install an mSATA SSD

For a list of tested mSATA drives, go to the [Tested Peripherals](#) page on the Support site.

Follow these instructions to install an mSATA SSD:

1. Observe the precautions in "Before You Begin" on page 2.
2. Remove the small silver screw from the metal standoff on the motherboard (A).

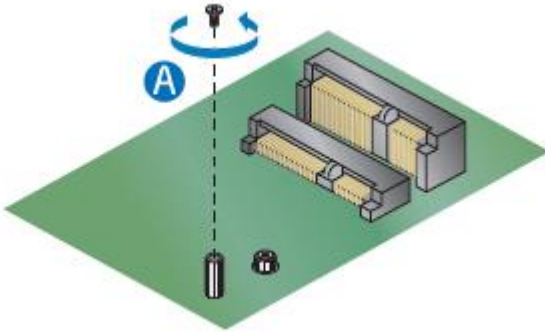

3. Align the small notch at the bottom edge of the mSATA card with the key in the connector.
4. Insert the bottom edge of the mSATA card into the connector (B).

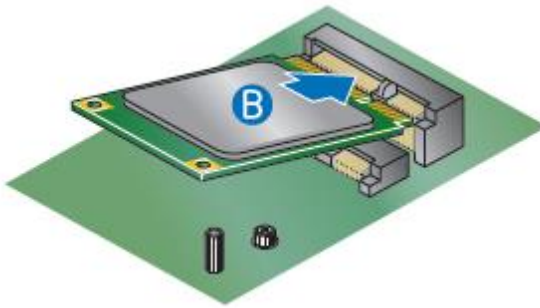

5. Secure the card to the standoff with the small silver screw (C).

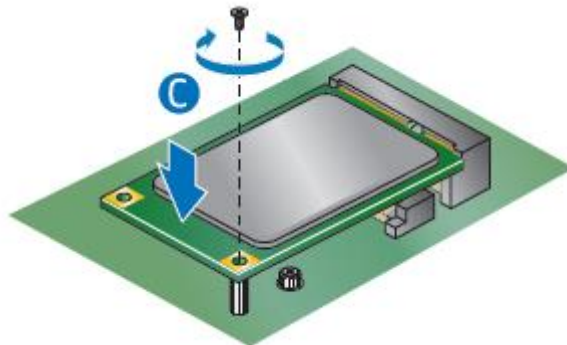

## Close the Chassis

After all components have been installed, close the Intel NUC chassis. Intel recommends this be done by hand with a screwdriver to avoid over-tightening and possibly damaging the screws.

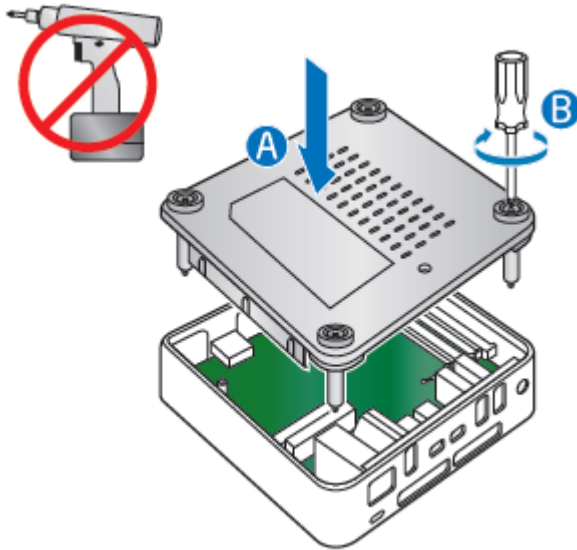

## Attach and Use the VESA Bracket (Optional)

Follow these instructions to attach and use the VESA mount bracket:

1. Using the four small black screws that were included in the box, attach the VESA bracket to the back of the monitor or TV.

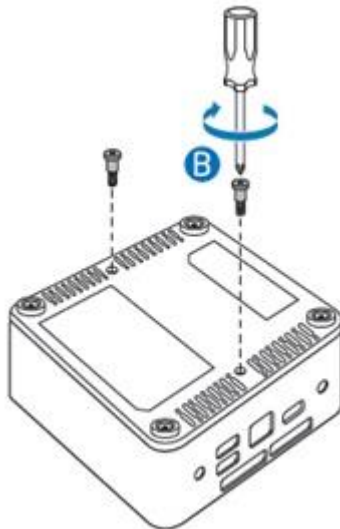



2. Attach the two slightly larger black screws to the bottom chassis cover of the Intel NUC.

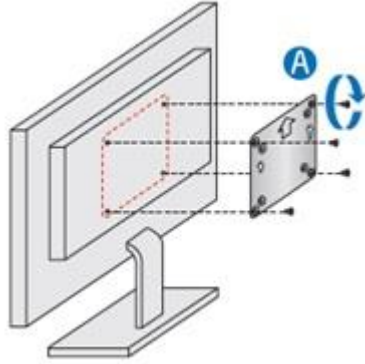

3. Slide the Intel NUC onto the VESA mount bracket.

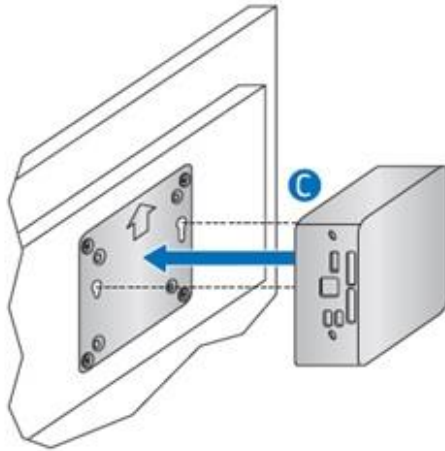

## Install an Operating System

Refer to [Supported Operating Systems](#) for a list of Intel-validated Windows\* operating systems, as well as versions of Linux that have been reported as compatible by Intel NUC owners.

Refer to [Operating System Installation](#) for system requirements and installation steps.

## Install Intel NUC Drivers

To download the latest Microsoft\* Windows\* drivers and BIOS updates, go to [Download Center](#):

Drivers are available for the following features:

- Chipset
- Graphics
- Intel® ME
- Intel® Rapid Start Technology
- Intel® Rapid Storage Technology
- Intel® Smart Connect Technology
- LAN
- USB 3.0