

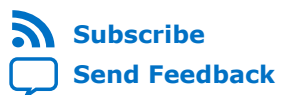

Avalon[®] Interface Specifications

Updated for Intel[®] Quartus[®] Prime Design Suite: **18.0**



[Subscribe](#)

[Send Feedback](#)

MNL-AVABUSREF | 2018.05.22

Latest document on the web: [PDF](#) | [HTML](#)



Contents

- 1. Introduction to the Avalon Interface Specifications..... 4**
 - 1.1. Avalon Properties and Parameters..... 7
 - 1.2. Signal Roles 7
 - 1.3. Interface Timing 7

- 2. Avalon Clock and Reset Interfaces 8**
 - 2.1. Avalon Clock Sink Signal Roles 8
 - 2.2. Clock Sink Properties 9
 - 2.3. Associated Clock Interfaces 9
 - 2.4. Avalon Clock Source Signal Roles 9
 - 2.5. Clock Source Properties..... 9
 - 2.6. Reset Sink 10
 - 2.7. Reset Sink Interface Properties..... 10
 - 2.8. Associated Reset Interfaces 10
 - 2.9. Reset Source 10
 - 2.10. Reset Source Interface Properties..... 11

- 3. Avalon Memory-Mapped Interfaces..... 12**
 - 3.1. Introduction to Avalon Memory-Mapped Interfaces 12
 - 3.2. Avalon Memory-Mapped Interface Signal Roles..... 14
 - 3.3. Interface Properties 18
 - 3.4. Timing 21
 - 3.5. Transfers 21
 - 3.5.1. Typical Read and Write Transfers 21
 - 3.5.2. Transfers Using the waitrequestAllowance Property..... 23
 - 3.5.3. Read and Write Transfers with Fixed Wait-States 26
 - 3.5.4. Pipelined Transfers 27
 - 3.5.5. Burst Transfers 30
 - 3.5.6. Read and Write Responses..... 33
 - 3.6. Address Alignment 35
 - 3.7. Avalon-MM Slave Addressing 35

- 4. Avalon Interrupt Interfaces 37**
 - 4.1. Interrupt Sender 37
 - 4.1.1. Avalon Interrupt Sender Signal Roles 37
 - 4.1.2. Interrupt Sender Properties 37
 - 4.2. Interrupt Receiver 38
 - 4.2.1. Avalon Interrupt Receiver Signal Roles 38
 - 4.2.2. Interrupt Receiver Properties 38
 - 4.2.3. Interrupt Timing 38

- 5. Avalon Streaming Interfaces 39**
 - 5.1. Terms and Concepts 40
 - 5.2. Avalon Streaming Interface Signal Roles 41
 - 5.3. Signal Sequencing and Timing 42
 - 5.3.1. Synchronous Interface 42
 - 5.3.2. Clock Enables 42
 - 5.4. Avalon-ST Interface Properties 42



- 5.5. Typical Data Transfers43
- 5.6. Signal Details 43
- 5.7. Data Layout 44
- 5.8. Data Transfer without Backpressure45
- 5.9. Data Transfer with Backpressure 45
 - 5.9.1. Data Transfers Using readyLatency and readyAllowance..... 46
 - 5.9.2. Data Transfers Using readyLatency.....48
- 5.10. Packet Data Transfers 49
- 5.11. Signal Details 50
- 5.12. Protocol Details51
- 6. Avalon Conduit Interfaces52**
 - 6.1. Avalon Conduit Signal Roles 53
 - 6.2. Conduit Properties 53
- 7. Avalon Tristate Conduit Interface 54**
 - 7.1. Avalon Tristate Conduit Signal Roles 56
 - 7.2. Tristate Conduit Properties 57
 - 7.3. Tristate Conduit Timing 57
- A. Deprecated Signals..... 59**
- B. Document Revision History for the Avalon Interface Specifications..... 60**



1. Introduction to the Avalon Interface Specifications

Avalon® interfaces simplify system design by allowing you to easily connect components in an Intel FPGA. The Avalon interface family defines interfaces appropriate for streaming high-speed data, reading and writing registers and memory, and controlling off-chip devices. These standard interfaces are designed into the components available in Platform Designer. You can also use these standardized interfaces in your custom components. By using these standard interfaces, you enhance the interoperability of your designs.

This specification defines all of the Avalon interfaces. After reading this specification, you should understand which interfaces are appropriate for your components and which signal roles to use for particular behaviors. This specification defines the following seven interfaces:

- Avalon Streaming Interface (Avalon-ST)—an interface that supports the unidirectional flow of data, including multiplexed streams, packets, and DSP data.
- Avalon Memory Mapped Interface (Avalon-MM)—an address-based read/write interface typical of master–slave connections.
- Avalon Conduit Interface— an interface type that accommodates individual signals or groups of signals that do not fit into any of the other Avalon types. You can connect conduit interfaces inside a Platform Designer system. Or, you can export them to make connections to other modules in the design or to FPGA pins.
- Avalon Tri-State Conduit Interface (Avalon-TC) —an interface to support connections to off-chip peripherals. Multiple peripherals can share pins through signal multiplexing, reducing the pin count of the FPGA and the number of traces on the PCB.
- Avalon Interrupt Interface—an interface that allows components to signal events to other components.
- Avalon Clock Interface—an interface that drives or receives clocks.
- Avalon Reset Interface—an interface that provides reset connectivity.

A single component can include any number of these interfaces and can also include multiple instances of the same interface type. For example, in the first figure below, the Ethernet Controller includes the following six different interface types:

- Avalon-MM
- Avalon-ST
- Avalon Conduit
- Avalon-TC
- Avalon Interrupt
- Avalon Clock.



Note: Avalon interfaces are an open standard. No license or royalty is required to develop and sell products that use, or are based on Avalon interfaces.

The following figures illustrate the use of the Avalon interfaces in system designs.

Figure 1. Avalon Interfaces in a System Design with Scatter Gather DMA Controller and Nios II Processor

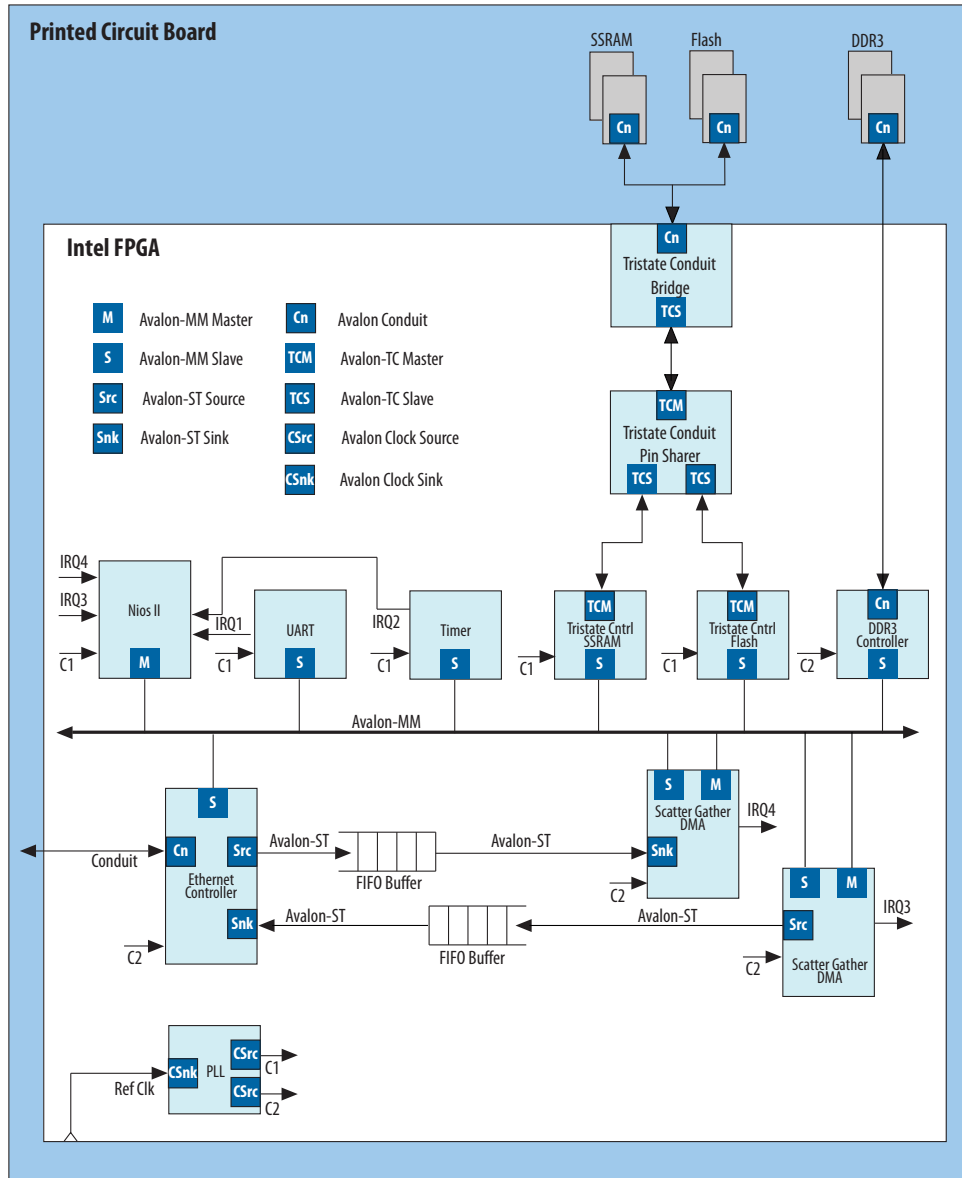

In this figure, the Nios® II processor accesses the control and status registers of on-chip components using an Avalon-MM interface. The scatter gather DMAs send and receive data using Avalon-ST interfaces. Four components include interrupt interfaces serviced by software running on the Nios II processor. A PLL accepts a clock via an

Avalon Clock Sink interface and provides two clock sources. Two components include Avalon-TC interfaces to access off-chip memories. Finally, the DDR3 controller accesses external DDR3 memory using an Avalon Conduit interface.

Figure 2. Avalon Interfaces in a System Design with PCI Express Endpoint and External Processor

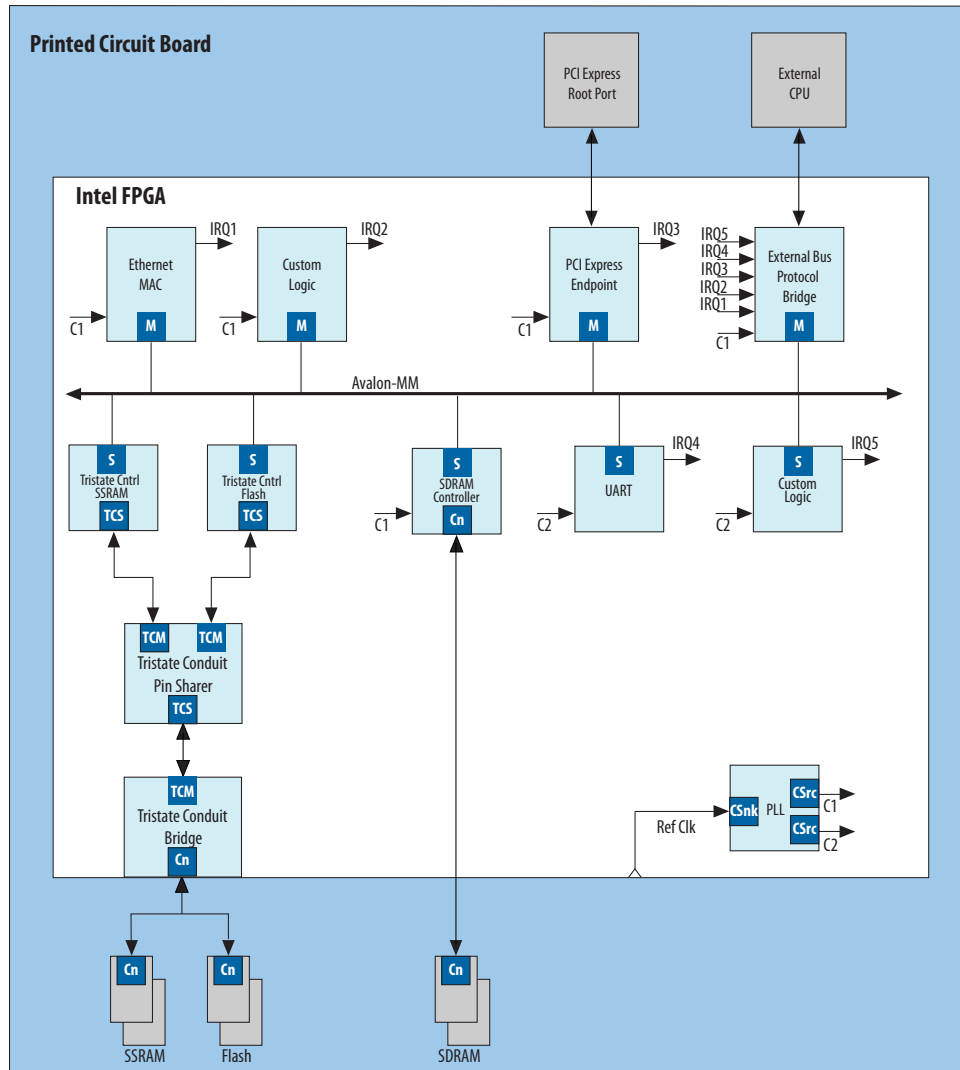

In the previous figure, an external processor accesses the control and status registers of on-chip components via an external bus bridge with an Avalon-MM interface. The PCI Express Root Port controls devices on the printed circuit board and the other components of the FPGA by driving an on-chip PCI Express Endpoint with an Avalon-MM master interface. An external processor handles interrupts from five components. A PLL accepts a reference clock via a Avalon Clock sink interface and provides two clock sources. The flash and SRAM memories use an Avalon-TC interface to share FPGA pins. Finally, an SDRAM controller accesses an external SDRAM memory using an Avalon Conduit interface.



Related Information

- [Introduction to Intel FPGA IP Cores](#)
Provides general information about all Intel FPGA IP cores, including parameterizing, generating, upgrading, and simulating IP cores.
- [Generating a Combined Simulator Setup Script](#)
Create simulation scripts that do not require manual updates for software or IP version upgrades.
- [Project Management Best Practices](#)
Guidelines for efficient management and portability of your project and IP files.

1.1. Avalon Properties and Parameters

Avalon interfaces use properties to describe their behavior. For example, the `maxChannel` property of Avalon-ST interfaces allows you to specify the number of channels supported by the interface. The `clockRate` property of the Avalon Clock interface provides the frequency of a clock signal. The specification for each interface type defines all of its properties and specifies the default values.

1.2. Signal Roles

Each of the Avalon interfaces defines a number of signal roles and their behavior. Many signal roles are optional. You have the flexibility to select only the signal roles necessary to implement the required functionality. For example, the Avalon-MM interface includes optional `beginbursttransfer` and `burstcount` signal roles for use in components that support bursting. The Avalon-ST interface includes the optional `startofpacket` and `endofpacket` signal roles for interfaces that support packets.

With the exception of Avalon Conduit interfaces, each interface may include only one signal of each signal role. Active-low signals are permitted for many signal roles. Active-high signals are generally used in this document.

1.3. Interface Timing

Subsequent chapters of this document include timing information that describes transfers for individual interface types. There is no guaranteed performance for any of these interfaces. Actual performance depends on many factors, including component design and system implementation.

Most Avalon interfaces must not be edge sensitive to signals other than the clock and reset. Other signals may transition multiple times before they stabilize. The exact timing of signals between clock edges varies depending upon the characteristics of the selected Intel FPGA. This specification does not specify electrical characteristics. Refer to the appropriate device documentation for electrical specifications.



2. Avalon Clock and Reset Interfaces

Avalon Clock interfaces define the clock or clocks used by a component. Components can have clock inputs, clock outputs, or both. A phase locked loop (PLL) is an example of a component that has both a clock input and clock outputs.

The following figure is a simplified illustration showing the most important inputs and outputs of a PLL component.

Figure 3. PLL Core Clock Outputs and Inputs

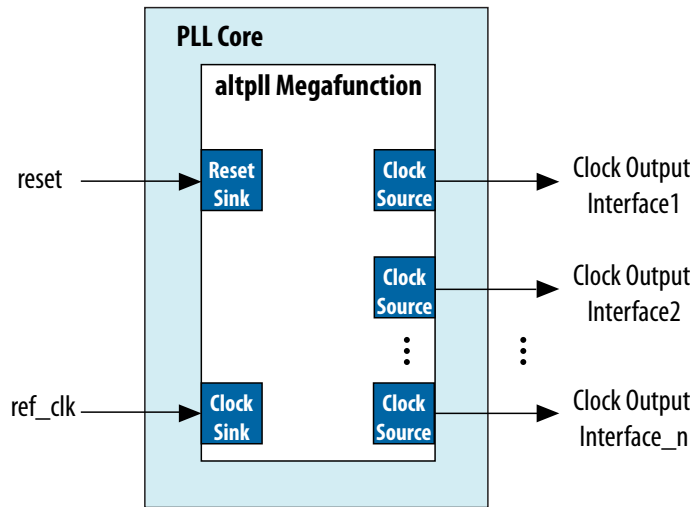

2.1. Avalon Clock Sink Signal Roles

A clock sink provides a timing reference for other interfaces and internal logic.

Table 1. Clock Sink Signal Roles

Signal Role	Width	Direction	Required	Description
clk	1	Input	Yes	A clock signal. Provides synchronization for internal logic and for other interfaces.

Intel Corporation. All rights reserved. Intel, the Intel logo, Altera, Arria, Cyclone, Enpirion, MAX, Nios, Quartus and Stratix words and logos are trademarks of Intel Corporation or its subsidiaries in the U.S. and/or other countries. Intel warrants performance of its FPGA and semiconductor products to current specifications in accordance with Intel's standard warranty, but reserves the right to make changes to any products and services at any time without notice. Intel assumes no responsibility or liability arising out of the application or use of any information, product, or service described herein except as expressly agreed to in writing by Intel. Intel customers are advised to obtain the latest version of device specifications before relying on any published information and before placing orders for products or services.

*Other names and brands may be claimed as the property of others.



2.2. Clock Sink Properties

Table 2. Clock Sink Properties

Name	Default Value	Legal Values	Description
clockRate	0	0–2 ³² –1	Indicates the frequency in Hz of the clock sink interface. If 0, the clock rate allows any frequency. If non-zero, Platform Designer issues a warning if the connected clock source is not the specified frequency.

2.3. Associated Clock Interfaces

All synchronous interfaces have an `associatedClock` property that specifies which clock source on the component is used as a synchronization reference for the interface. This property is illustrated in the following figure.

Figure 4. associatedClock Property

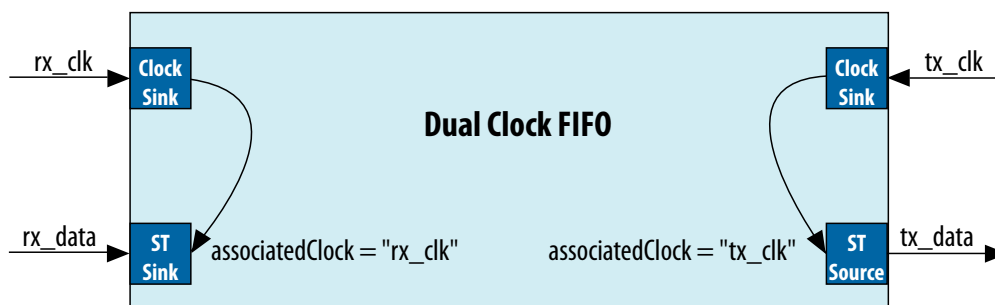

2.4. Avalon Clock Source Signal Roles

An Avalon Clock source interface drives a clock signal out of a component.

Table 3. Clock Source Signal Roles

Signal Role	Width	Direction	Required	Description
clk	1	Output	Yes	An output clock signal.

2.5. Clock Source Properties

Table 4. Clock Source Properties

Name	Default Value	Legal Values	Description
associatedDirectClock	N/A	an input clock name	The name of the clock input that directly drives this clock output, if any.
clockRate	0	0–2 ³² –1	Indicates the frequency in Hz at which the clock output is driven.
clockRateKnown	false	true, false	Indicates whether or not the clock frequency is known. If the clock frequency is known, this information can be used to customize other components in the system.



2.6. Reset Sink

Table 5. Reset Input Signal Roles

The `reset_req` signal is an optional signal that you can use to prevent memory content corruption by performing reset handshake prior to an asynchronous reset assertion.

Signal Role	Width	Direction	Required	Description
<code>reset</code> , <code>reset_n</code>	1	Input	Yes	Resets the internal logic of an interface or component to a user-defined state. The synchronous properties of the reset are defined by the <code>synchronousEdges</code> parameter.
<code>reset_req</code>	1	input	No	Early indication of reset signal. This signal acts as a least a one-cycle warning of pending reset for ROM primitives. Use <code>reset_req</code> to disable the clock enable or mask the address bus of an on-chip memory, to prevent the address from transitioning when an asynchronous reset input is asserted.

2.7. Reset Sink Interface Properties

Table 6. Reset Input Signal Roles

Name	Default Value	Legal Values	Description
<code>associatedClock</code>	N/A	a clock name	The name of a clock to which this interface is synchronized. Required if the value of <code>synchronousEdges</code> is <code>DEASSERT</code> or <code>BOTH</code> .
<code>synchronousEdges</code>	<code>DEASSERT</code>	<code>NONE</code> <code>DEASSERT</code> <code>BOTH</code>	Indicates the type of synchronization the reset input requires. The following values are defined: <ul style="list-style-type: none"> <code>NONE</code>—no synchronization is required because the component includes logic for internal synchronization of the reset signal. <code>DEASSERT</code>—the reset assertion is asynchronous and deassertion is synchronous. <code>BOTH</code>—reset assertion and deassertion are synchronous.

2.8. Associated Reset Interfaces

All synchronous interfaces have an `associatedReset` property that specifies which reset signal resets the interface logic.

2.9. Reset Source

Table 7. Reset Output Signal Roles

The `reset_req` signal is an optional signal that you can use to prevent memory content corruption by performing reset handshake prior to an asynchronous reset assertion.

Signal Role	Width	Direction	Required	Description
<code>reset</code> <code>reset_n</code>	1	Output	Yes	Resets the internal logic of an interface or component to a user-defined state.
<code>reset_req</code>	1	Output	Optional	Enables reset request generation, which is an early signal that is asserted before reset assertion. Once asserted, this cannot be deasserted until the reset is completed.



2.10. Reset Source Interface Properties

Table 8. Reset Interface Properties

Name	Default Value	Legal Values	Description
associatedClock	N/A	a clock name	The name of a clock to which this interface synchronized. Required if the value of synchronousEdges is DEASSERT or BOTH.
associatedDirectReset	N/A	a reset name	The name of the reset input that directly drives this reset source through a one-to-one link.
associatedResetSinks	N/A	a reset name	Specifies reset inputs which eventually cause a reset source to assert reset. For example, a reset synchronizer ORs a number of reset inputs to generate a reset output.
synchronousEdges	DEASSERT	NONE DEASSERT BOTH	Indicates the reset output's synchronization. The following values are defined: <ul style="list-style-type: none"> NONE—The reset interface is asynchronous. DEASSERT—the reset assertion is asynchronous and deassertion is synchronous. BOTH—reset assertion and deassertion are synchronous.



3. Avalon Memory-Mapped Interfaces

3.1. Introduction to Avalon Memory-Mapped Interfaces

You can use Avalon Memory-Mapped (Avalon-MM) interfaces to implement read and write interfaces for master and slave components. The following are examples of components that typically include memory-mapped interfaces:

- Microprocessors
- Memories
- UARTs
- DMAs
- Timers

Avalon-MM interfaces range from simple to complex. For example, SRAM interfaces that have fixed-cycle read and write transfers have simple Avalon-MM interfaces. Pipelined interfaces capable of burst transfers are complex.



Figure 5. Focus on Avalon-MM Slave Transfers

The following figure shows a typical system, highlighting the Avalon-MM slave interface connection to the interconnect fabric.

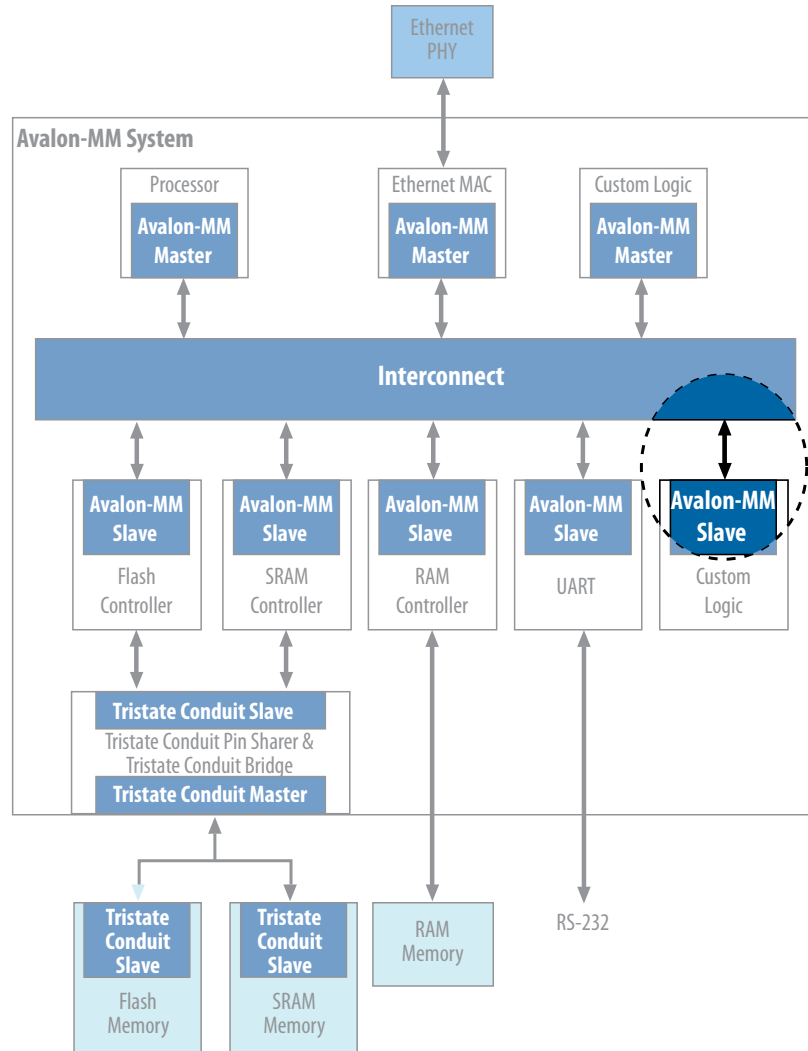

Avalon-MM components typically include only the signals required for the component logic.

Figure 6. Example Slave Component

The 16-bit general-purpose I/O peripheral shown in the following figure only responds to write requests. This component includes only the slave signals required for write transfers.

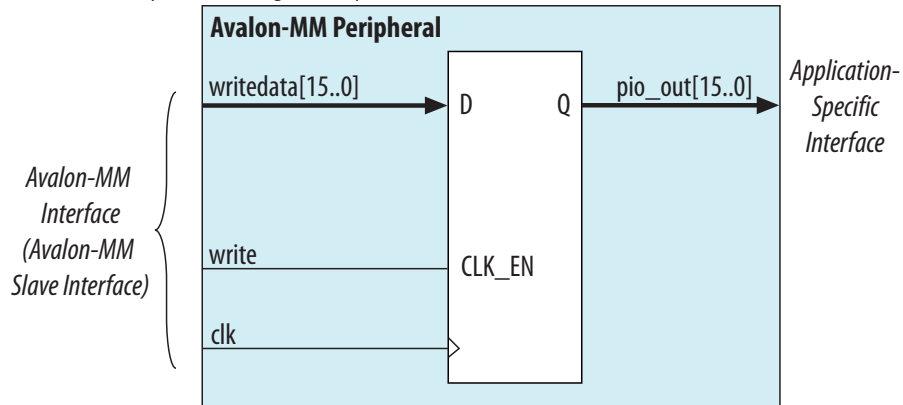

Each signal in an Avalon-MM slave corresponds to exactly one Avalon-MM signal role. An Avalon-MM interface can use only one instance of each signal role.

3.2. Avalon Memory-Mapped Interface Signal Roles

Signal roles define the signal types that are allowed on Avalon-MM master and slave ports.

This specification does not require all signals to exist in an Avalon-MM interface. There is no one signal that is always required. The minimum requirements for an Avalon-MM interface are `readdata` for a read-only interface, or `writedata` and `write` for a write-only interface.

The following table lists signal roles for the Avalon-MM interface:

Table 9. Avalon-MM Signal Roles

Some Avalon-MM signals can be active high or active low. When active low, the signal name ends with `_n`.

Signal Role	Width	Direction	Required	Description
Fundamental Signals				
<code>address</code>	1 - 64	Master → Slave	No	Masters: By default, the <code>address</code> signal represents a byte address. The value of the address must be aligned to the data width. To write to specific bytes within a data word, the master must use the <code>byteenable</code> signal. Refer to the <code>addressUnits</code> interface property for word addressing. Slaves: By default, the interconnect translates the byte address into a word address in the slave's address space. Each slave access is for a word of data from the perspective of the slave. For example, <code>address = 0</code> selects the first word of the slave. <code>address = 1</code> selects the second word of the slave. Refer to the <code>addressUnits</code> interface property for byte addressing.
<code>byteenable</code>	2, 4, 8, 16, 32, 64, 128	Master → Slave	No	Enables one or more specific byte lanes during transfers on interfaces of width greater than 8 bits. Each bit in <code>byteenable</code> corresponds to a byte in

continued...



Signal Role	Width	Direction	Required	Description
byteenable_ n				<p>writedata and readdata. The master bit <n> of byteenable indicates whether byte <n> is being written to. During writes, byteenables specify which bytes are being written to. Other bytes should be ignored by the slave. During reads, byteenables indicate which bytes the master is reading. Slaves that simply return readdata with no side effects are free to ignore byteenables during reads. If an interface does not have a byteenable signal, the transfer proceeds as if all byteenables are asserted.</p> <p>When more than one bit of the byteenable signal is asserted, all asserted lanes are adjacent. The number of adjacent lines must be a power of 2. The specified bytes must be aligned on an address boundary for the size of the data. For example, the following values are legal for a 32-bit slave:</p> <ul style="list-style-type: none"> • 1111 writes full 32 bits • 0011 writes lower 2 bytes • 1100 writes upper 2 bytes • 0001 writes byte 0 only • 0010 writes byte 1 only • 0100 writes byte 2 only • 1000 writes byte 3 only <p>To avoid unintended side effects, use the byteenable signal in systems with different word sizes.</p> <p><i>Note:</i> The AXI interface supports unaligned accesses while Avalon-MM does not. Unaligned accesses going from an AXI master to an Avalon-MM slave may result in an illegal transaction. To avoid this issue, only use aligned accesses to Avalon-MM slaves.</p>
debugaccess	1	Master → Slave	No	When asserted, allows the Nios II processor to write on-chip memories configured as ROMs.
read read_n	1	Master → Slave	No	Asserted to indicate a read transfer. If present, readdata is required.
readdata	8, 16, 32, 64, 128, 256, 512, 1024	Slave → Master	No	The readdata driven from the slave to the master in response to a read transfer. Required for interfaces that support reads.
response [1:0]	2	Slave → Master	No	<p>The response signal is an optional signal that carries the response status.</p> <p><i>Note:</i> Because the signal is shared, an interface cannot issue or accept a write response and a read response in the same clock cycle.</p> <ul style="list-style-type: none"> • 00: OKAY—Successful response for a transaction. • 01: RESERVED—Encoding is reserved. • 10: SLAVEERROR—Error from an endpoint slave. Indicates an unsuccessful transaction. • 11: DECODEERROR—Indicates attempted access to an undefined location.

continued...

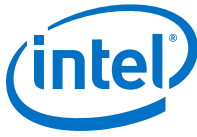

Signal Role	Width	Direction	Required	Description
				<p>For read responses:</p> <ul style="list-style-type: none"> One response is sent with each <code>readdata</code>. A read burst length of N results in N responses. Fewer responses are not valid, even in the event of an error. The response signal value may be different for each <code>readdata</code> in the burst. The interface must have read control signals. Pipeline support is possible with the <code>readdatavalid</code> signal. On read errors, the corresponding <code>readdata</code> is "don't care". <p>For write responses:</p> <ul style="list-style-type: none"> One write response must be sent for each write command. A write burst results in only one response, which must be sent after the final write transfer in the burst is accepted. If <code>writeresponsevalid</code> is present, all write commands must be completed with write responses."
<code>write</code> <code>write_n</code>	1	Master → Slave	No	Asserted to indicate a write transfer. If present, <code>writedata</code> is required.
<code>writedata</code>	8, 16, 32, 64, 128, 256, 512, 1024	Master → Slave	No	Data for write transfers. The width must be the same as the width of <code>readdata</code> if both are present. Required for interfaces that support writes.
Wait-State Signals				
<code>lock</code>	1	Master → Slave	No	<p><code>lock</code> ensures that once a master wins arbitration, the winning master maintains access to the slave for multiple transactions. <code>lock</code> asserts coincident with the first <code>read</code> or <code>write</code> of a locked sequence of transactions. <code>lock</code> deasserts on the final transaction of a locked sequence of transactions. <code>lock</code> assertion does not guarantee that arbitration is won. After the lock-asserting master has been granted, that master retains grant until <code>lock</code> is deasserted.</p> <p>A master equipped with <code>lock</code> cannot be a burst master. Arbitration priority values for lock-equipped masters are ignored.</p> <p><code>lock</code> is particularly useful for read-modify-write (RMW) operations. The typical read-modify-write operation includes the following steps:</p> <ol style="list-style-type: none"> Master A asserts <code>lock</code> and reads 32-bit data that has multiple bit fields. Master A deasserts <code>lock</code>, changes one bit field, and writes the 32-bit data back. <p><code>lock</code> prevents master B from performing a write between Master A's read and write.</p>
<code>waitrequest</code> <code>waitrequest_n</code>	1	Slave → Master	No	A slave asserts <code>waitrequest</code> when unable to respond to a <code>read</code> or <code>write</code> request. Forces the master to wait until the interconnect is ready to proceed with the transfer. At the start of all transfers, a master initiates the transfer and waits until <code>waitrequest</code> is deasserted. A master must make no assumption about the assertion state of
<i>continued...</i>				

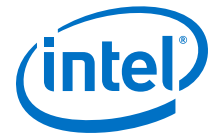

Signal Role	Width	Direction	Required	Description
				<p><code>waitrequest</code> when the master is idle: <code>waitrequest</code> may be high or low, depending on system properties.</p> <p>When <code>waitrequest</code> is asserted, master control signals to the slave must remain constant with the exception of <code>beginbursttransfer</code>. For a timing diagram illustrating the <code>beginbursttransfer</code> signal, refer to the figure in <i>Read Bursts</i>.</p> <p>An Avalon-MM slave may assert <code>waitrequest</code> during idle cycles. An Avalon-MM master may initiate a transaction when <code>waitrequest</code> is asserted and wait for that signal to be deasserted. To avoid system lockup, a slave device should assert <code>waitrequest</code> when in reset.</p>
Pipeline Signals				
<code>readdatavalid</code> <code>readdatavalid_n</code>	1	Slave → Master	No	<p>Used for variable-latency, pipelined read transfers. When asserted, indicates that the <code>readdata</code> signal contains valid data. For a read burst with <code>burstcount</code> value $<n>$, the <code>readdatavalid</code> signal must be asserted $<n>$ times, once for each <code>readdata</code> item. There must be at least one cycle of latency between acceptance of the <code>read</code> and assertion of <code>readdatavalid</code>. For a timing diagram illustrating the <code>readdatavalid</code> signal, refer to <i>Pipelined Read Transfer with Variable Latency</i>.</p> <p>A slave may assert <code>readdatavalid</code> to transfer data to the master independently of whether or not the slave is stalling a new command with <code>waitrequest</code>.</p> <p>Required if the master supports pipelined reads. Bursting masters with read functionality must include the <code>readdatavalid</code> signal.</p>
<code>writeresponsevalid</code>	1	Slave → Master	No	<p>An optional signal. If present, the interface issues write responses for write commands.</p> <p>When asserted, the value on the response signal is a valid write response.</p> <p><code>Writeresponsevalid</code> is only asserted one clock cycle or more after the write command is accepted. There is at least a one clock cycle latency from command acceptance to assertion of <code>writeresponsevalid</code>.</p>
Burst Signals				
<code>burstcount</code>	1 – 11	Master → Slave	No	<p>Used by bursting masters to indicate the number of transfers in each burst. The value of the maximum <code>burstcount</code> parameter must be a power of 2. A <code>burstcount</code> interface of width $<n>$ can encode a max burst of size $2^{(<n>-1)}$. For example, a 4-bit <code>burstcount</code> signal can support a maximum burst count of 8. The minimum <code>burstcount</code> is 1. The <code>constantBurstBehavior</code> property controls the timing of the <code>burstcount</code> signal. Bursting masters with read functionality must include the <code>readdatavalid</code> signal.</p>
<i>continued...</i>				



Signal Role	Width	Direction	Required	Description
				<p>For bursting masters and slaves using byte addresses, the following restriction applies to the width of the address:</p> <pre><address_w> >= <burstcount_w> + log₂(<symbols_per_word_of_interface>)</pre> <p>For bursting masters and slaves using word addresses, the log₂ term above is omitted.</p>
beginbursttransfer	1	Interconnect → Slave	No	<p>Asserted for the first cycle of a burst to indicate when a burst transfer is starting. This signal is deasserted after one cycle regardless of the value of waitrequest. For a timing diagram illustrating beginbursttransfer, refer to the figure in <i>Read Bursts</i>.</p> <p>beginbursttransfer is optional. A slave can always internally calculate the start of the next write burst transaction by counting data transfers.</p> <p>Warning: do not use this signal. This signal exists to support legacy memory controllers.</p>

3.3. Interface Properties

Table 10. Avalon-MM Interface Properties

Name	Default Value	Legal Values	Description
addressUnits	Master - symbols Slave - words	words, symbols	Specifies the unit for addresses. A symbol is typically a byte. Refer to the definition of address in the <i>Avalon Memory-Mapped Interface Signal Types</i> table for the typical use of this property.
alwaysBurstMaxBurst	false	true, false	When true, indicates that the master always issues the maximum-length burst. The maximum burst length is $2^{\text{burstcount_width} - 1}$. This parameter has no effect for Avalon-MM slave interfaces.
burstcountUnits	words	words, symbols	This property specifies the units for the burstcount signal. For symbols, the burstcount value is interpreted as the number of symbols (bytes) in the burst. For words, the burstcount value is interpreted as the number of word transfers in the burst.
burstOnBurstBoundariesOnly	false	true, false	If true, burst transfers presented to this interface begin at addresses which are multiples of the burst size in bytes.
constantBurstBehavior	Master - false Slave - false	true, false	<p>Masters: When true, declares that the master holds address and burstcount constant throughout a burst transaction. When false (default), declares that the master holds address and burstcount constant only for the first beat of a burst.</p> <p>Slaves: When true, declares that the slave expects address and burstcount to be held constant throughout a burst. When false (default), declares that the slave samples address and burstcount only on the first beat of a burst.</p>

continued...



Name	Default Value	Legal Values	Description
holdTime(1)	0	0 – 1000 cycles	Specifies time in timingUnits between the deassertion of write and the deassertion of address and data. (Only applies to write transactions.)
linewrapBursts	false	true, false	Some memory devices implement a wrapping burst instead of an incrementing burst. When a wrapping burst reaches a burst boundary, the address wraps back to the previous burst boundary. Only the low-order bits are required for address counting. For example, a wrapping burst to address 0xC with burst boundaries every 32 bytes across a 32-bit interface writes to the following addresses: <ul style="list-style-type: none"> • 0xC • 0x10 • 0x14 • 0x18 • 0x1C • 0x0 • 0x4 • 0x8
maximumPendingReadTransactions (1)	1(2)	1 – 64	Slaves: This parameter is the maximum number of pending reads that the slave can queue. For a timing diagram that illustrates this property, refer to Figure 3-5 on page 3-13 . The value must be non-zero for any slave with the readdatavalid signal. Refer to Pipelined Read Transfer with Variable Latency on page 27 for additional information about using waitrequest and readdatavalid with multiple outstanding reads. Masters: This property is the maximum number of outstanding read transactions that the master can generate. Do not set this parameter to 0. (For backwards compatibility, the software supports a parameter setting of 0. However, you should not use this setting in new designs).
maximumPendingWriteTransactions	0	1 – 64	The maximum number of pending non-posted writes that a slave can accept or a master can issue. A slave asserts waitrequest once the interconnect reaches this limit, and the master stops issuing commands. The default value is 0, which allows unlimited pending write transactions for a master that supports write responses. A slave that supports write responses must set this to a non-zero value.
minimumResponseLatency	1		For interfaces that support readdatavalid or writeresponsevalid, specifies the minimum number of cycles between a read or write command and the response to the command.
readLatency(1)	0	0 – 63	Read latency for fixed-latency Avalon-MM slaves. For a timing diagram that uses a fixed latency read, refer to Figure 13 on page 29. Avalon-MM slaves that are fixed latency must provide a value for this interface property. Avalon-MM slaves that are variable latency use the readdatavalid signal to specify valid data.
readWaitTime(1)	1	0 – 1000 cycles	For interfaces that do not use the waitrequest signal, readWaitTime indicates the timing in timingUnits before the slave accepts a read command. The timing is as if the slave asserted waitrequest for readWaitTime cycles.

continued...



Name	Default Value	Legal Values	Description
setupTime(1)	0	0 – 1000 cycles	Specifies time in timingUnits between the assertion of address and data and assertion of read or write.
timingUnits(1)	cycles	cycles, nanoseconds	Specifies the units for setupTime, holdTime, writeWaitTime and readWaitTime. Use cycles for synchronous devices and nanoseconds for asynchronous devices. Almost all Avalon-MM slave devices are synchronous. An Avalon-MM component that bridges from an Avalon-MM slave interface to an off-chip device may be asynchronous. That off-chip device might have a fixed settling time for bus turnaround.
waitrequestAllowance	0		Specifies the number of transfers that can be issued or accepted after waitrequest is asserted. When the waitrequestAllowance is 0, the write, read and waitrequest signals maintain their existing behavior as described in the <i>Avalon-MM Signal Roles</i> table. When the waitrequestAllowance is greater than 0, every clock cycle on which write or read is asserted counts as a command transfer. Once waitrequest is asserted, only waitrequestAllowance more command transfers are legal while waitrequest remains asserted. After the waitrequestAllowance is reached, write and read must remain deasserted for as long as waitrequest is asserted. Once waitrequestdeasserts, transfers may resume at any time without restrictions until waitrequest asserts again. At this time, waitrequestAllowance more transfers may complete while waitrequest remains asserted.
writeWaitTime(1)	0	0 – 1000 Cycles	For interfaces that do not use the waitrequest signal, writeWaitTime specifies the timing in timingUnits before a slave accepts a write. The timing is as if the slave asserted waitrequest for writeWaitTime cycles or nanoseconds. For a timing diagram that illustrates the use of writeWaitTime, refer to Figure 3-4 on page 3-12 .
Interface Relationship Properties			
associatedClock	N/A	N/A	Name of the clock interface to which this Avalon-MM interface is synchronous.
associatedReset	N/A	N/A	Name of the reset interface which resets the logic on this Avalon-MM interface.
bridgesToMaster	0	Avalon-MM Master name on the same component	An Avalon-MM bridge consists of a slave and a master, and has the property that an access to the slave requesting a particular byte or bytes causes the same byte or bytes to be requested by the master. The Avalon-MM Pipeline Bridge in the Platform Designer component library implements this functionality.
Notes:			
<ol style="list-style-type: none"> Although this property characterizes a slave device, masters can declare this property to enable direct connections between matching master and slave interfaces. If a slave interface accepts more read transfers than allowed, the interconnect pending read FIFO may overflow with unpredictable results. The slave may lose readdata or route readdata to the wrong master interface. Or, the system may lock up. The slave interface must assert waitrequest to prevent this overflow. 			

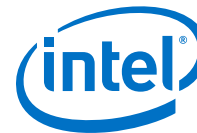

Related Information

- [Avalon Memory-Mapped Interface Signal Roles](#) on page 14
- [Read and Write Responses](#) on page 33
- [Read and Write Responses](#)
Specifies the conditions under which Platform Designer merges read and writes responses.

3.4. Timing

The Avalon-MM interface is synchronous. Each Avalon-MM interface is synchronized to an associated clock interface. Signals may be combinational if they are driven from the outputs of registers that are synchronous to the clock signal. This specification does not dictate how or when signals transition between clock edges. Timing diagrams are devoid of fine-grained timing information.

3.5. Transfers

This section defines two basic concepts before introducing the transfer types:

- **Transfer**—A transfer is a read or write operation of a word or one or more symbol of data. Transfers occur between an Avalon-MM interface and the interconnect. Transfers take one or more clock cycles to complete.
Both masters and slaves are part of a transfer. The Avalon-MM master initiates the transfer and the Avalon-MM slave responds.
- **Master-slave pair**—This term refers to the master interface and slave interface involved in a transfer. During a transfer, the master interface control and data signals pass through the interconnect fabric and interact with the slave interface.

3.5.1. Typical Read and Write Transfers

This section describes a typical Avalon-MM interface that supports read and write transfers with slave-controlled `waitrequest`. The slave can stall the interconnect for as many cycles as required by asserting the `waitrequest` signal. If a slave uses `waitrequest` for either read or write transfers, the slave must use `waitrequest` for both.

A slave typically receives `address`, `byteenable`, `read` or `write`, and `writedata` after the rising edge of the clock. A slave asserts `waitrequest` before the rising clock edge to hold off transfers. When the slave asserts `waitrequest`, the transfer is delayed. While `waitrequest` is asserted, the address and other control signals are held constant. Transfers complete on the rising edge of the first `clk` after the slave interface deasserts `waitrequest`.

There is no limit on how long a slave interface can stall. Therefore, you must ensure that a slave interface does not assert `waitrequest` indefinitely. The following figure shows `read` and `write` transfers using `waitrequest`.

Note: `waitrequest` can be decoupled from the read and write request signals. `waitrequest` may be asserted during idle cycles. An Avalon-MM master may initiate a transaction when `waitrequest` is asserted and wait for that signal to be deasserted. Decoupling `waitrequest` from read and write requests may improve system timing. Decoupling eliminates a combinational loop including the read, write, and `waitrequest` signals. If even more decoupling is required, use the `waitrequestAllowance` property. `waitrequestAllowance` is available starting with the Quartus® Prime Pro v17.1 Stratix® 10 ES Editions release.

Figure 7. Read and Write Transfers with Waitrequest

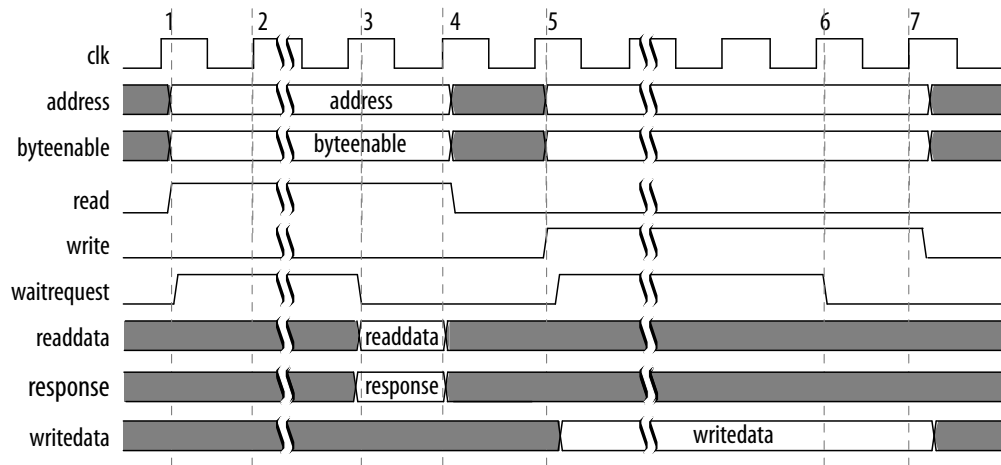

The numbers in this timing diagram, mark the following transitions:

1. `address`, `byteenable`, and `read` are asserted after the rising edge of `clk`. The slave asserts `waitrequest`, stalling the transfer.
2. `waitrequest` is sampled. Because `waitrequest` is asserted, the cycle becomes a wait-state. `address`, `read`, `write`, and `byteenable` remain constant.
3. The slave deasserts `waitrequest` after the rising edge of `clk`. The slave asserts `readdata` and `response`.
4. The master samples `readdata`, `response` and deasserted `waitrequest` completing the transfer.
5. `address`, `writedata`, `byteenable`, and `write` signals are asserted after the rising edge of `clk`. The slave asserts `waitrequest` stalling the transfer.
6. The slave deasserts `waitrequest` after the rising edge of `clk`.
7. The slave captures write data ending the transfer.



3.5.2. Transfers Using the waitrequestAllowance Property

The `waitrequestAllowance` property specifies the number of transfers an Avalon-MM master can issue or an Avalon-MM slave must accept after the `waitrequest` signal is asserted. `waitrequestAllowance` is available starting with the Intel® Quartus Prime 17.1 software release.

The default value of `waitrequestAllowance` is 0, which corresponds to the behavior described in [Typical Read and Write Transfers](#) on page 21 where `waitrequest` assertion stops the current transfer from being issued or accepted.

An Avalon-MM slave with a `waitrequestAllowance` greater than 0 would typically assert `waitrequest` when its internal buffer can only accept `waitrequestAllowance` more entries before becoming full. Avalon-MM masters with a `waitrequestAllowance` greater than 0 have `waitrequestAllowance` additional cycles to stop sending transfers, which allows more pipelining in the master logic. The master must deassert the `read` or `write` signal when the `waitrequestallowance` has been spent.

Values of `waitrequestAllowance` greater than 0 support high-speed design where immediate forms of backpressure may result in a drop in the maximum operating frequency (F_{MAX}) often due to combinatorial logic in the control path. An Avalon-MM slave must support all possible transfer timings that are legal for its `waitrequestAllowance` value. For example, a slave with `waitrequestAllowance` = 2 must be able to accept any of the master transfer waveforms shown in the following examples.

3.5.2.1. waitrequestAllowance Equals Two

The following timing diagram illustrates timing for an Avalon-MM master that has two clock cycles to start and stop sending transfers after the Avalon-MM slave deasserts or asserts `waitrequest`, respectively.

Figure 8. Master write: waitrequestAllowance Equals Two Clock Cycles

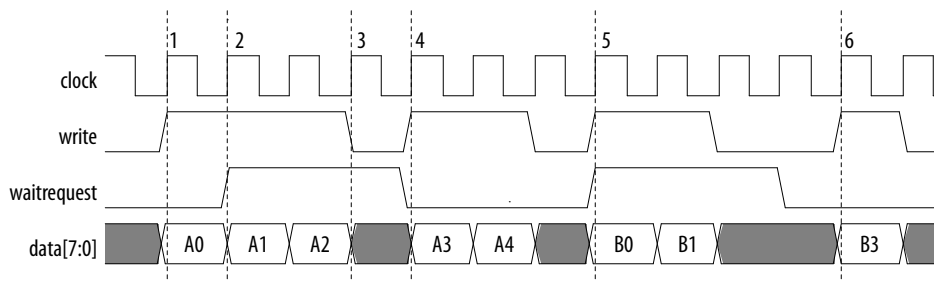

The markers in this figure mark the following events:

1. The Avalon-MM master drives `write` and data.
2. The Avalon-MM slave asserts `waitrequest`. Because the `waitrequestAllowance` is 2, the master is able to complete the 2 additional data transfers.
3. The master deasserts `write` as required because the slave is asserting `waitrequest` for a third cycle.

4. The Avalon-MM master drives `write` and `data`. The slave is not asserting `waitrequest`. The writes complete.
5. The Avalon master drives `write` and `data` even though the slave is asserting `waitrequest`. Because the `waitrequestAllowance` is 2 cycles, the write completes.
6. The Avalon master drives `write` and `data`. The slave is not asserting `waitrequest`. The write completes.

3.5.2.2. `waitrequestAllowance` Equals One

The following timing diagram illustrates timing for an Avalon-MM master that has one clock cycle to start and stop sending transfers after the Avalon-MM slave deasserts or asserts `waitrequest`, respectively.

Figure 9. Master Write: `waitrequestAllowance` Equals one Clock Cycle

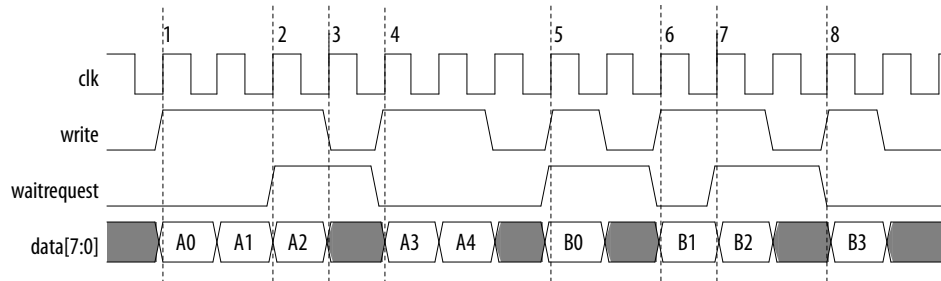

The numbers in this figure mark the following events:

1. The Avalon-MM master drives `write` and `data`.
2. The Avalon-MM slave asserts `waitrequest`. Because the `waitrequestAllowance` is 1, the master is able to complete the write.
3. The master deasserts `write` because the slave is asserting `waitrequest` for a second cycle.
4. The Avalon-MM master drives `write` and `data`. The slave is not asserting `waitrequest`. The writes complete.
5. The slave asserts `waitrequest`. Because the `waitrequestAllowance` is 1 cycle, the write completes.
6. Avalon-MM master drives `write` and `data`. The slave is not asserting `waitrequest`. The write completes.
7. The Avalon-MM slave asserts `waitrequest`. Because the `waitrequestAllowance` is 1, the master is able to complete one additional data transfer.
8. The Avalon master drives `write` and `data`. The slave is not asserting `waitrequest`. The write completes.

3.5.2.3. `waitrequestAllowance` Equals Two - Not Recommended

The following timing diagram illustrates timing for an Avalon-MM master that can send two transfers after `waitrequest` is asserted.



This timing is legal, but not recommended. In this example the master counts the number of transactions, instead of the number of clock cycles. This approach requires a counter that makes the implementation more complex and may affect timing closure. When the master uses the `waitrequest` signal and a constant number of cycles to determine when it can drive transactions as shown in the previous examples, the master starts or stops transactions on the basis of the registered signals.

Figure 10. `waitrequestAllowance` Equals Two Transfers

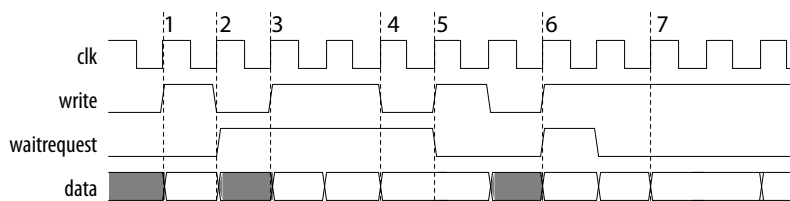

The numbers in this figure mark the following events:

1. The Avalon-MM master asserts `write` and drives data.
2. The Avalon-MM slave asserts `waitrequest`.
3. The Avalon-MM master drives `write` and data. Because the `waitrequestAllowance` is 2, the master drives data in 2 consecutive cycles.
4. The Avalon-MM master deasserts `write` because the master has spent the 2-transfer `waitrequestAllowance`.
5. The Avalon-MM master issues a write as soon as `waitrequest` is deasserted.
6. The Avalon-MM master drives `write` and data. The slave asserts `waitrequest` for 1 cycle.
7. In response to `waitrequest`, the Avalon-MM master holds data for 2 cycles.

3.5.2.4. `waitrequestAllowance` Compatibility for Avalon-MM Master and Slave Interfaces

Avalon-MM masters and slaves that support the `waitrequest` signal support backpressure. Masters with backpressure can always connect to slaves without backpressure. Masters without backpressure cannot connect to slaves with backpressure.

Table 11. `waitrequestAllowance` Compatibility for Avalon-MM Masters and Slaves

Master and Slave <code>waitrequestAllowance</code>	Compatibility
master = 0 slave = 0	Follows the same compatibility rules as standard Avalon-MM interfaces.
master = 0 slave > 0	Direct connections are not possible. Simple adaptation is required for the case of a master with a <code>waitrequest</code> signal. A connection is impossible if the master does not support the <code>waitrequest</code> signal.
master > 0 slave = 0	Direct connections are not possible. Adaptation (buffers) are required when connecting to a slave with a <code>waitrequest</code> signal or fixed wait states.
master > 0	No adaptation is required if the master's allowance \leq slave's allowance.

continued...



Master and Slave waitrequestAllowance	Compatibility
slave > 0	<p>If the master allowance < slave allowance, pipeline registers may be inserted. For point-to-point connections, you can add the pipeline registers on the command signals or the waitrequest signals. Up to <d> register stages can be inserted where <d> is the difference between the allowances.</p> <p>Connecting a master with a higher waitrequestAllowance than the slave requires buffering.</p>

3.5.2.5. waitrequestAllowance Error Conditions

Behavior is unpredictable for if an Avalon-MM interface violates the waitrequest allowance specification.

- If a master violates the waitrequestAllowance = <n> specification by sending more than <n> transfers, transfers may be dropped or data corruption may occur.
- If a slave advertises a larger waitrequestAllowance than is possible, some transfers may be dropped or data corruption may occur.

3.5.3. Read and Write Transfers with Fixed Wait-States

A slave can specify fixed wait-states using the readWaitTime and writeWaitTime properties. Using fixed wait-states is an alternative to using waitrequest to stall a transfer. The address and control signals (byteenable, read, and write) are held constant for the duration of the transfer. Setting readWaitTime or writeWaitTime to <n> is equivalent to asserting waitrequest for <n> cycles per transfer.

In the following figure, the slave has a writeWaitTime = 2 and readWaitTime = 1.

Figure 11. Read and Write Transfer with Fixed Wait-States at the Slave Interface

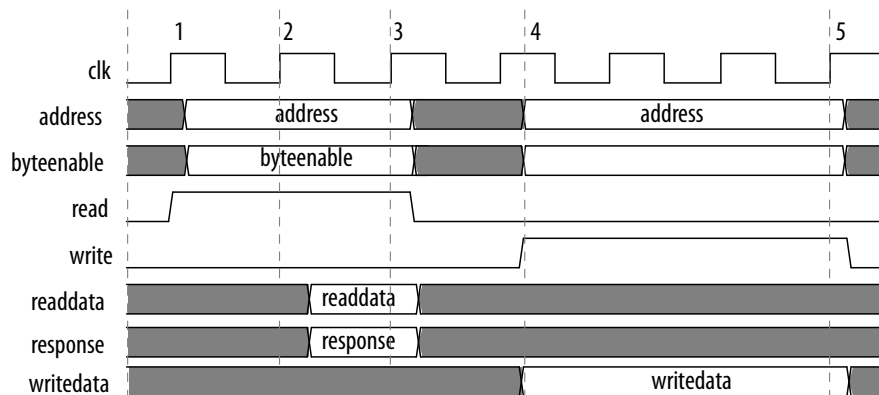



The numbers in this timing diagram mark the following transitions:

1. The master asserts `address` and `read` on the rising edge of `clk`.
2. The next rising edge of `clk` marks the end of the first and only wait-state cycle. The `readWaitTime` is 1.
3. The slave asserts `readdata` and `response` on the rising edge of `clk`. The read transfer ends.
4. `writedata`, `address`, `byteenable`, and `write` signals are available to the slave.
5. The write transfer ends after 2 wait-state cycles.

Transfers with a single wait-state are commonly used for multicycle off-chip peripherals. The peripheral captures address and control signals on the rising edge of `clk`. The peripheral has one full cycle to return data.

Components with zero wait-states are allowed. However, components with zero wait-states may decrease the achievable frequency. Zero wait-states require the component to generate the response in the same cycle that the request was presented.

3.5.4. Pipelined Transfers

Avalon-MM pipelined read transfers increase the throughput for synchronous slave devices that require several cycles to return data for the first access. Such devices can typically return one data value per cycle for some time thereafter. New pipelined read transfers can start before `readdata` for the previous transfers is returned.

A pipelined read transfer has an address phase and a data phase. A master initiates a transfer by presenting the address during the address phase. A slave fulfills the transfer by delivering the data during the data phase. The address phase for a new transfer (or multiple transfers) can begin before the data phase of a previous transfer completes. The delay is called pipeline latency. The pipeline latency is the duration from the end of the address phase to the beginning of the data phase.

Transfer timing for wait-states and pipeline latency have the following key differences:

- **Wait-states**—Wait-states determine the length of the address phase. Wait-states limit the maximum throughput of a port. If a slave requires one wait-state to respond to a transfer request, the port requires two clock cycles per transfer.
- **Pipeline Latency**—Pipeline latency determines the time until data is returned independently of the address phase. A pipelined slave with no wait-states can sustain one transfer per cycle. However, the slave may require several cycles of latency to return the first unit of data.

Wait-states and pipelined reads can be supported concurrently. Pipeline latency can be either fixed or variable.

3.5.4.1. Pipelined Read Transfer with Variable Latency

After capturing address and control signals, an Avalon-MM pipelined slave takes one or more cycles to produce data. A pipelined slave may have multiple pending read transfers at any given time. Variable-latency pipelined read transfers require one additional signal, `readdatavalid`. `readdatavalid` indicates when read data is valid. Variable-latency pipelined read transfers also include the same set of signals as

non-pipelined read transfers. Slave peripherals that use `readdatavalid` are considered pipelined with variable latency. The `readdata` and `readdatavalid` signals corresponding to a particular read command can be asserted the cycle after that read command is asserted, at the earliest.

The slave must return `readdata` in the same order that it accepted the read commands. Pipelined slave ports with variable latency must use `waitrequest`. The slave can assert `waitrequest` to stall transfers to maintain an acceptable number of pending transfers. A slave may assert `readdatavalid` to transfer data to the master independently of whether or not the slave is stalling a new command with `waitrequest`.

Note: The maximum number of pending transfers is a property of the slave interface. The interconnect fabric builds logic to route `readdata` to requesting masters using this number. The slave interface, not the interconnect fabric, must track the number of pending reads. The slave must assert `waitrequest` to prevent the number of pending reads from exceeding the maximum number. If a slave has `waitrequestAllowance > 0`, the slave must assert `waitrequest` early enough so that the total pending transfers, including those accepted while `waitrequest` is asserted, does not exceed the maximum number of pending transfers specified.

Figure 12. Pipelined Read Transfers with Variable Latency

The following figure shows several slave read transfers. The slave is pipelined with variable latency. In this figure, the slave can accept a maximum of two pending transfers. The slave uses `waitrequest` to avoid overrunning this maximum.

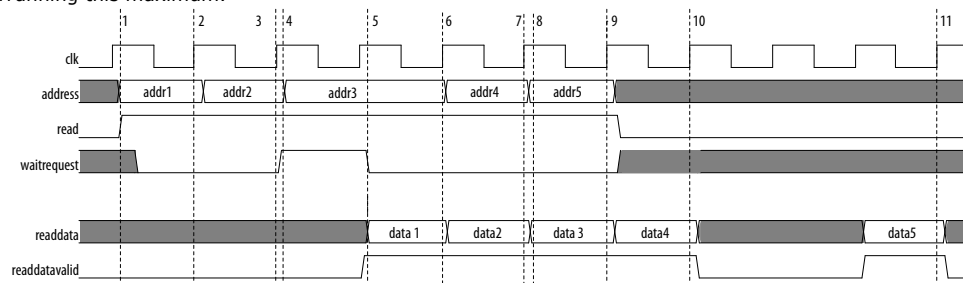

The numbers in this timing diagram, mark the following transitions:

1. The master asserts `address` and `read`, initiating a read transfer.
2. The slave captures `addr1`.
3. The slave captures `addr2`.
4. The slave asserts `waitrequest` because the slave has already accepted a maximum of two pending reads, causing the third transfer to stall.
5. The slave asserts `data1`, the response to `addr1`. The slave deasserts `waitrequest`.
6. The slave captures `addr3`. The interconnect captures `data1`. The interconnect captures `data1`.
7. The slave captures `addr4`. The interconnect captures `data2`.
8. The slave drives `readdatavalid` and `readdata` in response to the third read transfer.



9. The slave captures `addr5`. The interconnect captures `data3`. The `read` signal is deasserted. The value of `waitrequest` is no longer relevant.
10. The interconnect captures `data4`.
11. The slave drives `data5` and asserts `readdatavalid` completing the data phase for the final pending read transfer.

If the slave cannot handle a write transfer while processing pending read transfers, the slave must assert `waitrequest` and stall the write operation until the pending read transfers have completed. The Avalon-MM specification does not define the value of `readdata` in the event that a slave accepts a write transfer to the same address as a currently pending read transfer.

3.5.4.2. Pipelined Read Transfers with Fixed Latency

The address phase for fixed latency read transfers is identical to the variable latency case. After the address phase, a pipelined slave with fixed read latency takes a fixed number of clock cycles to return valid `readdata`. The `readWaitTime` property specifies the number of clock cycles to return valid `readdata`. The interconnect captures `readdata` on the appropriate rising clock edge, ending the data phase.

During the address phase, the slave can assert `waitrequest` to hold off the transfer. Or, the slave specifies the `readWaitTime` for a fixed number of wait states. The address phase ends on the next rising edge of `clk` after wait states, if any.

During the data phase, the slave drives `readdata` after a fixed latency. For a read latency of $\langle n \rangle$, the slave must present valid `readdata` on the $\langle nth \rangle$ rising edge of `clk` after the end of the address phase.

Figure 13. Pipelined Read Transfer with Fixed Latency of Two Cycles

The following figure shows multiple data transfers between a master and a pipelined slave. The slave drives `waitrequest` to stall transfers, and has a fixed read latency of 2 cycles.

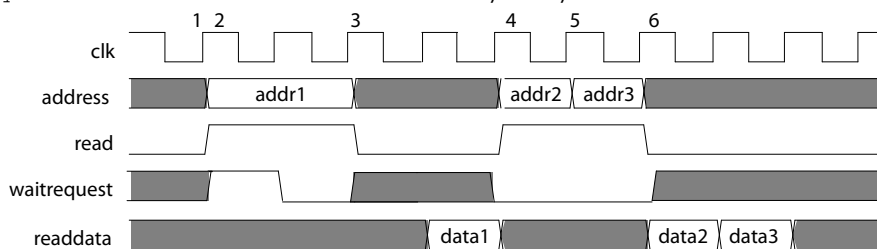

The numbers in this timing diagram, mark the following transitions:

1. A master initiates a read transfer by asserting `read` and `addr1`.
2. The slave asserts `waitrequest` to hold off the transfer for one cycle.
3. The slave captures `addr1` at the rising edge of `clk`. The address phase ends here.
4. The slave presents valid `readdata` after 2 cycles, ending the transfer.
5. `addr2` and `read` are asserted for a new read transfer.
6. The master initiates a third read transfer during the next cycle, before the data from the prior transfer is returned.



3.5.5. Burst Transfers

A burst executes multiple transfers as a unit, rather than treating every word independently. Bursts may increase throughput for slave ports that achieve greater efficiency when handling multiple words at a time, such as SDRAM. The net effect of bursting is to lock the arbitration for the duration of the burst. A bursting Avalon-MM interface that supports both reads and writes must support both read and write bursts.

Bursting Avalon-MM interfaces include a `burstcount` output signal. If a slave has a `burstcount` input, the slave is burst capable.

The `burstcount` signal behaves as follows:

- At the start of a burst, `burstcount` presents the number of sequential transfers in the burst.
- For width $\langle n \rangle$ of `burstcount`, the maximum burst length is $2^{\langle n \rangle - 1}$. The minimum legal burst length is one.

To support slave read bursts, a slave must also support:

- Wait states with the `waitrequest` signal.
- Pipelined transfers with variable latency with the `readdatavalid` signal.

At the start of a burst, the slave sees the `address` and a burst length value on `burstcount`. For a burst with an address of $\langle a \rangle$ and a `burstcount` value of $\langle b \rangle$, the slave must perform $\langle b \rangle$ consecutive transfers starting at address $\langle a \rangle$. The burst completes after the slave receives (write) or returns (read) the $\langle b^{\text{th}} \rangle$ word of data. The bursting slave must capture `address` and `burstcount` only once for each burst. The slave logic must infer the address for all but the first transfers in the burst. A slave can also use the input signal `beginbursttransfer`, which the interconnect asserts on the first cycle of each burst.

3.5.5.1. Write Bursts

These rules apply when a write burst begins with `burstcount` greater than one.

- When a `burstcount` of $\langle n \rangle$ is presented at the beginning of the burst, the slave must accept $\langle n \rangle$ successive units of `writedata` to complete the burst. Arbitration between the master-slave pair remains locked until the burst completes. This lock guarantees that no other master can execute transactions on the slave until the write burst completes.
- The slave must only capture `writedata` when `write` asserts. During the burst, the master can deassert `write` indicating that `writedata` is invalid. Deasserting `write` does not terminate the burst. The `write` deassertion delays the burst and no other master can access the slave, reducing the transfer efficiency.
- The slave delays a transfer by asserting `waitrequest` forcing `writedata`, `write`, `burstcount`, and `byteenable` to be held constant.



- The functionality of the `byteenable` signal is the same for bursting and non-bursting slaves. For a 32-bit master burst-writing to a 64-bit slave, starting at byte address 4, the first write transfer seen by the slave is at its address 0, with `byteenable = 8'b11110000`. The `byteenables` can change for different words of the burst.
- The `byteenable` signals do not all have to be asserted. A burst master writing partial words can use the `byteenable` signal to identify the data being written.
- The `constantBurstBehavior` property specifies the behavior of the burst signals.
 - When `constantBurstBehavior` is true for a master, the master holds address and `burstcount` stable throughout a burst. When true for a slave, `constantBurstBehavior` declares that the slave expects address and `burstcount` to be held stable throughout a burst.
 - When `constantBurstBehavior` is false, the master holds address and `burstcount` stable only for the first transaction of a burst. When `constantBurstBehavior` is false, the slave samples address and `burstcount` only on the first transaction of a burst.

Figure 14. Write Burst with `constantBurstBehavior` Set to False for Master and Slave

The following figure demonstrates a slave write burst of length 4. In this example, the slave asserts `waitrequest` twice delaying the burst.

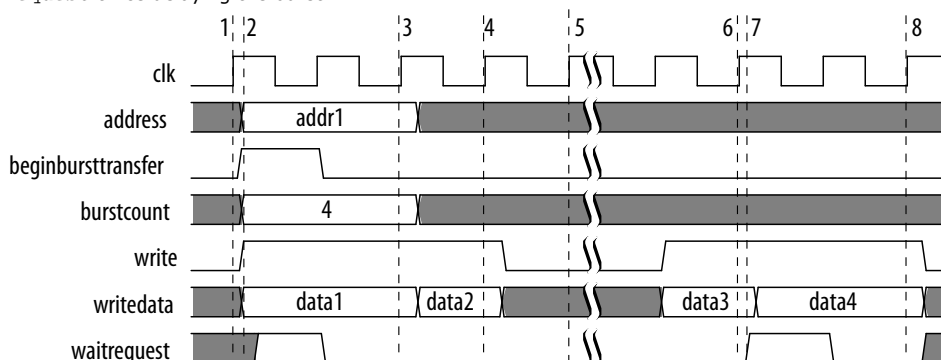

The numbers in this timing diagram, mark the following transitions:

1. The master asserts address, burstcount, write, and drives the first unit of writedata.
2. The slave immediately asserts waitrequest, indicating that the slave is not ready to proceed with the transfer.
3. waitrequest is low. The slave captures addr1, burstcount, and the first unit of writedata. On subsequent cycles of the transfer, address and burstcount are ignored.
4. The slave captures the second unit of data at the rising edge of clk.
5. The burst is paused while write is deasserted.



6. The slave captures the third unit of data at the rising edge of `clk`.
7. The slave asserts `waitrequest`. In response, all outputs are held constant through another clock cycle.
8. The slave captures the last unit of data on this rising edge of `clk`. The slave write burst ends.

In the figure above, the `beginbursttransfer` signal is asserted for the first clock cycle of a burst and is deasserted on the next clock cycle. Even if the slave asserts `waitrequest`, the `beginbursttransfer` signal is only asserted for the first clock cycle.

Related Information

[Interface Properties](#) on page 18

3.5.5.2. Read Bursts

Read bursts are similar to pipelined read transfers with variable latency. A read burst has distinct address and data phases. `readdatavalid` indicates when the slave is presenting valid `readdata`. Unlike pipelined read transfers, a single read burst address results in multiple data transfers.

These rules apply to read bursts:

- When a master connects directly to a slave, a `burstcount` of $\langle n \rangle$ means the slave must return $\langle n \rangle$ words of `readdata` to complete the burst. For cases where interconnect links the master and slave pair, the interconnect may suppress read commands sent from the master to the slave. For example, if the master sends a read command with a `byteenable` value of 0, the interconnect may suppress the read. As a result, the slave does not respond to the read command.
- The slave presents each word by providing `readdata` and asserting `readdatavalid` for a cycle. Deassertion of `readdatavalid` delays but does not terminate the burst data phase.
- For reads with a `burstcount` > 1 , Intel recommends asserting all `byteenables`.

Note: Intel recommends that burst capable slaves not have read side effects. (This specification does not guarantee how many bytes a master reads from the slave in order to satisfy a request.)



Figure 15. Read Burst

The following figure illustrates a system with two bursting masters accessing a slave. Note that Master B can drive a read request before the data has returned for Master A.

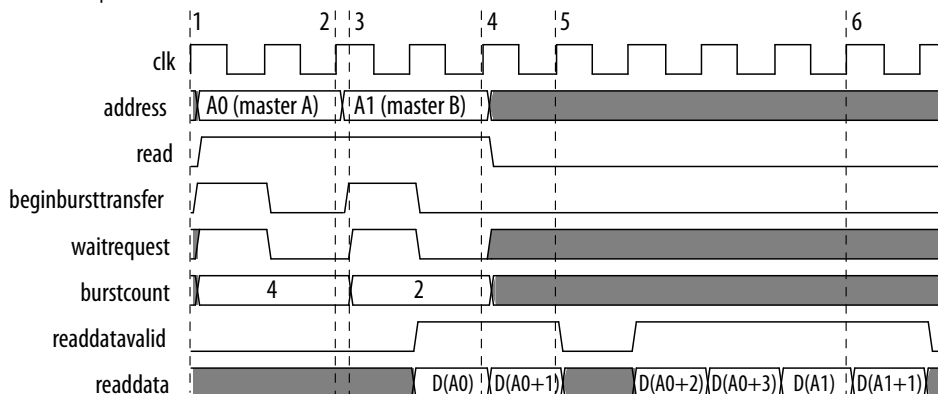

The numbers in this timing diagram, mark the following transitions:

1. Master A asserts address (A0), burstcount, and read after the rising edge of clk. The slave asserts waitrequest, causing all inputs except beginbursttransfer to be held constant through another clock cycle.
2. The slave captures A0 and burstcount at this rising edge of clk. A new transfer could start on the next cycle.
3. Master B drives address (A1), burstcount, and read. The slave asserts waitrequest, causing all inputs except beginbursttransfer to be held constant. The slave could have returned read data from the first read request at this time, at the earliest.
4. The slave presents valid readdata and asserts readdatavalid, transferring the first word of data for master A.
5. The second word for master A is transferred. The slave deasserts readdatavalid pausing the read burst. The slave port can keep readdatavalid deasserted for an arbitrary number of clock cycles.
6. The first word for master B is returned.

3.5.5.3. Line-Wrapped Bursts

Processors with instruction caches gain efficiency by using line-wrapped bursts. When a processor requests data that is not in the cache, the cache controller must refill the entire cache line. For a processor with a cache line size of 64 bytes, a cache miss causes 64 bytes to be read from memory. If the processor reads from address 0xC when the cache miss occurred, then an inefficient cache controller could issue a burst at address 0, resulting in data from read addresses 0x0, 0x4, 0x8, 0xC, 0x10, 0x14, 0x18, . . . 0x3C. The requested data is not available until the fourth read. With line-wrapping bursts, the address order is 0xC, 0x10, 0x14, 0x18, . . . 0x3C, 0x0, 0x4, and 0x8. The requested data is returned first. The entire cache line is eventually refilled from memory.

3.5.6. Read and Write Responses

For any Avalon-MM slave, commands must be processed in a hazard-free manner. Read and write responses issue in the order in which commands they were accepted.

3.5.6.1. Transaction Order for Avalon-MM Read and Write Responses (Masters and Slaves)

For any Avalon-MM master:

- The *Avalon Interface Specifications* guarantees that commands to the same slave reach the slave in command issue order, and the slave responds in command issue order.
- Different slaves may receive and respond to commands in a different order than which the master issues them. When successful, the slave responds in command issue order.
- Responses (if present) return in command issue order, regardless of whether the read or write commands are for the same or different slaves.
- The *Avalon Interface Specifications* does not guarantee transaction order between different masters.

3.5.6.2. Avalon-MM Read and Write Responses Timing Diagram

The following diagram shows command acceptance and command issue order for Avalon-MM read and write responses. Because the read and write interfaces share the response signal, an interface cannot issue or accept a write response and a read response in the same clock cycle.

Read responses, send one response for each `readdata`. A read burst length of $\langle N \rangle$ results in $\langle N \rangle$ responses.

Write responses, send one response for each write command. A write burst results in only one response. The slave interface sends the response after accepting the final write transfer in the burst. When an interface includes the `writeresponsevalid` signal, all write commands must complete with write responses.

Figure 16. Avalon-MM Read and Write Responses Timing Diagram

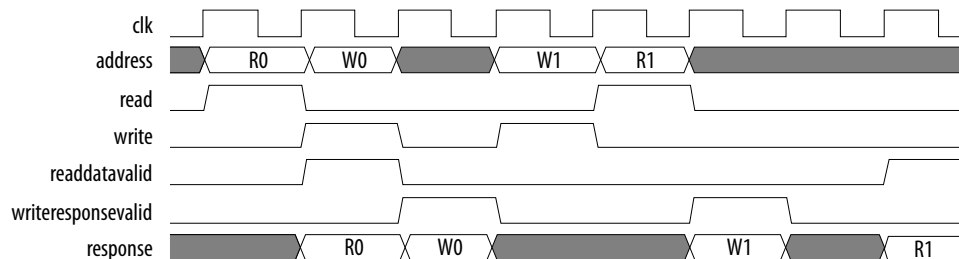

3.5.6.2.1. minimumResponseLatency Timing Diagram with readdatavalid or writeresponsevalid

For interfaces with `readdatavalid` or `writeresponsevalid`, the default a one-cycle `minimumResponseLatency` can lead to difficulty closing timing on Avalon-MM masters.

The following timing diagrams show the behavior for a `minimumResponseLatency` of 1 or 2 cycles. Note that the actual response latency can also be greater than the minimum allowed value as these timing diagrams illustrate.



Figure 17. `minimumResponseLatency` Equals One Cycle

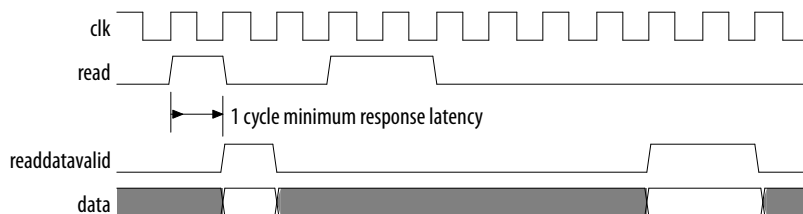
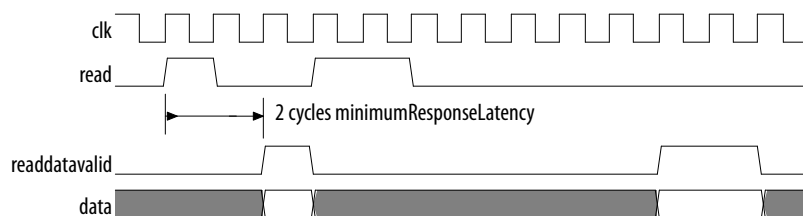

Figure 18. `minimumResponseLatency` Equals Two Cycles



Compatibility

Interfaces with the same `minimumResponseLatency` are interoperable without any adaptation. If the master has a higher `minimumResponseLatency` than the slave, use pipeline registers to compensate for the differences. The pipeline registers should delay `readdata` from the slave. If the slave has a higher `minimumResponseLatency` than the master, the interfaces are interoperable without adaptation.

3.6. Address Alignment

The interconnect only supports aligned accesses. A master can only issue addresses that are a multiple of its data width in symbols. A master can write partial words by deasserting some `byteenables`. For example, a write of 2 bytes at address 2 would have `4'b1100` for the `byteenables`.

3.7. Avalon-MM Slave Addressing

Dynamic bus sizing manages data during transfers between master-slave pairs of differing data widths. Slave data are aligned in contiguous bytes in the master address space.

If the master data width is wider than the slave data width, words in the master address space map to multiple locations in the slave address space. For example, a 32-bit master read from a 16-bit slave results in two read transfers on the slave side. The reads are to consecutive addresses.

If the master is narrower than the slave, then the interconnect manages the slave byte lanes. During master read transfers, the interconnect presents only the appropriate byte lanes of slave data to the narrower master. During master write transfers, the interconnect automatically asserts the `byteenable` signals to write data only to the specified slave byte lanes.



Slaves must have a data width of 8, 16, 32, 64, 128, 256, 512 or 1024 bits. The following table shows the alignment for slave data of various widths within a 32-bit master performing full-word accesses. In this table, `OFFSET[N]` refers to a slave word size offset into the slave address space.

Table 12. Dynamic Bus Sizing Master-to-Slave Address Mapping

Master Byte Address (1)	Access	32-Bit Master Data		
		When Accessing an 8-Bit Slave Interface	When Accessing a 16-Bit Slave Interface	When Accessing a 64-Bit Slave Interface
0x00	1	OFFSET[0] _{7..0}	OFFSET[0] _{15..0} (2)	OFFSET[0] _{31..0}
	2	OFFSET[1] _{7..0}	OFFSET[1] _{15..0}	—
	3	OFFSET[2] _{7..0}	—	—
	4	OFFSET[3] _{7..0}	—	—
0x04	1	OFFSET[4] _{7..0}	OFFSET[2] _{15..0}	OFFSET[0] _{63..32}
	2	OFFSET[5] _{7..0}	OFFSET[3] _{15..0}	—
	3	OFFSET[6] _{7..0}	—	—
	4	OFFSET[7] _{7..0}	—	—
0x08	1	OFFSET[8] _{7..0}	OFFSET[4] _{15..0}	OFFSET[1] _{31..0}
	2	OFFSET[9] _{7..0}	OFFSET[5] _{15..0}	—
	3	OFFSET[10] _{7..0}	—	—
	4	OFFSET[11] _{7..0}	—	—
0x0C	1	OFFSET[12] _{7..0}	OFFSET[6] _{15..0}	OFFSET[1] _{63..32}
	2	OFFSET[13] _{7..0}	OFFSET[7] _{15..0}	—
	3	OFFSET[14] _{7..0}	—	—
	4	OFFSET[15] _{7..0}	—	—
And so on		And so on	And so on	And so on
Notes:				
1. Although the master issues byte addresses, the master accesses full 32-bit words.				
2. For all slave entries, [<i><n></i>] is the word offset and the subscript values are the bits in the word.				



4. Avalon Interrupt Interfaces

Avalon Interrupt interfaces allow slave components to signal events to master components. For example, a DMA controller can interrupt a processor after completing a DMA transfer.

4.1. Interrupt Sender

An interrupt sender drives a single interrupt signal to an interrupt receiver. The timing of the `irq` signal must be synchronous to the rising edge of its associated clock. `irq` has no relationship to any transfer on any other interface. `irq` must be asserted until acknowledged on the associated Avalon-MM slave interface.

Interrupts are component specific. The receiver typically determines the appropriate response by reading an interrupt status register from an Avalon-MM slave interface.

4.1.1. Avalon Interrupt Sender Signal Roles

Table 13. Interrupt Sender Signal Roles

Signal Role	Width	Direction	Required	Description
<code>irq</code> <code>irq_n</code>	1-32	Output	Yes	Interrupt Request. An interrupt sender drives an interrupt signal to an interrupt receiver.

4.1.2. Interrupt Sender Properties

Table 14. Interrupt Sender Properties

Property Name	Default Value	Legal Values	Description
<code>associatedAddressablePoint</code>	N/A	Name of Avalon-MM slave on this component.	The name of the Avalon-MM slave interface that provides access to the registers to service the interrupt.
<code>associatedClock</code>	N/A	Name of a clock interface on this component.	The name of the clock interface to which this interrupt sender is synchronous. The sender and receiver may have different values for this property.
<code>associatedReset</code>	N/A	Name of a reset interface on this component.	The name of the reset interface to which this interrupt sender is synchronous.

4.2. Interrupt Receiver

An interrupt receiver interface receives interrupts from interrupt sender interfaces. Components with Avalon-MM master interfaces can include an interrupt receiver to detect interrupts asserted by slave components with interrupt sender interfaces. The interrupt receiver accepts interrupt requests from each interrupt sender as a separate bit.

4.2.1. Avalon Interrupt Receiver Signal Roles

Table 15. Interrupt Receiver Signal Roles

Signal Role	Width	Direction	Required	Description
irq	1-32	Input	Yes	irq is an $\langle n \rangle$ -bit vector, where each bit corresponds directly to one IRQ sender with no inherent assumption of priority.

4.2.2. Interrupt Receiver Properties

Table 16. Interrupt Receiver Properties

Property Name	Default Value	Legal Values	Description
associatedAddressablePoint	N/A	Name of Avalon-MM master interface	The name of the Avalon-MM master interface used to service interrupts received on this interface.
associatedClock	N/A	Name of an Avalon Clock interface	The name of the Avalon Clock interface to which this interrupt receiver is synchronous. The sender and receiver may have different values for this property.
associatedReset	N/A	Name of an Avalon Reset interface	The name of the reset interface to which this interrupt receiver is synchronous.

4.2.3. Interrupt Timing

The Avalon-MM master services the priority 0 interrupt before the priority 1 interrupt.

Figure 19. Interrupt Timing

In the following figure, interrupt 0 has higher priority. The interrupt receiver is in the process of handling int1 when int0 is asserted. The int0 handler is called and completes. Then, the int1 handler resumes. The diagram shows int0 deasserts at time 1. int1 deasserts at time 2.

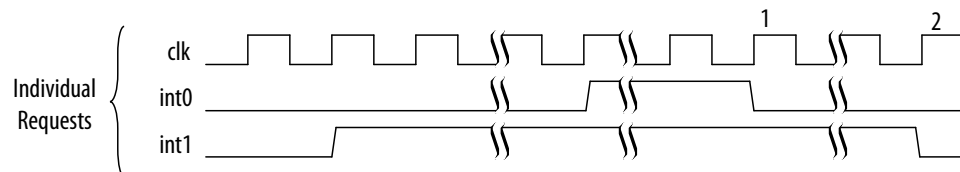

5. Avalon Streaming Interfaces

You can use Avalon Streaming (Avalon-ST) interfaces for components that drive high bandwidth, low latency, unidirectional data. Typical applications include multiplexed streams, packets, and DSP data. The Avalon-ST interface signals can describe traditional streaming interfaces supporting a single stream of data without knowledge of channels or packet boundaries. The interface can also support more complex protocols capable of burst and packet transfers with packets interleaved across multiple channels.

Figure 20. Avalon-ST Interface - Typical Application of the Avalon-ST Interface

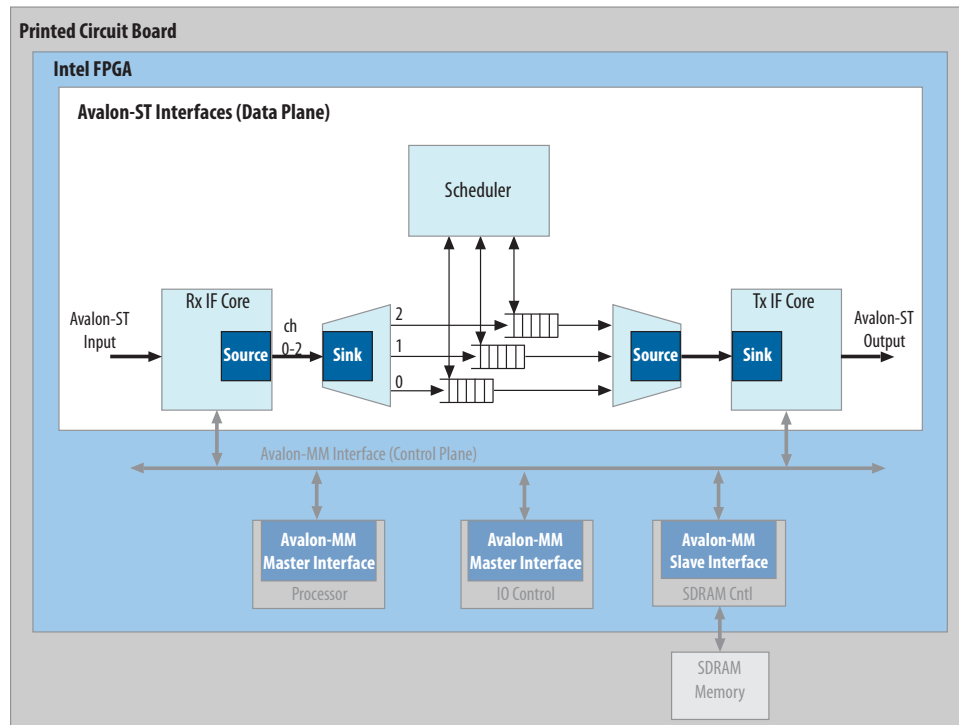

All Avalon-ST source and sink interfaces are not necessarily interoperable. However, if two interfaces provide compatible functions for the same application space, adapters are available to allow them to interoperate.



Avalon-ST interfaces support datapaths requiring the following features:

- Low latency, high throughput point-to-point data transfer
- Multiple channel support with flexible packet interleaving
- Sideband signaling of channel, error, and start and end of packet delineation
- Support for data bursting
- Automatic interface adaptation

5.1. Terms and Concepts

The Avalon-ST interface protocol defines the following terms and concepts:

- **Avalon Streaming System**—An Avalon Streaming system contains one or more Avalon-ST connections that transfer data from a source interface to a sink interface. The system shown above consists of Avalon-ST interfaces to transfer data from the system input to output. Avalon-MM control and status register interfaces provide for software control.
- **Avalon Streaming Components**—A typical system using Avalon-ST interfaces combines multiple functional modules, called components. The system designer configures the components and connects them together to implement a system.
- **Source and Sink Interfaces and Connections**—When two components connect, the data flows from the source interface to the sink interface. The *Avalon Interface Specifications* calls the combination of a source interface connecting to a sink interface a *connection*.
- **Backpressure**—Backpressure allows a sink to signal a source to stop sending data. Support for backpressure is optional. The sink uses backpressure to stop the flow of data for the following reasons:
 - When the sink FIFOs are full
 - When there is congestion on its output interface
- **Transfers and Ready Cycles**—A transfer results in data and control propagation from a source interface to a sink interface. For data interfaces, a ready cycle is a cycle during which the sink can accept a transfer.
- **Symbol**—A symbol is the smallest unit of data. For most packet interfaces, a symbol is a byte. One or more symbols make up the single unit of data transferred in a cycle.
- **Channel**—A channel is a physical or logical path or link through which information passes between two ports.
- **Beat**—A beat is a single cycle transfer between a source and sink interface made up of one or more symbols.
- **Packet**—A packet is an aggregation of data and control signals that a source transmits simultaneously. A packet may contain a header to help routers and other network devices direct the packet to the correct destination. The application defines the packet format, not this specification. Avalon-ST packets can be variable in length and can be interleaved across a connection. With an Avalon-ST interfaces, the use of packets is optional.



5.2. Avalon Streaming Interface Signal Roles

Each signal in an Avalon-ST source or sink interface corresponds to one Avalon-ST signal role. An Avalon-ST interface may contain only one instance of each signal role. All Avalon-ST signal roles apply to both sources and sinks and have the same meaning for both.

Table 17. Avalon-ST Interface Signals

In the following table, all signal roles are active high.

Signal Role	Width	Direction	Required	Description
Fundamental Signals				
channel	1 – 128	Source → Sink	No	The <code>channel</code> number for data being transferred on the current cycle. If an interface supports the <code>channel</code> signal, the interface must also define the <code>maxChannel</code> parameter.
data	1 – 4,096	Source → Sink	No	The <code>data</code> signal from the source to the sink, typically carries the bulk of the information being transferred. Parameters further define the contents and format of the <code>data</code> signal.
error	1 – 256	Source → Sink	No	A bit mask to mark errors affecting the data being transferred in the current cycle. A single bit of the <code>error</code> signal masks each of the errors the component recognizes. The <code>errorDescriptor</code> defines the <code>error</code> signal properties.
ready	1	Sink → Source	No	Asserts high to indicate that the sink can accept data. <code>ready</code> is asserted by the sink on cycle <code><n></code> to mark cycle <code><n + readyLatency></code> as a ready cycle. The source may only assert <code>valid</code> and transfer data during <code>ready</code> cycles. Sources without a <code>ready</code> input do not support backpressure. Sinks without a <code>ready</code> output never need to backpressure.
valid	1	Source → Sink	No	The source asserts this signal to qualify all other source to sink signals. The sink samples data and other source-to-sink signals on <code>ready</code> cycles where <code>valid</code> is asserted. All other cycles are ignored. Sources without a <code>valid</code> output implicitly provide valid data on every cycle that a sink is not asserting backpressure. Sinks without a <code>valid</code> input expect valid data on every cycle that they are not backpressuring.
Packet Transfer Signals				
empty	1 – 5	Source → Sink	No	Indicates the number of symbols that are empty, that is, do not represent valid data. The <code>empty</code> signal is not necessary on interfaces where there is one symbol per beat.
endofpacket	1	Source → Sink	No	Asserted by the source to mark the end of a packet.
startofpacket	1	Source → Sink	No	Asserted by the source to mark the beginning of a packet.



5.3. Signal Sequencing and Timing

5.3.1. Synchronous Interface

All transfers of an Avalon-ST connection occur synchronous to the rising edge of the associated clock signal. All outputs from a source interface to a sink interface, including the `data`, `channel`, and `error` signals, must be registered on the rising edge of clock. Inputs to a sink interface do not have to be registered. Registering signals at the source facilitates high frequency operation.

5.3.2. Clock Enables

Avalon-ST components typically do not include a clock enable input. The Avalon-ST signaling itself is sufficient to determine the cycles that a component should and should not be enabled. Avalon-ST compliant components may have a clock enable input for their internal logic. However, components using clock enables must ensure that the timing of the interface adheres to the protocol.

5.4. Avalon-ST Interface Properties

Table 18. Avalon-ST Interface Properties

Property Name	Default Value	Legal Values	Description
<code>associatedClock</code>	1	Clock interface	The name of the Avalon Clock interface to which this Avalon-ST interface is synchronous.
<code>associatedReset</code>	1	Reset interface	The name of the Avalon Reset interface to which this Avalon-ST interface is synchronous.
<code>beatsPerCycle</code>	1	1,2,4,8	Specifies the number of beats that are transferred in a single cycle. This property allows you to transfer 2 separate, but correlated streams using the same <code>start_of_packet</code> , <code>end_of_packet</code> , <code>ready</code> and <code>valid</code> signals. <code>beatsPerCycle</code> is a rarely used feature of the Avalon-ST protocol.
<code>dataBitsPerSymbol</code>	8	1 – 512	Defines the number of bits per symbol. For example, byte-oriented interfaces have 8-bit symbols. This value is not restricted to be a power of 2.
<code>emptyWithinPacket</code>	false	true, false	When true, <code>empty</code> is valid for the entire packet.
<code>errorDescriptor</code>	0	List of strings	A list of words that describe the error associated with each bit of the error signal. The length of the list must be the same as the number of bits in the error signal. The first word in the list applies to the highest order bit. For example, "crc, overflow" means that <code>bit[1]</code> of <code>error</code> indicates a CRC error. <code>Bit[0]</code> indicates an overflow error.
<code>firstSymbolInHighOrderBits</code>	true	true, false	When true, the first-order symbol is driven to the most significant bits of the data interface. The highest-order symbol is labeled <code>D0</code> in this specification. When this property is set to false, the first symbol appears on the low bits. <code>D0</code> appears at <code>data[7:0]</code> . For a 32-bit bus, if true, <code>D0</code> appears on <code>bits[31:24]</code> .
<code>maxChannel</code>	0	0 – 255	The maximum number of channels that a data interface can support.

continued...



Property Name	Default Value	Legal Values	Description
readyLatency	0	0 – 8	Defines the relationship between the assertion of a ready signal and the assertion of a valid signal. If readyLatency = <n> where n > 0, valid can be asserted only <n> cycles after assertion of ready.
readyAllowance ⁽¹⁾	0	0 – 8	Defines the number of transfers that the sink can capture after ready is deasserted. When readyAllowance = 0, the sink cannot accept any transfers after ready is deasserted. If readyAllowance = <n> where <n > 0>, the sink can accept up to <n> transfers after ready is deasserted.
symbolsPerBeat	1	1 – 32	The number of symbols that are transferred on every valid cycle.

5.5. Typical Data Transfers

This section defines the transfer of data from a source interface to a sink interface. In all cases, the data source and the data sink must comply with the specification. The data sink is not responsible for detecting source protocol errors.

5.6. Signal Details

The following figure shows the signals that are typically included in an Avalon-ST interface. As this figure indicates, a typical Avalon-ST source interface drives the valid, data, error, and channel signals to the sink. The sink can apply backpressure using the ready signal.

Figure 21. Typical Avalon-ST Interface Signals

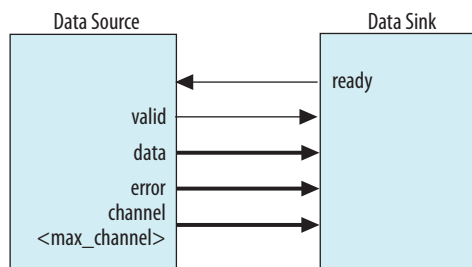

- (1)
- If readyLatency = 0 readyAllowance can be 0 or greater than 0.
 - If readyLatency > 0 readyAllowance must be equal to or greater than readyLatency.
 - If the source or the sink do not specify a value for readyAllowance then readyAllowance= readyLatency. Designs do not require the addition of readyAllowance unless you want the source or the sink to take advantage of this feature.

Here are more details about these signals:

- `ready`—On interfaces supporting backpressure, the sink asserts `ready` to mark the cycles where transfers may take place. If `ready` is asserted on cycle $\langle n \rangle$, cycle $\langle n + \text{readyLatency} \rangle$ is considered a ready cycle.
- `valid`—The `valid` signal qualifies valid data on any cycle where data is being transferred from the source to the sink. On each valid cycle the `data` signal and other source to sink signals are sampled by the sink.
- `data`—The `data` signal typically carries the bulk of the information being transferred from the source to the sink. The `data` signal consists of one or more symbols being transferred on every clock cycle. The `dataBitsPerSymbol` parameter defines how the `data` signal is divided into symbols.
- `error`—Errors are signaled with the `error` signal, where each bit in `error` corresponds to a possible error condition. A value of 0 on any cycle indicates the data on that cycle is error-free. The action that a component takes when an error is detected is not defined by this specification.
- `channel`—The optional `channel` signal is driven by the source to indicate the channel to which the data belongs. The meaning of `channel` for a given interface depends on the application. Some applications use `channel` as an interface number indication. Other applications use `channel` as a page number or timeslot indication. When the `channel` signal is used, all of the data transferred in each active cycle belongs to the same channel. The source may change to a different channel on successive active cycles.

An interface that uses the `channel` signal must define the `maxChannel` parameter to indicate the maximum channel number. If the number of channels an interface supports changes dynamically, `maxChannel` is the maximum number the interface can support.

5.7. Data Layout

Figure 22. Data Symbols

The following figure shows a 64-bit data signal with `dataBitsPerSymbol=16`. Symbol 0 is the most significant symbol.

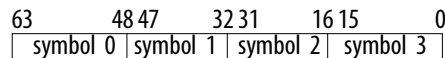
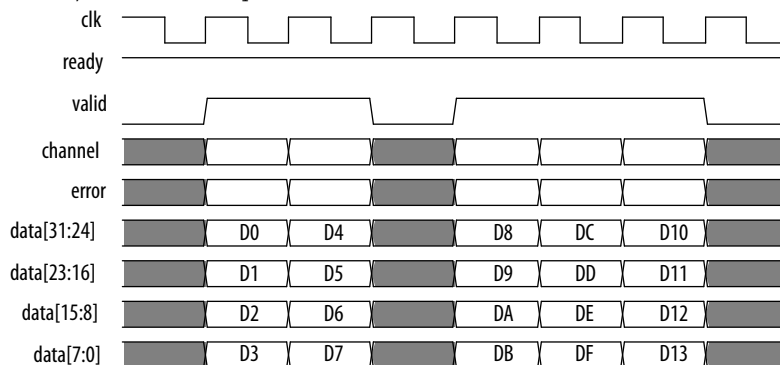



Figure 23. Layout of Data

The timing diagram in the following figure shows a 32-bit example where `dataBitsPerSymbol=8`, `symbolsPerBeat=4`, and `beatsPerCycle=1`.



5.8. Data Transfer without Backpressure

The data transfer without backpressure is the most basic of Avalon-ST data transfers. On any given clock cycle, the source interface drives the data and the optional `channel` and `error` signals, and asserts `valid`. The sink interface samples these signals on the rising edge of the reference clock if `valid` is asserted.

Figure 24. Data Transfer without Backpressure

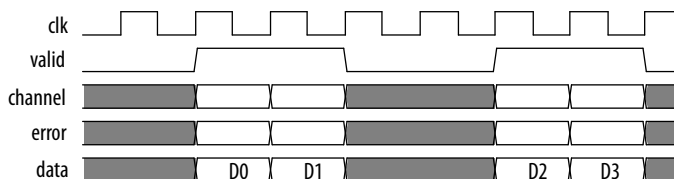

5.9. Data Transfer with Backpressure

The sink asserts `ready` for a single clock cycle to indicate it is ready for an active cycle. Cycles during which the sink is ready for data are called `ready` cycles. During a `ready` cycle, the source may assert `valid` and provide data to the sink. If the source has no data to send, the source deasserts `valid` and can drive data to any value.

Each interface that supports backpressure defines the `readyLatency` parameter to indicate the number of cycles from the time that `ready` is asserted until `valid` data can be driven. If the `readyLatency` is nonzero, cycle $\langle n + \text{readyLatency} \rangle$ is a `ready` cycle if `ready` is asserted on cycle $\langle n \rangle$. Any interface that includes the `ready` signal and defines the `readyLatency` parameter supports backpressure.

When `readyLatency = 0`, data is transferred only when `ready` and `valid` are asserted on the same cycle. In this mode, the source does not receive the sink's `ready` signal before sending `valid` data. The source provides the data and asserts `valid` whenever the source has `valid` data. The source waits for the sink to capture the data and assert `ready`. The source can change the data at any time. The sink only captures input data from the source when `ready` and `valid` are both asserted.

When `readyLatency` ≥ 1 , the sink asserts `ready` before the `ready` cycle itself. The source can respond during the appropriate cycle by asserting `valid`. The source may not assert `valid` during a cycle that is not a `ready` cycle.

`readyAllowance` defines the number of transfers that the sink can capture when `ready` is deasserted. When `readyAllowance` = 0, the sink cannot accept any transfers after `ready` is deasserted. If `readyAllowance` = $\langle n \rangle$ where $n > 0$, the sink can accept up to $\langle n \rangle$ transfers after `ready` is deasserted.

5.9.1. Data Transfers Using `readyLatency` and `readyAllowance`

The following rules apply when transferring data with `readyLatency` and `readyAllowance`.

- If `readyLatency` is 0, `readyAllowance` can be greater than or equal to 0.
- If `readyLatency` is greater than 0, `readyAllowance` can be greater than or equal to `readyLatency`.

When `readyLatency` = 0 and `readyAllowance` = 0, data transfers only when both `ready` and `valid` are asserted. In this case, the source does not receive the sink's `ready` signal before sending `valid` data. The source provides the data and asserts `valid` whenever possible. The source waits for the sink to capture the data and assert `ready`. The source can change the data at any time. The sink only captures input data from the source when `ready` and `valid` are both asserted.

Figure 25. `readyLatency` = 0, `readyAllowance` = 0

When `readyLatency` = 0 and `readyAllowance` = 0 the source can assert `valid` at any time. The sink captures the data from source only when `ready` = 1.

The following figure demonstrates these events:

1. In cycle 1 the source provides data and asserts `valid`.
2. In cycle 2, the sink asserts `ready` and D0 transfers.
3. In cycle 3, D1 transfers.
4. In cycle 4, the sink asserts `ready`, but the source does not drive `valid` data.
5. The source provides data and asserts `valid` on cycle 6.
6. In cycle 8, the sink asserts `ready`, so D2 transfers.
7. D3 transfers at cycle 9 and D4 transfers at cycle 10.

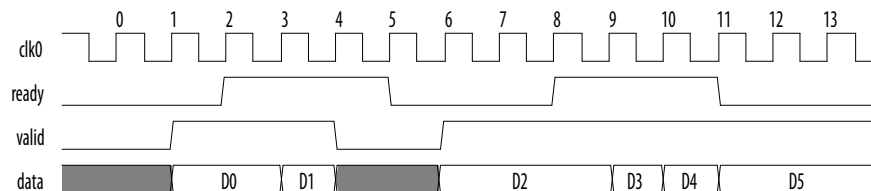



Figure 26. readyLatency = 0, readyAllowance = 1

When `readyLatency = 0` and `readyAllowance = 1` the sink can capture one more data transfer after `ready = 0`.

The following figure demonstrates these events:

1. In cycle 1 the source provides data and asserts `valid` while the sink asserts `ready`. D0 transfers.
2. D1 is transferred in cycle 2.
3. In cycle 3, `ready` deasserts, however since `readyAllowance = 1` one more transfer is allowed, so D2 transfers.
4. In cycle 5 both `valid` and `ready` assert, so D3 transfers.
5. In cycle 6, the source deasserts `valid`, so no data transfers.
6. In cycle 7, `valid` asserts and `ready` deasserts, however since `readyAllowance = 1` one more transfer is allowed, so D4 transfers.

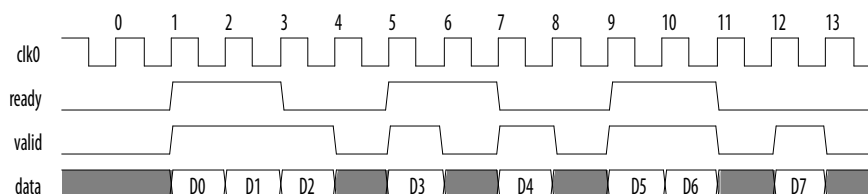
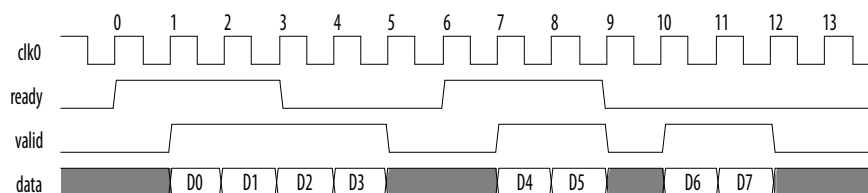

Figure 27. readyLatency = 1, readyAllowance = 2

When `readyLatency = 1` and `readyAllowance = 2` the sink can transfer data one cycle after `ready` asserts, and two more cycles of transfers are allowed after `ready` deasserts.

The following figure demonstrates these events:

1. In cycle 0 the sink asserts `ready`.
2. In cycle 1, the source provides data and asserts `valid`. The transfer occurs immediately.
3. In cycle 3, the sink deasserts `ready`, but the source is still asserting `valid`, and drives valid data because the sink can capture data two cycles after `ready` deasserts.
4. In cycle 10, the sink has deasserted `ready`, but the source asserts `valid` and drives valid data because the sink can capture data two cycles after `ready` deasserts.



Adaptation Requirements

The following table describes whether source and sink interfaces require adaptation.

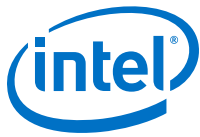

Table 19. Source/Sink Adaptation Requirements

readyLatency	readyAllowance	Adaptation
Source readyLatency = Sink readyLatency	Source readyAllowance = Sink readyAllowance	No adaptation required: The sink can capture all transfers.
	Source readyAllowance > Sink readyAllowance	Adaptation required: After ready is deasserted, the source can send more transfers than the sink can capture.
	Source readyAllowance < Sink readyAllowance	No adaptation required: After ready is deasserted, the sink can capture more transfers than the source can send.
Source readyLatency > Sink readyLatency	Source readyAllowance = Sink readyAllowance	No adaptation required: After ready is asserted, the source starts sending later than the sink can capture. After ready is deasserted, the source can send as many transfers as the sink can capture.
	Source readyAllowance > Sink readyAllowance	Adaptation required: After ready is deasserted, the source can send more transfers than the sink can capture.
	Source readyAllowance < Sink readyAllowance	No adaptation required: After ready is deasserted, the source sends fewer transfers than the sink can capture.
Source readyLatency < Sink readyLatency	Source readyAllowance = Sink readyAllowance	Adaptation required: The source can start sending transfers before sink can capture.
	Source readyAllowance > Sink readyAllowance	Adaptation required: The source can start sending transfers before the sink can capture. Also, after ready is deasserted, the source can send more transfers than the sink can capture.
	Source readyAllowance < Sink readyAllowance	Adaptation required: The source can start sending transfers before the sink can capture.

5.9.2. Data Transfers Using readyLatency

If the source or the sink do not specify a value for readyAllowance then readyAllowance= readyLatency. Designs that use source and sink do not require the addition of readyAllowance unless you want the source or the sink to take advantage of this feature.



Figure 28. Transfer with Backpressure, readyLatency=0

The following figure illustrates these events:

1. The source provides data and asserts `valid` on cycle 1, even though the sink is not ready.
2. The source waits until cycle 2, when the sink does assert `ready`, before moving onto the next data cycle.
3. In cycle 3, the source drives data on the same cycle and the sink is ready to receive data. The transfer occurs immediately.
4. In cycle 4, the sink asserts `ready`, but the source does not drive valid data.

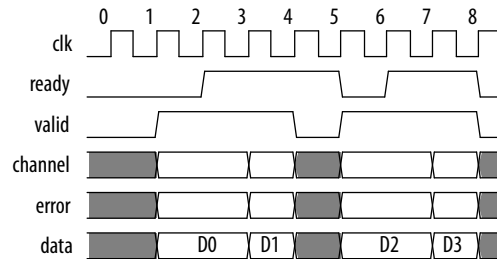

Figure 29. Transfer with Backpressure, readyLatency=1

The following figures show data transfers with `readyLatency=1` and `readyLatency=2`, respectively. In both these cases, `ready` is asserted before the ready cycle, and the source responds 1 or 2 cycles later by providing data and asserting `valid`. When `readyLatency` is not 0, the source must deassert `valid` on non-ready cycles.

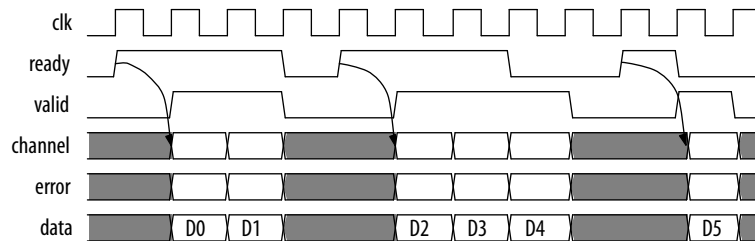
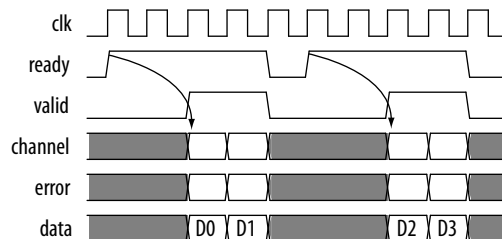

Figure 30. Transfer with Backpressure, readyLatency=2



5.10. Packet Data Transfers

The packet transfer property adds support for transferring packets from a source interface to a sink interface. Three additional signals are defined to implement the packet transfer. Both the source and sink interfaces must include these additional signals to support packets. You can only connect source and sink interfaces with

matching packet properties. Platform Designer does not automatically add the `startofpacket`, `endofpacket`, and `empty` signals to source or sink interfaces that do not include these signals.

Figure 31. Avalon-ST Packet Interface Signals

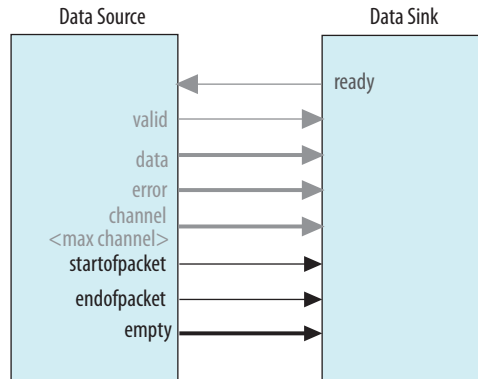

5.11. Signal Details

- `startofpacket`—All interfaces supporting packet transfers require the `startofpacket` signal. `startofpacket` marks the active cycle containing the start of the packet. This signal is only interpreted when `valid` is asserted.
- `endofpacket`—All interfaces supporting packet transfers require the `endofpacket` signal. `endofpacket` marks the active cycle containing the end of the packet. This signal is only interpreted when `valid` is asserted. `startofpacket` and `endofpacket` can be asserted in the same cycle. No idle cycles are required between packets. The `startofpacket` signal can follow immediately after the previous `endofpacket` signal.
- `empty`—The optional `empty` signal indicates the number of symbols that are empty during the `endofpacket` cycle. The sink only checks the value of the `empty` during active cycles that have `endofpacket` asserted. The empty symbols are always the last symbols in `data`, those carried by the low-order bits when `firstSymbolInHighOrderBits = true`. The `empty` signal is required on all packet interfaces whose `data` signal carries more than one symbol of data and have a variable length packet format. The size of the `empty` signal in bits is $\text{ceil}[\log_2(\text{<symbols per cycle>})]$.



5.12. Protocol Details

Packet data transfer follows the same protocol as the typical data transfer with the addition of the `startofpacket`, `endofpacket`, and `empty`.

Figure 32. Packet Transfer

The following figure illustrates the transfer of a 17-byte packet from a source interface to a sink interface, where `readyLatency=0`. This timing diagram illustrates the following events:

1. Data transfer occurs on cycles 1, 2, 4, 5, and 6, when both `ready` and `valid` are asserted.
2. During cycle 1, `startofpacket` is asserted. The first 4 bytes of packet are transferred.
3. During cycle 6, `endofpacket` is asserted. `empty` has a value of 3. This value indicates that this is the end of the packet and that 3 of the 4 symbols are empty. In cycle 6, the high-order byte, `data[31:24]` drives valid data.

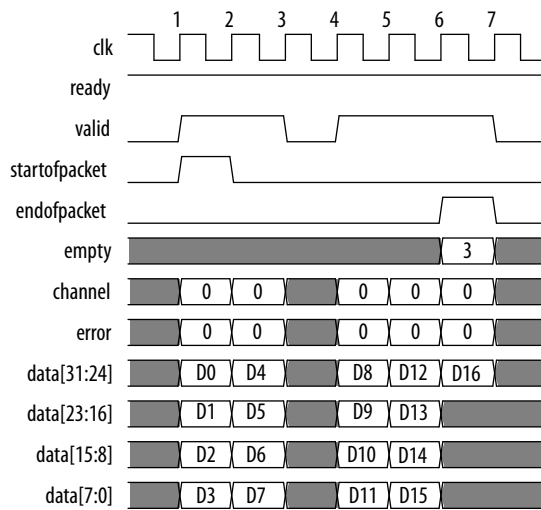

6. Avalon Conduit Interfaces

Avalon Conduit interfaces group an arbitrary collection of signals. You can specify any role for conduit signals. However, when you connect conduits, the roles and widths must match and the directions must be opposite. An Avalon Conduit interface can include input, output, and bidirectional signals. A module can have multiple Avalon Conduit interfaces to provide a logical signal grouping. Conduit interfaces can declare an associated clock. When connected conduit interfaces are in different clock domains, Platform Designer generates an error message.

Note: If possible, you should use the standard Avalon-MM or Avalon-ST interfaces instead of creating an Avalon Conduit interface. Platform Designer provides validation and adaptation for these interfaces. Platform Designer cannot provide validation or adaptation for Avalon Conduit interfaces.

Conduit interfaces typically used to drive off-chip device signals, such as an SDRAM address, data and control signals.

Figure 33. Focus on the Conduit Interface

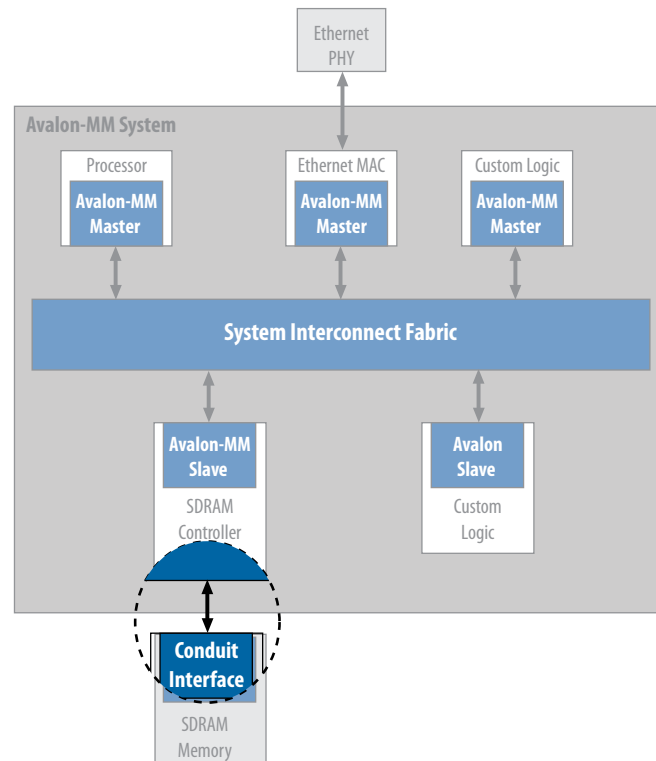

Intel Corporation. All rights reserved. Intel, the Intel logo, Altera, Arria, Cyclone, Enpirion, MAX, Nios, Quartus and Stratix words and logos are trademarks of Intel Corporation or its subsidiaries in the U.S. and/or other countries. Intel warrants performance of its FPGA and semiconductor products to current specifications in accordance with Intel's standard warranty, but reserves the right to make changes to any products and services at any time without notice. Intel assumes no responsibility or liability arising out of the application or use of any information, product, or service described herein except as expressly agreed to in writing by Intel. Intel customers are advised to obtain the latest version of device specifications before relying on any published information and before placing orders for products or services.

*Other names and brands may be claimed as the property of others.



6.1. Avalon Conduit Signal Roles

Table 20. Conduit Signal Roles

Signal Role	Width	Direction	Description
<any>	<n>	In, out, or bidirectional	A conduit interface consists of one or more input, output, or bidirectional signals of arbitrary width. Conduits can have any user-specified role. You can connect compatible Conduit interfaces inside a Platform Designer (Standard) system provided the roles and widths match and the directions are opposite.

6.2. Conduit Properties

There are no properties for conduit interfaces.

7. Avalon Tristate Conduit Interface

The Avalon Tristate Conduit Interface (Avalon-TC) is a point-to-point interface designed for on-chip controllers that drive off-chip components. This interface allows data, address, and control pins to be shared across multiple tristate devices. Sharing conserves pins in systems that have multiple external memory devices.

The Avalon-TC interface restricts the more general Avalon Conduit Interface in two ways:

- The Avalon-TC requires `request` and `grant` signals. These signals enable bus arbitration when multiple Tristate Conduit Masters (TCM) are requesting access to a shared bus.
- The pin type of a signal must be specified using suffixes appended to a signal's role. The three suffixes are: `_out`, `_in`, and `_outen`. Matching role prefixes identify signals that share the same I/O Pin. The following illustrates the naming conventions for Avalon-TC shared pins.

Figure 34. Shared Pin Types

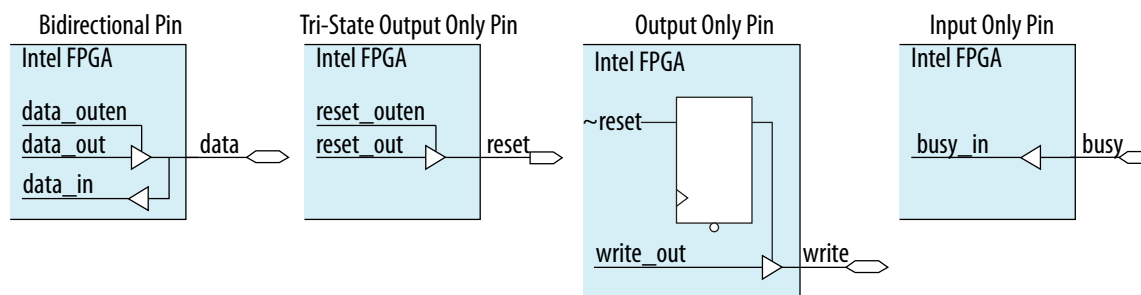



The next figure illustrates pin sharing using Avalon-TC interfaces. This figure illustrates the following points.

- The Tristate Conduit Pin Sharer includes separate Tristate Conduit Slave Interfaces for each Tristate Conduit Master. Each master and slave pair has its own `request` and `grant` signals.
- The Tristate Conduit Pin Sharer identifies signals with identical roles as tristate signals that share the same FPGA pin. In this example, the following signals are shared: `addr_out`, `data_out`, `data_in`, `read_out`, and `write_out`.
- The Tristate Conduit Pin Sharer drives a single bus including all of the shared signals to the Tristate Conduit Bridge. If the widths of shared signals differ, the Tristate Conduit Pin Sharer aligns them on their 0th bit. Tristate Conduit Pin Sharer drives the higher-order pins to 0 whenever the smaller signal has control of the bus.
- Signals that are not shared propagate directly through the Tristate Conduit Pin Sharer. In this example, the following signals are not shared: `chipselct0_out`, `irq0_out`, `chipselct1_out`, and `irq1_out`.
- All Avalon-TC interfaces connected to the same Tristate Conduit Pin Sharer must be in the same clock domain.

Figure 35. Tristate Conduit Interfaces

The following illustrates the typical use of Avalon-TC Master and Slave interfaces and signal naming.

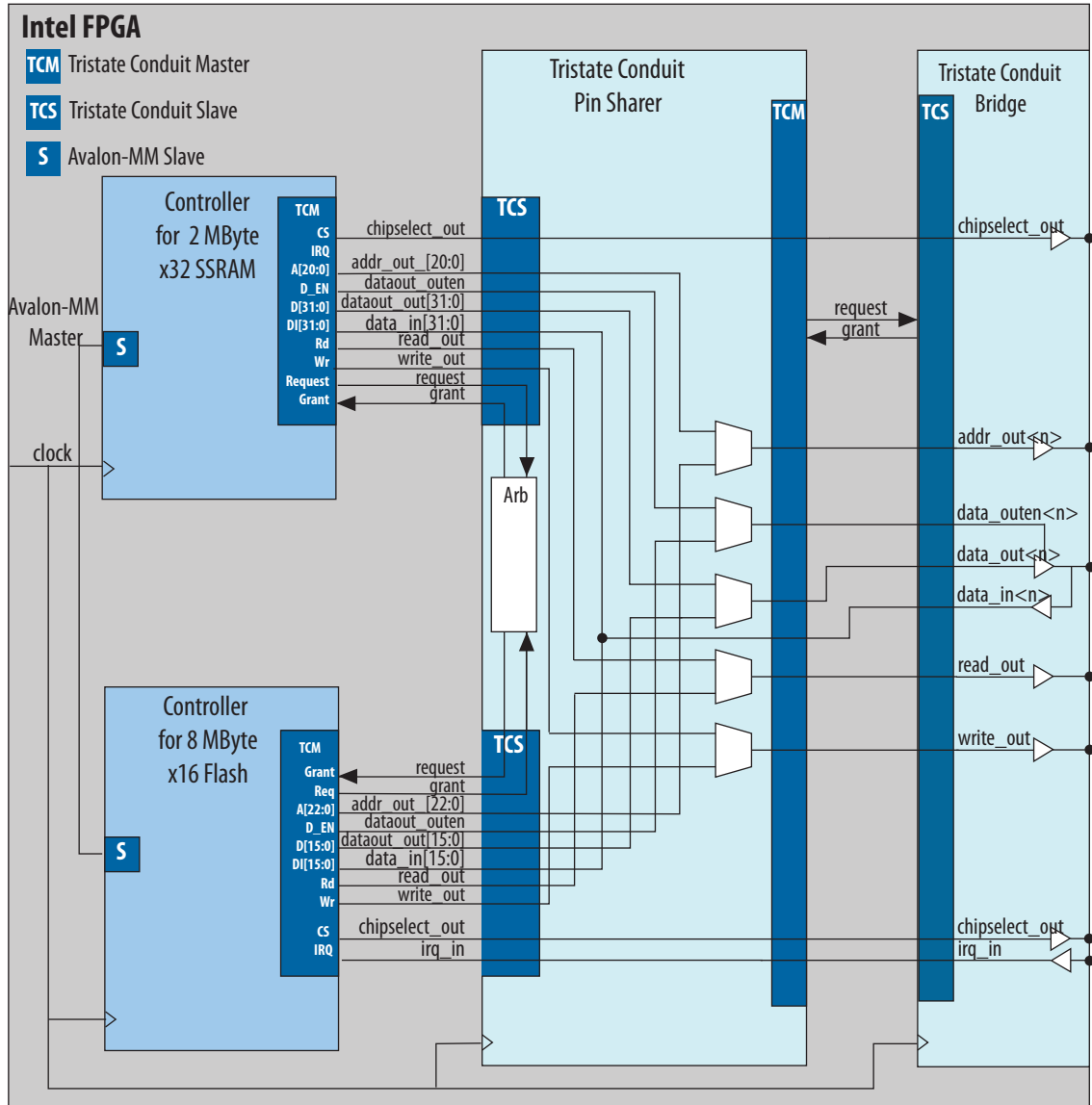

For more information about the Generic Tristate Controller and Tristate Conduit Pin Sharer, refer to the *Avalon Tristate Conduit Components User Guide*.

Related Information

[Avalon Tristate Conduit Components User Guide](#)

7.1. Avalon Tristate Conduit Signal Roles

The following table lists the signal defined for the Avalon Tristate Conduit interface. All Avalon-TC signals apply to both masters and slaves and have the same meaning for both



Table 21. Tristate Conduit Interface Signal Roles

Signal Role	Width	Direction	Required	Description
request	1	Master → Slave	Yes	<p>The meaning of <code>request</code> depends on the state of the <code>grant</code> signal, as the following rules dictate.</p> <p>When <code>request</code> is asserted and <code>grant</code> is deasserted, <code>request</code> is requesting access for the current cycle.</p> <p>When <code>request</code> is asserted and <code>grant</code> is asserted, <code>request</code> is requesting access for the next cycle. Consequently, <code>request</code> should be deasserted on the final cycle of an access.</p> <p>The <code>request</code> signal deasserts in the last cycle of a bus access. The <code>request</code> signal can reassert immediately following the final cycle of a transfer. This protocol makes both rearbitration and continuous bus access possible if no other masters are requesting access.</p> <p>Once asserted, <code>request</code> must remain asserted until granted. Consequently, the shortest bus access is 2 cycles. Refer to <i>Tristate Conduit Arbitration Timing</i> for an example of arbitration timing.</p>
grant	1	Slave → Master	Yes	<p>When asserted, indicates that a tristate conduit master has access to perform transactions. The <code>grant</code> signal asserts in response to the <code>request</code> signal. The <code>grant</code> signal remains asserted until 1 cycle following the deassertion of <code>request</code>.</p>
<name>_in	1 - 1024	Slave → Master	No	The input signal of a logical tristate signal.
<name>_out	1 - 1024	Master → Slave	No	The output signal of a logical tristate signal.
<name>_outen	1	Master → Slave	No	The output enable for a logical tristate signal.

7.2. Tristate Conduit Properties

There are no special properties for the Avalon-TC Interface.

7.3. Tristate Conduit Timing

The following illustrates arbitration timing for the Tristate Conduit Pin Sharer. Note that a device can drive or receive valid data in the granted cycle.



Figure 36. Tristate Conduit Arbitration Timing

This figure shows the following sequence of events:

1. In cycle 1, the tristate conduit slave asserts grant. The slave drives valid data in cycles 1 and 2.
2. In cycle 4, the tristate conduit slave asserts grant. The slave drives valid data in cycles 5–8.
3. In cycle 9, the tristate conduit slave asserts grant. The slave drives valid data in cycles 10–17.
4. Cycles 3, 4 and 9 do not contain valid data.

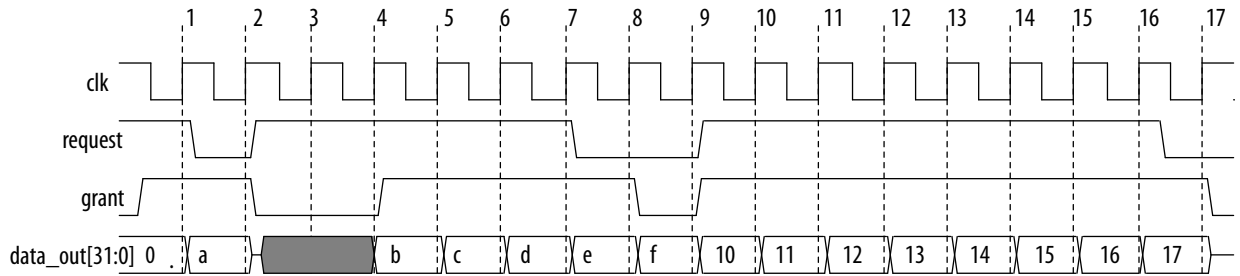



A. Deprecated Signals

Deprecated signals implement functionality that is no longer required or has been superseded.

begintransfer

An output of Avalon-MM masters. Asserted for a single cycle at the beginning of a transfer. This signal is not used and not necessary.

chipselct or chipselct_n

`chipselct` or `chipselct_n`: The chip select signal as described below was deprecated with the release of the Avalon Tristate Conduct (Avalon-TC) interface type which includes a chip select signal.

Formerly `chipselct` was a 1-bit input to an Avalon Memory-Mapped (Avalon-MM) slave interface signaling the beginning of a read or write transfer. The current Platform Designer interconnect filters read and write signals from masters according to the address and address map. The Platform Designer interconnect only drives read and write signals to the appropriate Avalon-MM slave, making a chip select unnecessary.

This signal dates from very early microprocessor designs. CPLDs decoded microprocessor addresses and generated chip selects for peripherals that typically were frequently asynchronous. With synchronous systems this signal is typically unnecessary.

flush

This signal was removed version 1.2 of the *Avalon Interface Specifications*. Formerly available to masters to clear pending transfers for pipelined reads.



B. Document Revision History for the Avalon Interface Specifications

Document Version	Intel Quartus Prime Version	Changes
2018.05.22	18.0	Made the following changes: <ul style="list-style-type: none"> In the <i>Avalon-ST Interface Properties</i> table, corrected the default value for <code>beatsPerCycle</code>. The default value is 1. In the <i>Avalon-ST Interface Properties</i> table, added legal values for <code>beatsPerCycle</code>. Legal values are 1, 2, 4, and 8. Corrected minor errors and typos.
2018.05.07	18.0	Made the following changes: <ul style="list-style-type: none"> Added support for the <code>readyAllowance</code> parameter. Updated the <i>Data Transfers with Backpressure</i> topic to incorporate support for the <code>readyAllowance</code> parameter. Fixed minor errors and typos.
2018.03.22	17.1	Made the following changes: <ul style="list-style-type: none"> Made the following changes to the <i>Read and Write Transfers with Waitrequest</i> timing diagram <ul style="list-style-type: none"> Removed <code>readdatavalid</code> signal which is not relevant when using <code>waitrequest</code> Moved the number 4, <code>readdata</code> and <code>response</code> forward one cycle. Aligned the <code>read</code> signal to number 1. Expanded the <i>Transfers Using the waitrequestAllowance Property</i> section. Provided more complex timing diagrams. Updated the discussion in the <i>Read Bursts</i> section. For reads with a <code>burstcount > 1</code>, Intel recommends asserting all <code>byteenables</code>. Enhanced discussion in the <i>waitrequestAllowance Equals Two - Not Recommended</i> topic. Corrected timing diagram. Data must be held for 2 cycles starting at clock cycle 11.
November 2017	17.1	Made the following changes:

continued...

Intel Corporation. All rights reserved. Intel, the Intel logo, Altera, Arria, Cyclone, Enpirion, MAX, Nios, Quartus and Stratix words and logos are trademarks of Intel Corporation or its subsidiaries in the U.S. and/or other countries. Intel warrants performance of its FPGA and semiconductor products to current specifications in accordance with Intel's standard warranty, but reserves the right to make changes to any products and services at any time without notice. Intel assumes no responsibility or liability arising out of the application or use of any information, product, or service described herein except as expressly agreed to in writing by Intel. Intel customers are advised to obtain the latest version of device specifications before relying on any published information and before placing orders for products or services.

*Other names and brands may be claimed as the property of others.

ISO
9001:2008
Registered

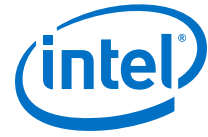

Document Version	Intel Quartus Prime Version	Changes
		<ul style="list-style-type: none"> Updated the discussion of <i>Read Bursts</i> as follows: <ul style="list-style-type: none"> Qualified the statement, " When a master connects directly to a slave, a burstcount of <n>, means the slave must return <n> words of readdata to complete the burst. " This statement is true if the master connects directly to the slave. It may not be true if interconnect links the master and slave. Removed the following statement from the description of read bursts: "The byteenables presented with a read burst command apply to all cycles of the burst." This statement is no longer true. However, Intel recommends that reads with burstcount > 1 assert all byteenables. Removed the following statement from the <i>Pipelined Transfers</i> section: <i>Write transfers cannot be pipelined.</i> You can pipeline writes using the writeresponsevalid signal. Expanded the description of read and write responses in the <i>Avalon-MM Read and Write Responses Timing Diagram</i> section. Revised the description of the reset_req signal. Changed width of irq from 1 bit to 1-32 bits. Both the Intel Quartus Prime Pro Edition and Intel Quartus Prime Standard Edition software support interrupt vectors.
May 2017	Quartus Prime Pro v17.1 Stratix 10 ES Editions	<p>Made the following changes:</p> <ul style="list-style-type: none"> Added the following interface property parameters. <ul style="list-style-type: none"> waitrequestAllowance parameter to support high speed operation. This parameter is available for Avalon-MM interfaces. Added timing diagrams illustrating use of this parameter. minimumResponseLatency parameter to facilitate timing closure for Avalon-MM interface. Added timing diagrams illustrating use of this parameter.
December 2015	15.1	<p>Made the following changes:</p> <ul style="list-style-type: none"> Changed the width of the empty signal from a maximum of 8 bits to a maximum of 5 bits. Improved the definition of the reset_req signal. Removed the readdatavalid signal from the <i>Pipelined Read Transfer with Fixed Latency of Two Cycles</i> timing diagram. This signal is not relevant for fixed latency transfers. Corrected equation defining the empty signal. Made the following changes in the <i>Pipelined Read Transfers with Variable Latency</i> timing diagram: <ul style="list-style-type: none"> Moved the deassertion of the read signal to cycle 9 Changed waitrequest to don't care in cycle 9.
March 2015	14.1	Fixed typo in Figure 1-1.
January 2015	14.1	<p>Made the following changes:</p> <ul style="list-style-type: none"> Clarified address alignment example. The Avalon-MM master and slave interfaces are different widths. Improved discussion of <i>Pipelined read Transfers with Variable Latency</i>. Corrected timing marker 2 which should be exactly on the rising edge of clock. Improved discussion of <i>Pipelined Read Transfer with Fixed Latency of Two Cycles</i>. Clarified use of beatsPerCycle property. Corrected the address range for line-wrapped bursts. The correct address range for a 64-byte burst is 0x0-0x3C, not 0x0-0x1C.

continued...



Document Version	Intel Quartus Prime Version	Changes
		<ul style="list-style-type: none"> Corrected description of the <i>Tristate Conduit Arbitration Timing</i> diagram in the following ways: <ul style="list-style-type: none"> The tristate conduit slave asserts grant, not the tristate conduit master. The final grant comes in cycle 9, not cycle 8. Added a <i>Deprecated Signals</i> appendix. Added read response signal. Improved definitions of clock and reset signal types. Corrected definition of clock sink properties. Corrected definition of <code>synchronousEdges</code> for reset source interface. Clarified the Avalon-MM response signal type. Updated definition of <code>empty</code>. The signal must be interpreted <code>emptyWithinPacket</code> is true. Edited for clarity and consistency.
June 2014	14.0	<ul style="list-style-type: none"> Updated the Avalon-MM Signals table, <code>begintransfer</code>, <code>readdatavalid</code>, and <code>readdatavalid_n</code>. Updated the Read and Write Transfers with Waitrequest figure: <ul style="list-style-type: none"> Moved deassertion of write to cycle 6. Moved assertion of <code>readdatavalid</code> and <code>readdata</code> to cycle 4. Updated the Pipelined Read Transfers with Variable Latency figure: <ul style="list-style-type: none"> Moved assertion of <code>data1</code> to just after cycle 5, and assertion of <code>data2</code> to cycle 6. Moved assertion of <code>readdatavalid</code> to match <code>data1</code> and <code>data2</code>.
April 2014	13.01	Corrected <i>Read and Write Transfers with Waitrequest In Avalon Memory-Mapped Interfaces</i> chapter .
May 2013	13.0	Made the following changes: <ul style="list-style-type: none"> Minor updates to <i>Avalon Memory-Mapped Interfaces</i>. Minor updates to <i>Avalon Streaming Interfaces</i>. Updated <i>Avalon Conduit Interfaces</i> to describe the signal roles supported by Avalon conduit interfaces. Updated <i>Shared Pin Types</i> figure in the <i>Avalon Tristate Conduit Interface</i> chapter.
May 2011	11.0	Initial release of the <i>Avalon Interface Specifications</i> supported by Platform Designer (Standard).